

BYTEM-123-PC

Industrial Panel PC for Railway

User's Manual

Version 1.0
(July 2016)



Copyright

© 2016 IBASE Technology, Inc. All rights reserved.

No part of this publication may be reproduced, copied, stored in a retrieval system, translated into any language or transmitted in any form or by any means, electronic, mechanical, photocopying, or otherwise, without the prior written consent of IBASE Technology, Inc. (hereinafter referred to as "IBASE").

Disclaimer

IBASE reserves the right to make changes and improvements to the products described in this document without prior notice. Every effort has been made to ensure the information in the document is correct; however, IBASE does not guarantee this document is error-free. IBASE assumes no liability for incidental or consequential damages arising from misapplication or inability to use the product or the information contained herein, nor for any infringements of rights of third parties, which may result from its use.

Trademarks

All the trademarks, registrations and brands mentioned herein are used for identification purposes only and may be trademarks and/or registered trademarks of their respective owners.

Compliance

CE

This is a class A product. In a domestic environment, this product may cause radio interference in which case users may be required to take adequate measures.

FCC

This product has been tested and found to comply with the limits for a Class B device, pursuant to Part 15 of the FCC Rules. These limits are designed to provide reasonable protection against harmful interference in a residential installation. This equipment generates, uses and can radiate radio frequency energy and, if not installed and used in accordance with manufacturer's instructions, may cause harmful interference to radio communications.

Operation is subject to the following two conditions:

- This product may not cause harmful interference
- This product must accept any interference received including interference that may cause undesired operation.

However, there is no guarantee that interference will not occur in a particular installation. If this equipment causes harmful interference to radio or television reception which can be determined by turning the equipment off and on, you may correct the interference by one or more of the following measures:

- Reorient or relocate the receiving antenna.
- Increase the separation between the equipment and the receiver.
- Connect the equipment to an outlet on a circuit different from that to which the receiver is connected.
- Consult the distributor or an experienced radio/TV technician for help.

WEEE



This product must not be disposed of as normal household waste, in accordance with the EU directive of for waste electrical and electronic equipment (WEEE - 2012/19/EU). Instead, it should be disposed of by returning it to a municipal recycling collection point. Check local regulations for disposal of electronic products.

Green iBASE



This product is compliant with the current RoHS restrictions and prohibits use of the following substances in concentrations exceeding 0.1% by weight (1000 ppm) except for cadmium, limited to 0.01% by weight (100 ppm).

- Lead (Pb)
- Mercury (Hg)
- Cadmium (Cd)
- Hexavalent chromium (Cr6+)
- Polybrominated biphenyls (PBB)
- Polybrominated diphenyl ether (PBDE)

Important Safety Information

Carefully read the precautions before using the device.

Environmental conditions:

- Lay the device horizontally on a stable and solid surface during installation in case the device may fall, causing serious damage.
- Leave plenty of space around the device for ventilation.
- Use this product in environments with ambient temperatures between -25°C and 55°C.
- DO NOT LEAVE THIS DEVICE IN AN ENVIRONMENT WHERE THE STORAGE TEMPERATURE MAY BE BELOW -30° C OR ABOVE 70° C. To prevent from damages, the device must be used in a controlled environment.
- Keep the device away from humidity to avoid fog or condensation from accumulating on the inner surface of the panel.

Care for your iBASE products:

- Before cleaning the device, turn it off and unplug all cables such as power in case a small amount of electrical current may still flow.
- Use neutral cleaning agents or diluted alcohol to clean the device chassis with a cloth. Then wipe the chassis with a dry cloth.
- Vacuum the dust with a computer vacuum cleaner to prevent the air vent or slots from being clogged.



WARNING

Attention during use:

- Operate with fingers on the panel. Sharp-pointed articles are prohibited.
- Do not use this product near water.
- Do not spill water or any other liquids on your device.
- Do not place heavy objects on the top of the device.
- Operate this device from the type of power indicated on the marking label. If you are not sure of the type of power available, consult your distributor or local power company.
- Do not walk on the power cord or allow anything to rest on it.
- If you use an extension cord, make sure that the total ampere rating of the product plugged into the extension cord does not exceed its limits.

Avoid Disassembly

You are not suggested to disassemble, repair or make any modification to the device. Disassembly, modification, or any attempt at repair could generate hazards and cause damage to the device, even bodily injury or property damage, and will void any warranty.

Warranty Policy

- **IBASE standard products:**
24-month (2-year) warranty from the date of shipment. If the date of shipment cannot be ascertained, the product serial numbers can be used to determine the approximate shipping date.
- **3rd-party parts:**
12-month (1-year) warranty from delivery for the 3rd-party parts that are not manufactured by IBASE, such as CPU, CPU cooler, memory, storage devices, power adapter, panel and touchscreen.
- * Products, however, that fail due to misuse, accident, improper installation or unauthorized repair shall be treated as out of warranty and customers shall be billed for repair and shipping charges.

Technical Support & Services

1. Visit the IBASE website at www.ibase.com.tw to find the latest information about the product.
2. If you need any further assistance from your distributor or sales representative, prepare the following information of your product and elaborate upon the problem.
 - Product model name
 - Product serial number
 - Detailed description of the problem
 - The error messages in text or in screenshots if there is any
 - The arrangement of the peripherals
 - Software in use (such as OS and application software, including the version numbers)
3. If repair service is required, you can download the RMA form at <http://www.ibase.com.tw/english/Supports/RMAService/>. Fill out the form and contact your distributor or sales representative.

Table of Contents

Compliance.....	iii
Important Safety Information	iv
WARNING	v
Warranty Policy.....	v
Technical Support & Services	vi
Chapter 1 General Information.....	1
1.1 Introduction	2
1.2 Features.....	2
1.3 Packing List	3
1.4 Specifications.....	4
1.5 Overview.....	6
1.6 Dimensions	8
Chapter 2 Hardware Installation & Motherboard Information	10
2.1 Hardware Installation	11
2.1.1 Membrane Keypad Extension.....	11
2.1.2 Memory Installation	14
2.1.3 VESA Mount & Wall Mount Installation	15
2.2 Setting the Jumpers	16
2.2.1 How to Set Jumpers	16
2.3 Jumper & Connector Locations on Motherboard	17
2.4 Jumpers Quick Reference.....	19
2.4.1 LVDS Panel Power Selection (J5).....	19
2.4.2 LVDS Panel Brightness Control Selection (JP2)	20
2.4.3 ME Register Clearance (JP5).....	20
2.4.4 CMOS Data Clearance (JP6).....	21
2.5 Connectors Quick Reference	22
2.5.1 Motherboard Power Button (SW1)	23
2.5.2 LED Indicators for Power and HDD (LED1).....	23
2.5.3 SATA II / mSATA Port (CN1)	23
2.5.4 SATA II Port (CN2).....	24
2.5.5 USB 3.0 Port (CN3).....	24
2.5.6 LAN Port (GbE) (CN4, CN5)	24

2.5.7	USB 2.0 Port (CN6).....	25
2.5.8	Display Port (CN7).....	25
2.5.9	COM1 Port (RS-232/422/485) (CN8)	26
2.5.10	Audio Connector (J1).....	27
2.5.11	Amplifier Connector (J2).....	27
2.5.12	DDR3L SO-DIMM Socket (J3, J7).....	28
2.5.13	LVDS Connector (J4, J6).....	28
2.5.14	SATA HDD Power Connector (J10).....	29
2.5.15	Smart Battery Connector (J11).....	29
2.5.16	Full-Sized Mini-PCIe / mSATA Connector (J12).....	30
2.5.17	Half-Sized Mini-PCIe Connector (J13).....	30
2.5.18	USB 2.0 Connector (J14).....	30
2.5.19	COM2 (RS-232) Port (J15).....	31
2.5.20	VGA Port (J16).....	31
2.5.21	Digital I/O Connector (J17).....	32
2.5.22	Motherboard Power Input Connector (J18)	32
2.5.23	Reset Switch Connector (J19).....	33
2.5.24	Power Switch Connector (J20).....	33
2.5.25	LCD Backlight Connector (JP3).....	34
2.5.26	System Fan Power Connector (SYS_FAN1).....	34
Chapter 3 Driver Installation		35
3.1	Introduction.....	36
3.2	Intel® Chipset Software Installation Utility.....	37
3.3	VGA Driver Installation.....	38
3.4	HD Audio Driver Installation	39
3.5	Intel® Trusted Execution Engine Installation	40
Chapter 4 BIOS Setup.....		41
4.1	Introduction.....	42
4.2	BIOS Setup.....	42
4.3	Main Settings	43
4.4	Advanced Settings	44
4.4.1	ACPI Settings	45
4.4.2	LVDS Configuration.....	46
4.4.3	iSMART Controller.....	47
4.4.4	Super IO Configuration	48
4.4.5	Hardware Monitor	49
4.4.6	CPU Configuration.....	50
4.4.7	CPU PPM Configuration	51
4.4.8	IDE Configuration	52

4.4.9	SDIO Configuration	53
4.4.10	USB Configuration	54
4.5	Chipset Settings	55
4.5.1	North Bridge	55
4.6	Security Settings	56
4.7	Boot Settings.....	57
4.8	Save & Exit Settings.....	58
Appendix		59
A.	I/O Port Address Map.....	60
B.	Interrupt Request Lines (IRQ)	61
C.	Digital I/O Sample Code.....	62
D.	Watchdog Timer Configuration.....	67

Chapter 1

General Information

The information provided in this chapter includes:

- Features
- Packing List
- Specifications
- Overview
- Dimensions

1.1 Introduction

BYTEM-123-PC is a 12.1" industrial projected touch panel PC that is railway compliant. With Intel® Atom™ E3845 Quad-Core based processor, the device carries the level of IP65 ingress protection for the panel to provide good quality of water-tight. The readability is especially enhanced for operating on rolling shock on the railway. It is able to be operated at the ambient operating temperature ranging from -25 to 55 °C, and even from -30 to 70 °C for storage.

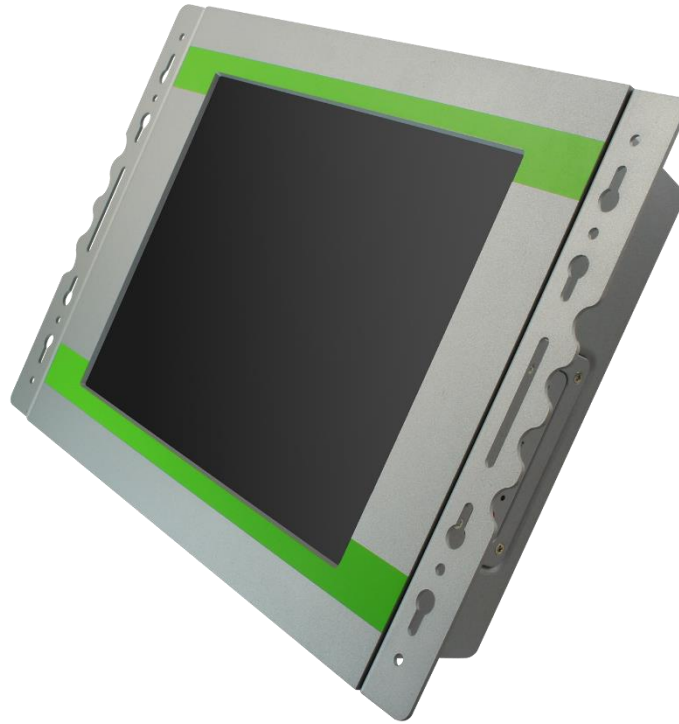

1.2 Features

- Intel® Atom™ E3845 Quad-Core Processor
- EN50155 certified railway application
- 24V DC power input, available options of 48V DC, 72V DC or 110V DC
- IP65 protection for the front panel and IP54 for the whole unit
- Projected capacitive touchscreen with optical bonding

1.3 Packing List

Your BYTEM-123-PC package should include the items listed below. If any of the items below is missing, contact the distributor or the dealer from whom you purchased the product.

- BYTEM-123-PC x 1
- Keypad Cover x 1
- Extension Cable (for Membrane Keypad) x 1
- LAN Cable x 2
- USB Cable x 1
- Power Cable x 1
- Disk x 1
- Terminal Block x 1
- Rack Mount Kit x 1
- M3 Screw (for Rack Mount Kit) x 8
- M4 Screw (for wall mount installation) x 6

1.4 Specifications

Product Name	BYTEM-123-PC
System	
Motherboard	IB897
Operating System	<ul style="list-style-type: none"> • Windows 8 (32-bit / 64-bit) • Windows 7 Pro for Embedded (64-bit) • Windows Embedded Standard 7 (64-bit)
CPU	Intel® Atom™ E3845 Quad-Core (1.91 GHz)
Chipset	Integrated
Memory	1 x DDR3L SO-DIMM 4 GB, expandable up to 8GB
Graphics	Intel® HD graphics Gen. 7 with 4EU Supports DX 11, OGL 3.0, OCL 1.1, OGL ES 2.0
Super I/O	Nuvoton NCT5523D
LVDS	Dual channel 24-bit
Audio Codec	Realtek ALC662, two-way audio
Membrane Control	1 x Membrane Control Keypad (Power, Brightness+, Brightness-, Volume+, Volume-, Power LED, HDD LED)
Power Supply	24V DC-In (Optional: 48V DC, 72V DC & 110V DC)
BIOS	AMI BIOS
Watchdog	Watchdog Timer 256 segments, 0, 1, 2...255 sec/min
iSMART	iSMART 2.0 (auto-scheduler / power resume)
Chassis	Aluminum front bezel and back cover
Mounting	VESA 75 x 75 mm
Dimensions (W x H x D)	335 x 267 x 72.1 mm (13.18" x 10.5" x 28.39")
Net Weight	3.6 kg (7.94 lb)
Ingress Protection	IP65 for front bezel IP54 for the whole unit with I/O cover
Certificate	CE, FCC Class B, EN50155

Panel	
Display Type	12.1" TFT-LCD
Touch Type	Projected capacitive touch
Resolution	Max. 1024 x 768
Color	Max. 16.7M
View Angle (H/V)	170° / 170°
Light Transmission	90 %
Luminance	350 cd/m2
Contrast	800:1
Backlight Lifetime	30000 hrs
I/O Ports	
LAN	Intel® I210IT <ul style="list-style-type: none"> • 2 x Gigabit Ethernet (RJ45) • 2 x 10/100 Mbps LAN (M12 D-code)
USB	<ul style="list-style-type: none"> • 1 x USB 3.0 • 1 x USB 2.0 (Type A) • 1 x USB 2.0 (M12 A-code)
Serial	<ul style="list-style-type: none"> • 1 x COM1 port (RS-232/422/485) for jumper-less selection • 1 x COM2 (RS-232 only)
Storage	1 x 2.5" drive bay for SATA II HDD
SATA	2 x SATA II connector
Display	1 x Display Port
Audio	2 x internal speaker
Digital I/O	4 in & 4 out
Expansion	1 x Mini PCIe (x1) slot (half-sized) with USB
Environment	
Temperature	<ul style="list-style-type: none"> • Operating: 25 ~ 55 °C (-13 ~ 131 °F) • Storage: -30 ~ 70 °C (-22 ~ 158 °F)
Relative Humidity	10 ~ 90% (non-condensing)

All specifications are subject to change without prior notice.

1.5 Overview

Oblique View

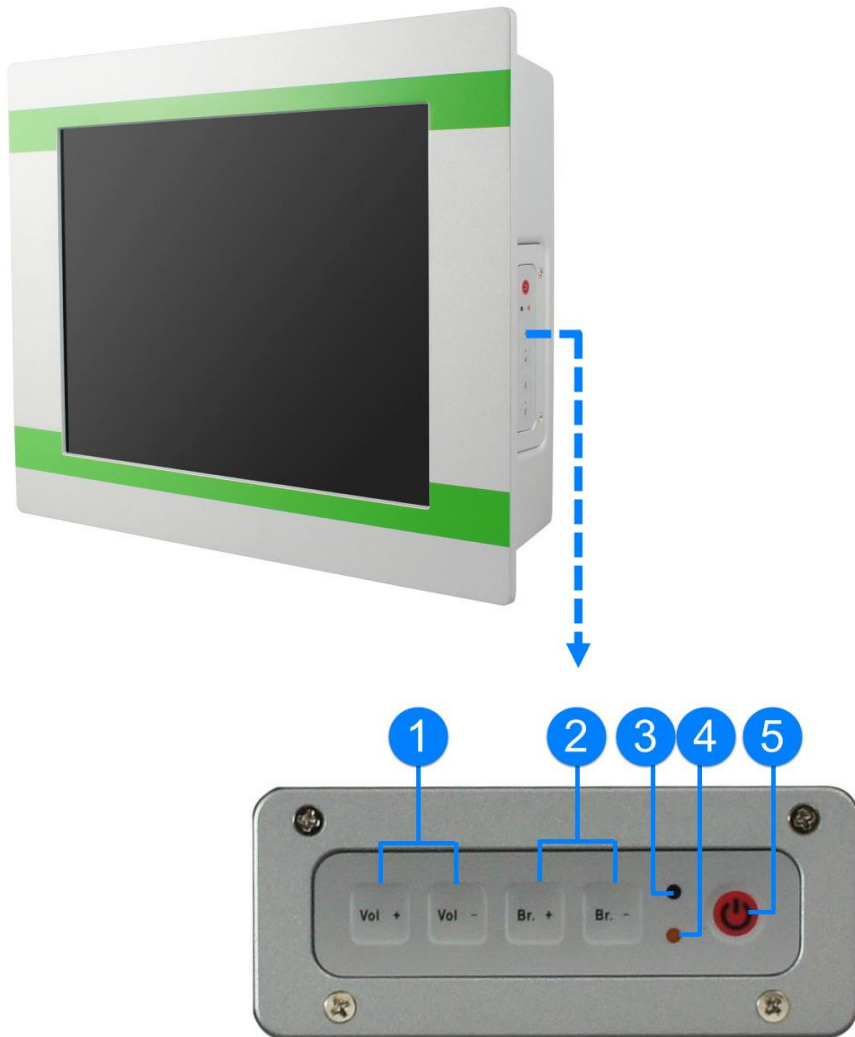

No.	Name	No.	Name
1	Volume Control	4	LED Indicator for Power
2	Brightness Control	5	Power Button
3	LED Indicator for HDD		

Rear View



No.	Name	No.	Name
1	Additional Rack Mount Kit	4	LAN Port (10/100)
2	Power Port	5	I/O Cover
3	USB 2.0 Port		

I/O View

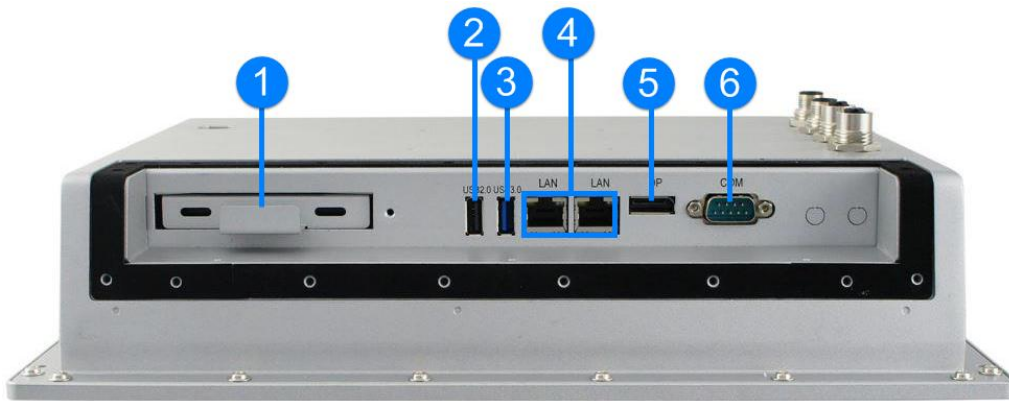

No.	Name	No.	Name
1	2.5" Drive Bay	4	LAN Port (GbE)
2	USB 2.0 Port	5	Display Port
3	USB 3.0 Port	6	COM Port

1.6 Dimensions

Unit: mm

Without Additional Rack Mount Kit

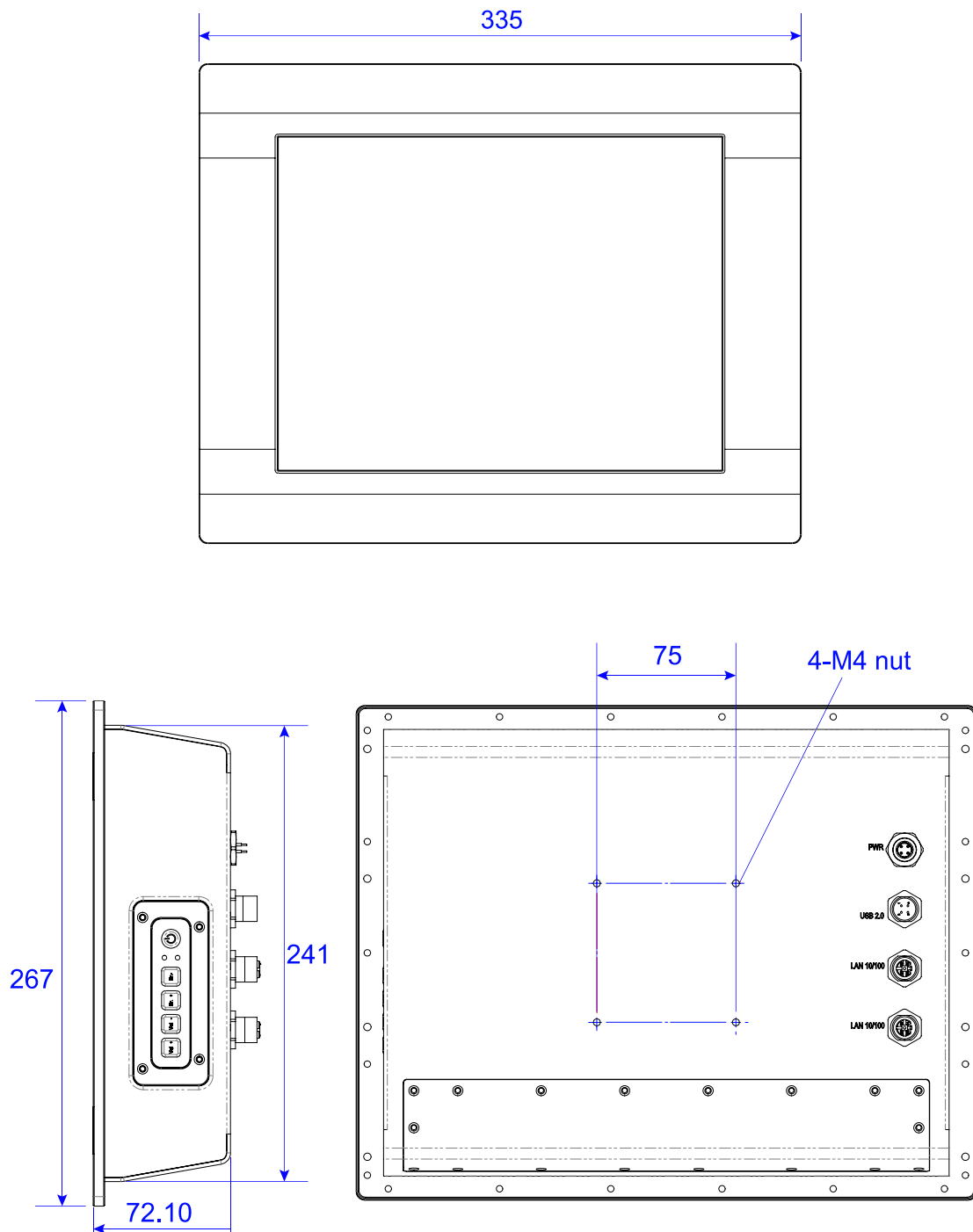

With Additional Rack-Mount Kit

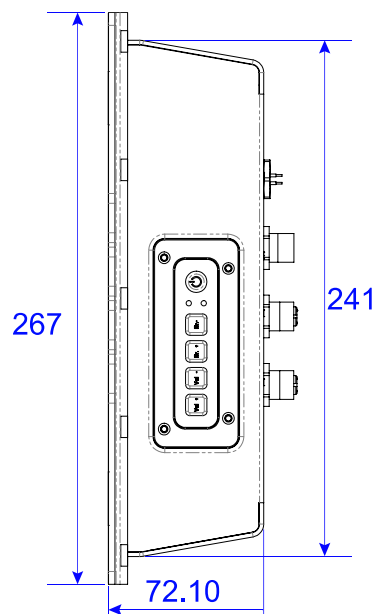
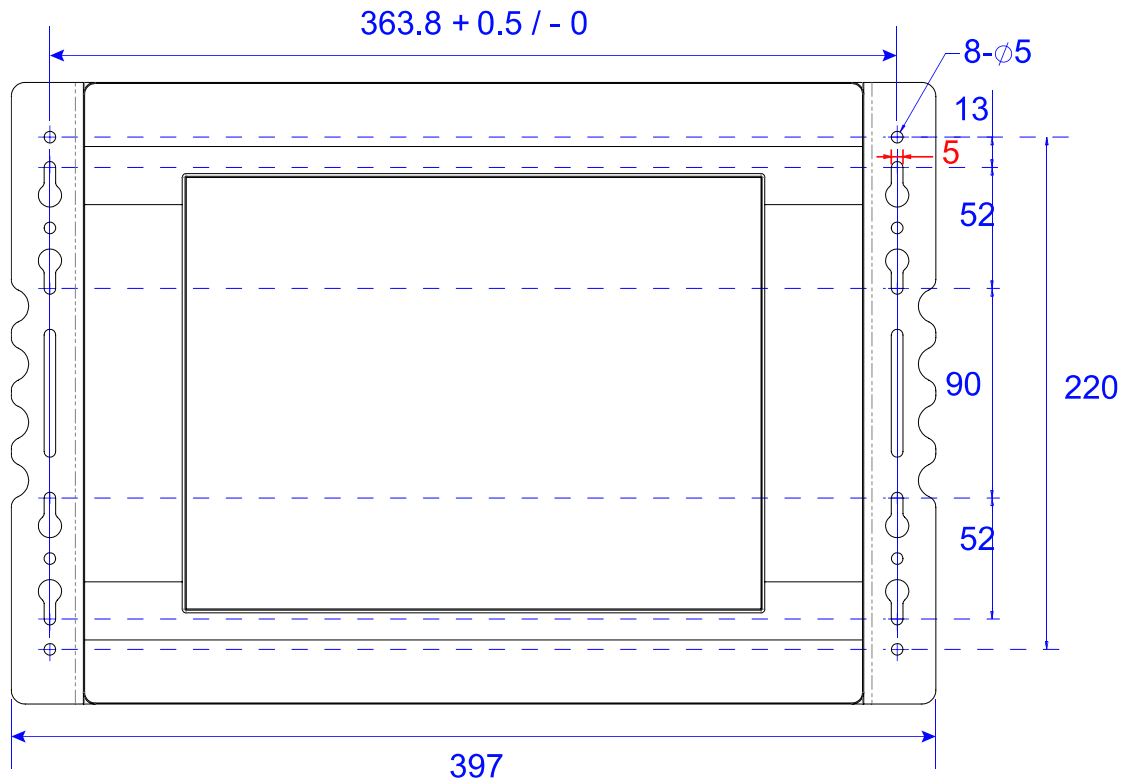

Chapter 2

Hardware Installation & Motherboard Information

The information provided in this chapter includes:

- Memory installation and membrane keypad extension
- Information and locations of connectors

2.1 Hardware Installation

Avoid Disassembly: You are not suggested to disassemble, repair or make any modification to the device. Disassembly, modification, or any attempt at repair could generate hazards and cause damage to the device, even bodily injury or property damage, and will void any warranty. If you need to make any change to the device, be sure to have qualified engineers or technicians for disassembly or installation.

2.1.1 Membrane Keypad Extension

You can extend the membrane keypad with the supplied extension cable. Follow the steps below to install the extension cable.

1. Release 4 screws of the membrane keypad and pull out the cable.



2. Separate the connected flat cables and secure the supplied keypad cover.



Keypad Cover

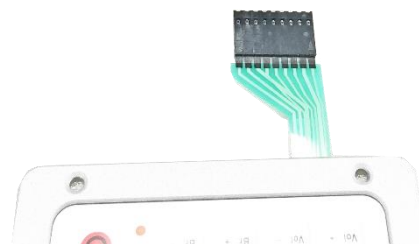

iBASE

3. Extend the keypad with the supplied extension cable.



- A. Connect the female end of the extension cable to the cable protruding from the device by aligning the pin 1 to pin 1 (white dots).



- B. Connect the male end of the extension cable to the membrane keypad by aligning the pin 1 to pin 1 (white dot on the extension cable to the arrow on the flat cable of the membrane keypad).

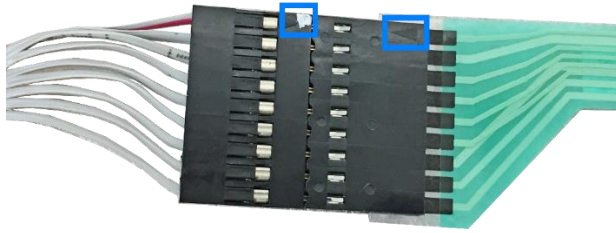

4. The membrane Keypad is now extended.



If you need to secure the extended keypad, you will need to prepare 4 screws (M3) yourself.

2.1.2 Memory Installation

There are two SO-DIMM DDR3L memory slots inside BYTEM-123-PC and the maximum memory supported is 8 GB.

The BYTEM-123-PC supports two SO- DIMM DDR3L memory slots for a maximum total memory of 8GB. To install the modules, locate the memory slot on the board and perform the following steps:

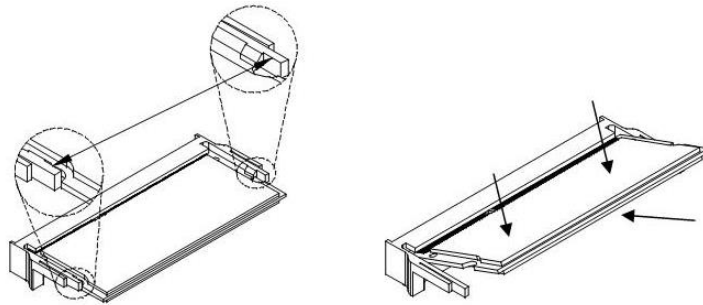

1. Align the key of the memory module with that on the memory slot and insert the module slantwise.
2. Gently push the module in an upright position until the clips of the slot close to hold the module in place when the module touches the bottom of the slot.

To remove the module, press the clips outwards with both hands.

2.1.3 VESA Mount & Wall Mount Installation

1. VESA Mount

You will need to prepare the VESA mount bracket in advance. Tighten 4 screws as below to attach the device to the bracket.

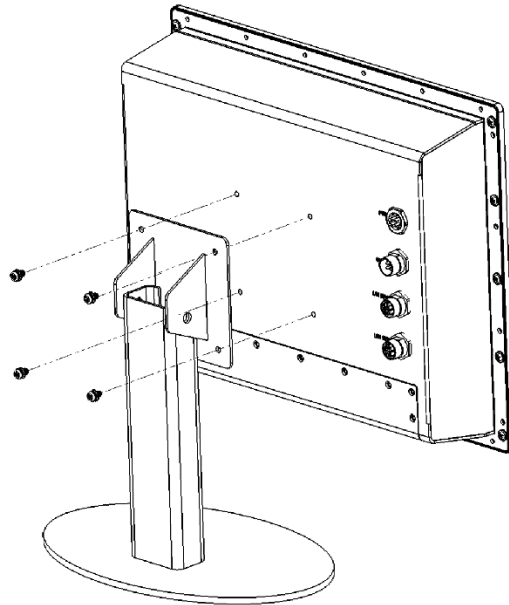

2. Wall Mount

Tighten the supplied M3 screws (8 pcs) to secure the Rack Mount Kit. Then install the device to wall with the supplied M4 screws (6 pcs).

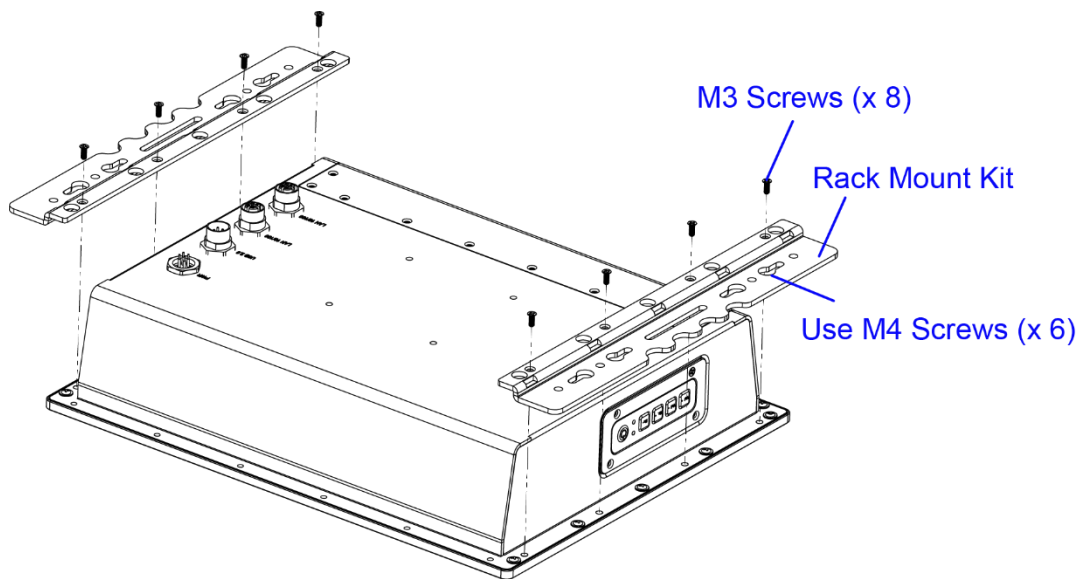

2.2 Setting the Jumpers

Set up and configure your BYTEM-123-PC by using jumpers for various settings and features according to your needs and applications. Contact your supplier if you have doubts about the best configuration for your use.

2.2.1 How to Set Jumpers

Jumpers are short-length conductors consisting of several metal pins with a non-conductive base mounted on the circuit board. Jumper caps are used to have the functions and features enabled or disabled. If a jumper has 3 pins, you can connect either PIN1 to PIN2 or PIN2 to PIN3 by shorting.

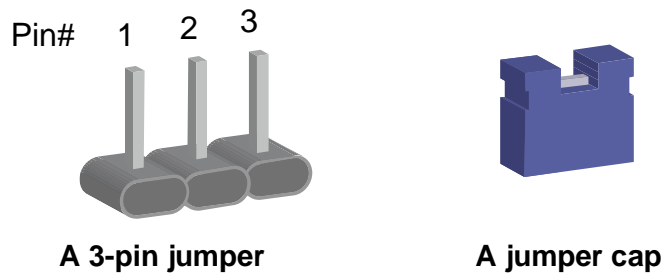

Refer to the illustration below to set jumpers.

Pin closed	Oblique view	Schematic illustration in the manual
Open		
1-2		
2-3		

When two pins of a jumper are encased in a jumper cap, this jumper is **closed**, i.e. turned **On**.

When a jumper cap is removed from two jumper pins, this jumper is **open**, i.e. turned **Off**.

2.3 Jumper & Connector Locations on Motherboard

Motherboard: IB897

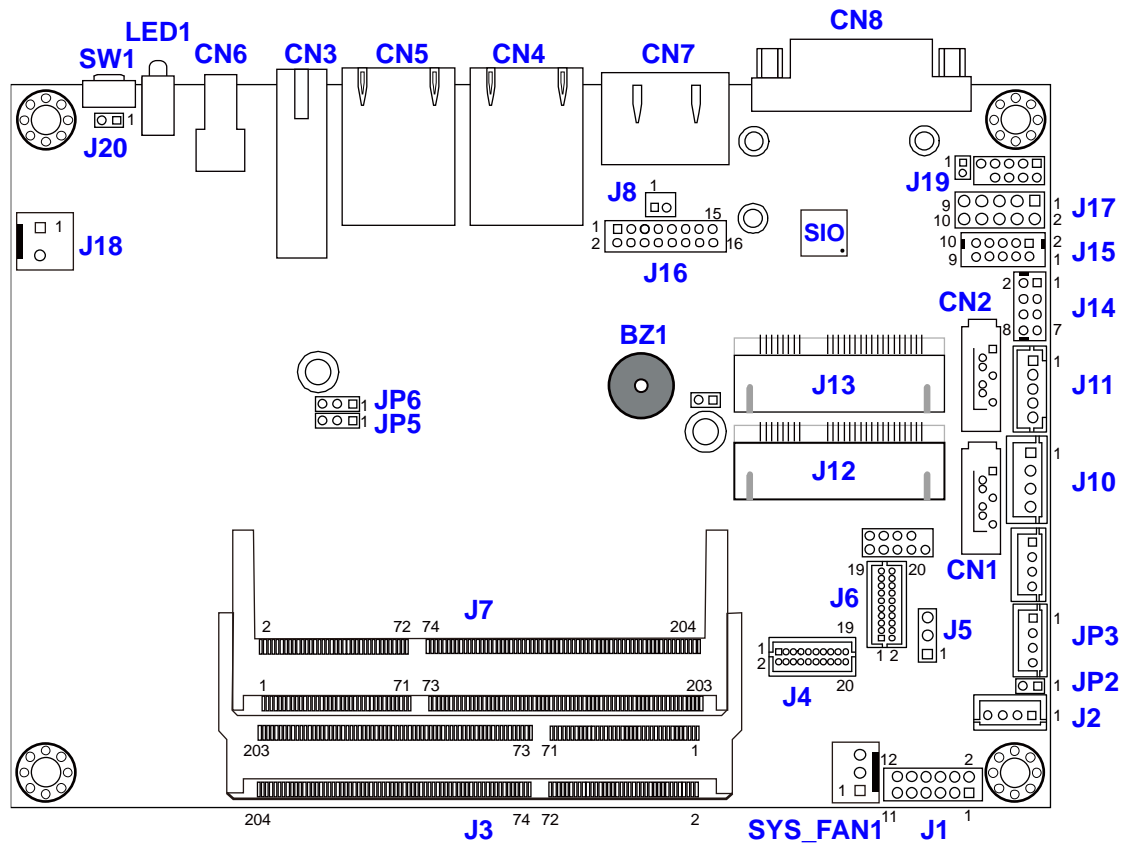

IB897 - top

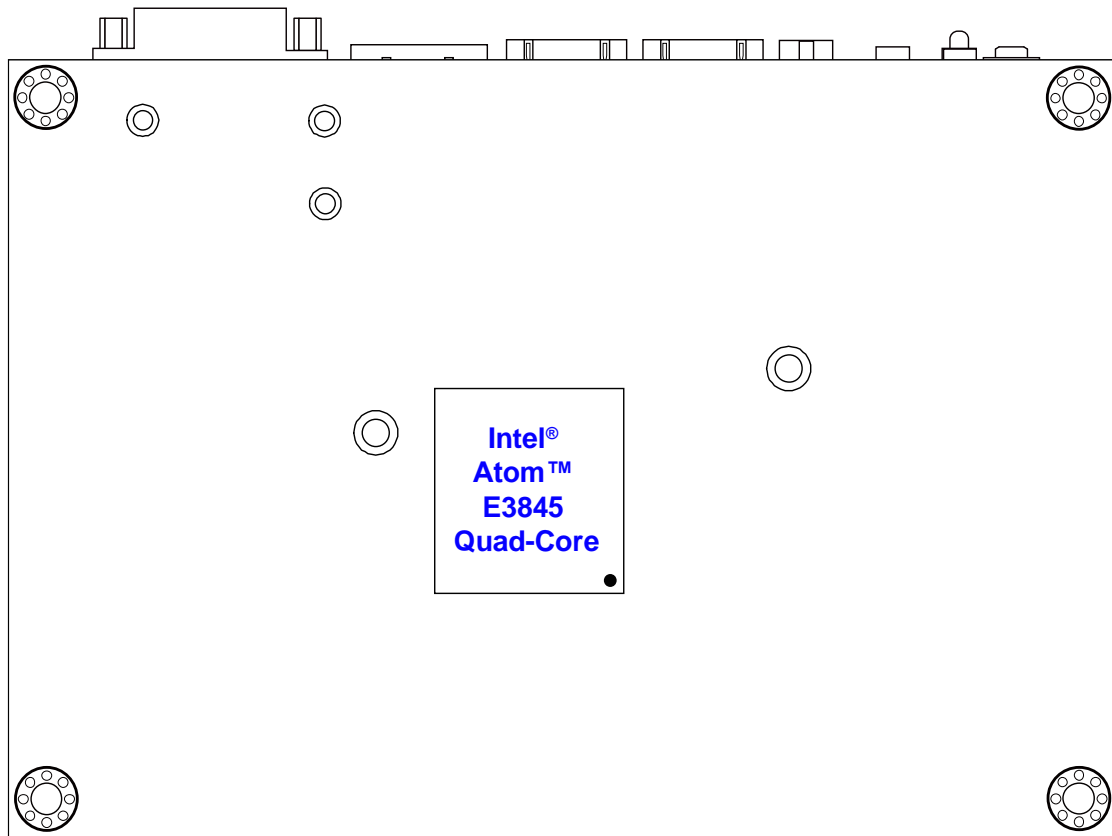

IB897 - bottom

2.4 Jumpers Quick Reference

Function	Connector Name	Page
LVDS Panel Power Selection	J5	19
LVDS Panel Brightness Control Selection	JP2	20
ME Register Clearance	JP5	20
CMOS Data Clearance	JP6	21

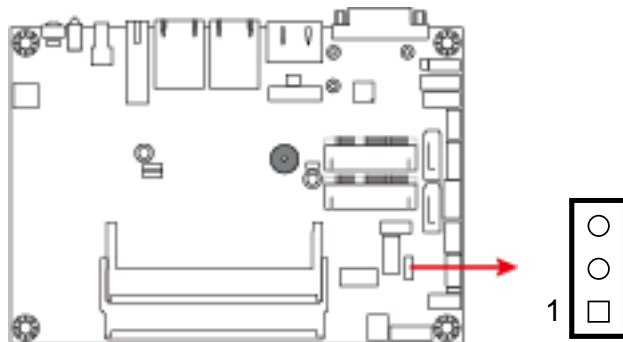

2.4.1 LVDS Panel Power Selection (J5)

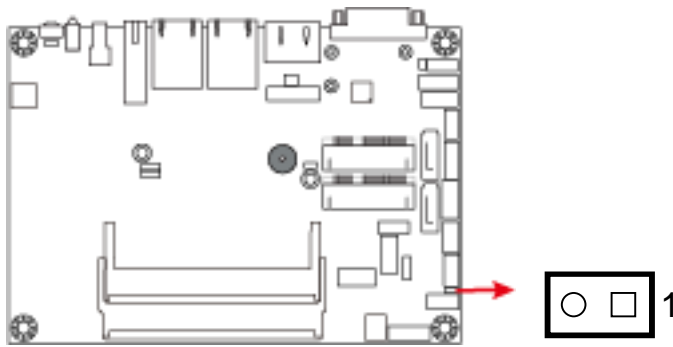

Function	Pin closed	Illustration
3.3V (default)	1-2	
5V	2-3	

2.4.2 LVDS Panel Brightness Control Selection (JP2)



Function	Pin closed	Illustration
3.3V	Open	 1
5V (default)	Close	 1

2.4.3 ME Register Clearance (JP5)

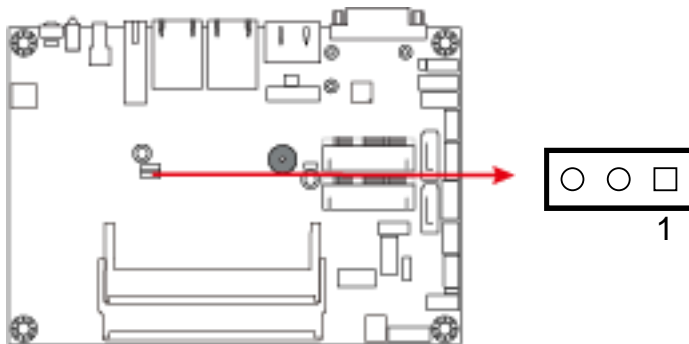

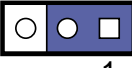
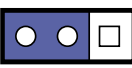
Function	Pin closed	Illustration
Normal (default)	1-2	 1
Clear ME Register	2-3	 1

2.4.4 CMOS Data Clearance (JP6)

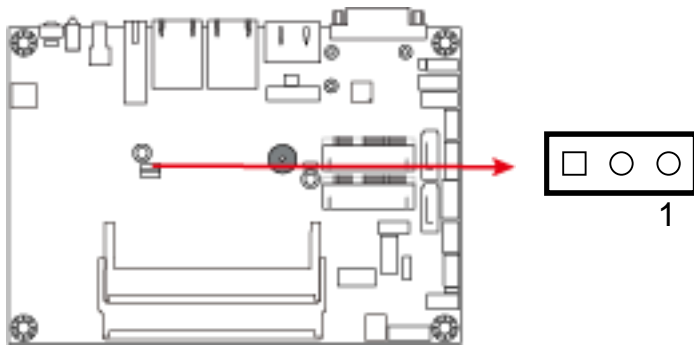

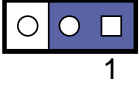
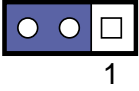
Function	Pin closed	Illustration
Normal (default)	1-2	
Clear CMOS	2-3	

2.5 Connectors Quick Reference

Function	Connector Name	Page
Motherboard Power Button	SW1	23
LED Indicators for Power and HDD	LED1	23
SATA II / mSATA Port	CN1	23
SATA II Port	CN2	24
USB 3.0 Port	CN3	24
LAN Port (GbE)	CN4, CN5	24
USB 2.0 Port	CN6	25
Display Port	CN7	25
COM1 Port	CN8	26
Audio Connector	J1	27
Amplifier Connector	J2	27
DDR3L SO-DIMM Socket	J3 (Channel B) J7 (Channel A)	28
LVDS Connector	J4, J6	28
SATA HDD Power Connector	J10	29
Smart Battery Connector	J11	29
Full-Sized Mini-PCIe / mSATA Connector	J12	30
Half-Sized Mini-PCIe Connector	J13	30
USB 2.0 Connector	J14	30
COM2 (RS-232) Port	J15	31
VGA Port	J16	31
Digital I/O Connector	J17	32
Motherboard Power Input Connector	J18	32
Reset Switch Connector	J19	33
Power Switch Connector	J20	33
LCD Backlight Connector	JP3	34
System Fan Power Connector	SYS_FAN1	34

2.5.1 Motherboard Power Button (SW1)

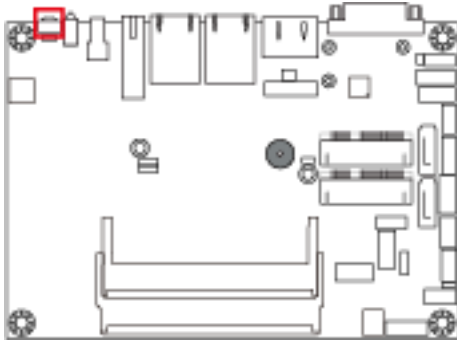

2.5.2 LED Indicators for Power and HDD (LED1)

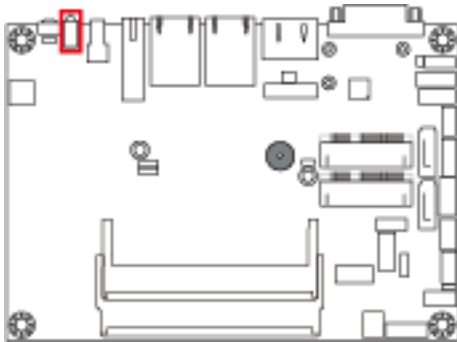

The green LED is Power LED.
The red LED is HDD LED.

2.5.3 SATA II / mSATA Port (CN1)

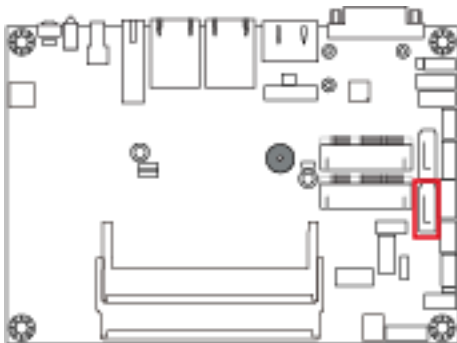

iBASE

2.5.4 SATA II Port (CN2)

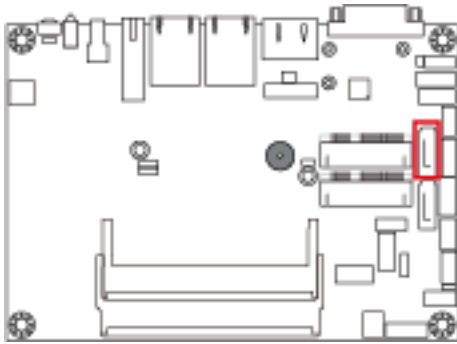

2.5.5 USB 3.0 Port (CN3)

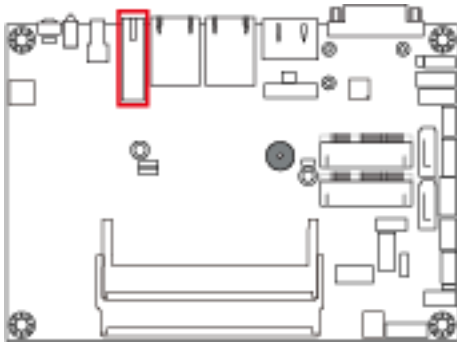

2.5.6 LAN Port (GbE) (CN4, CN5)

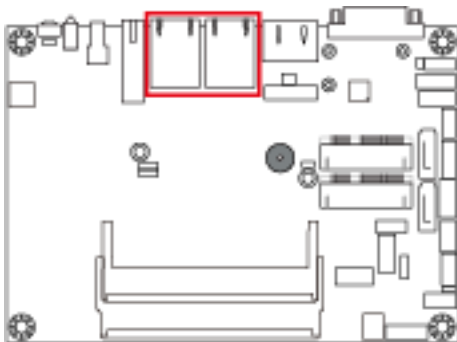

2.5.7 USB 2.0 Port (CN6)

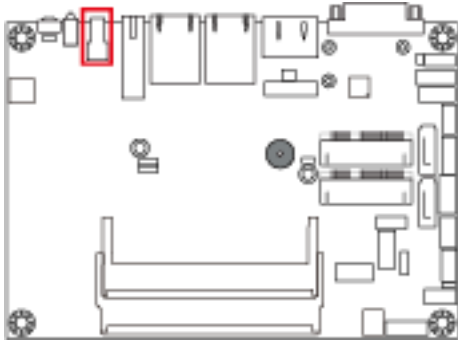

2.5.8 Display Port (CN7)

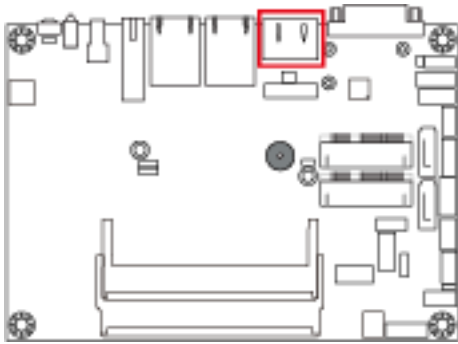

2.5.9 COM1 Port (RS-232/422/485) (CN8)

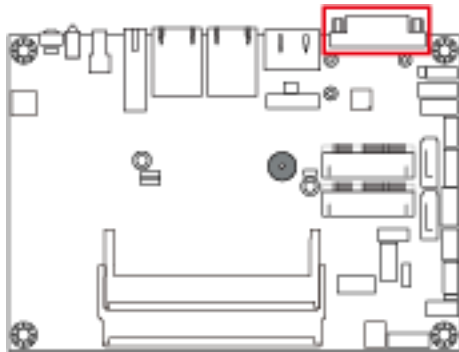

COM1 port is jumper-less and configurable on BIOS.

Pin	Assignment	Pin	Assignment
1	DCD, Data carrier detect	6	DSR, Data set ready
2	RXD, Receive data	7	RTS, Request to send
3	TXD, Transmit data	8	CTS, Clear to send
4	DTR, Data terminal ready	9	RI, Ring indicator
5	GND, ground		

Pin	Assignment		
	RS-232	RS-422	RS-485
1	DCD	TX-	DATA-
2	RX	TX+	DATA+
3	TX	RX+	NC
4	DTR	RX-	NC
5	Ground	Ground	Ground
6	DSR	NC	NC
7	RTS	NC	NC
8	CTS	NC	NC
9	RI	NC	NC

2.5.10 Audio Connector (J1)

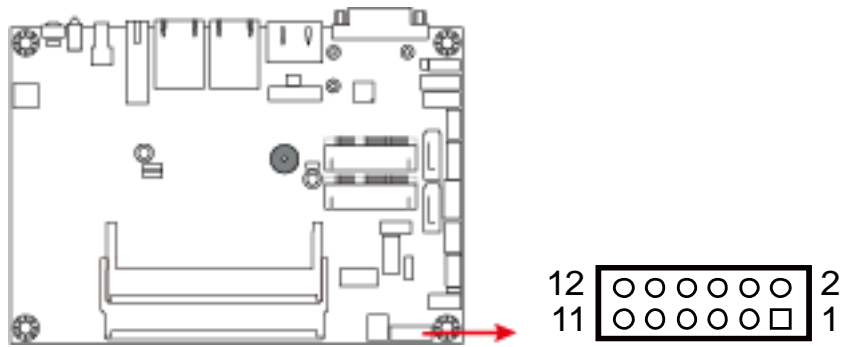

COM1 port is jumper-less and configurable on BIOS.

Pin	Assignment	Pin	Assignment
1	Lineout_L	7	JD_LINEIN
2	Lineout_R	8	Ground
3	JD_FRONT	9	MIC_L
4	Ground	10	MIC-R
5	LINEIN_L	11	JD_MIC1
6	Linein_R	12	Ground

2.5.11 Amplifier Connector (J2)

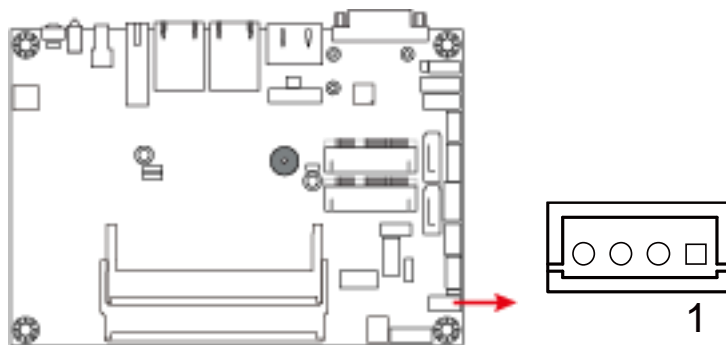

Pin	Assignment
1	OUTL+
2	OUTL-
3	OUTR-
4	OUTR+

2.5.12 DDR3L SO-DIMM Socket (J3, J7)

J7:
Channel A, must be installed to boot up the board.

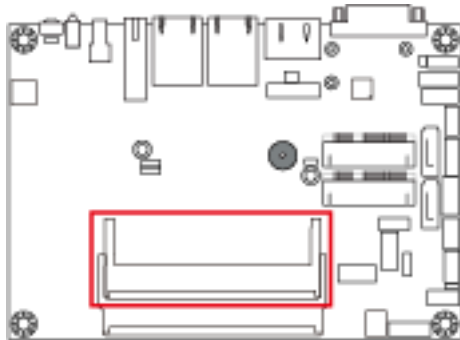

J3:
Channel B

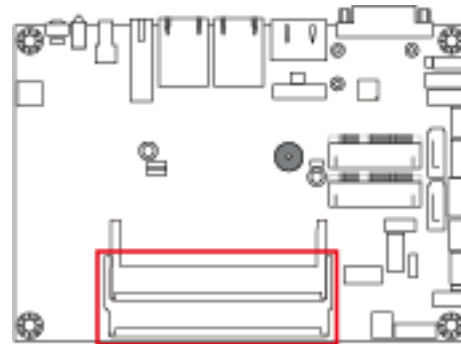

2.5.13 LVDS Connector (J4, J6)

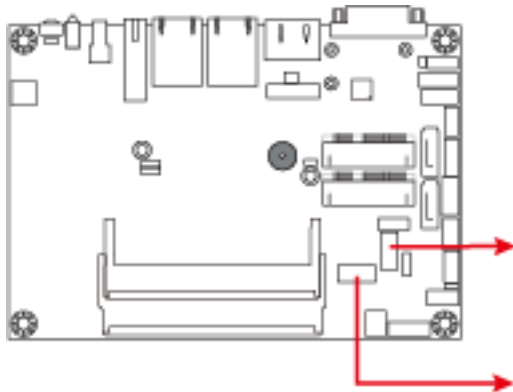

J6: Channel 1

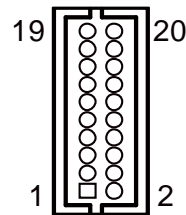

J4: Channel 2

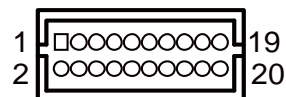

Pin	Assignment	Pin	Assignment
1	TX0P	11	Ground
2	TX0N	12	Ground
3	Ground	13	CLKP
4	Ground	14	CLKN
5	TX1P	15	Ground
6	TX1N	16	Ground
7	Ground	17	TX3P
8	Ground	18	TX3N
9	TX2P	19	Power
10	TX2N	20	Power(1A)

2.5.14 SATA HDD Power Connector (J10)

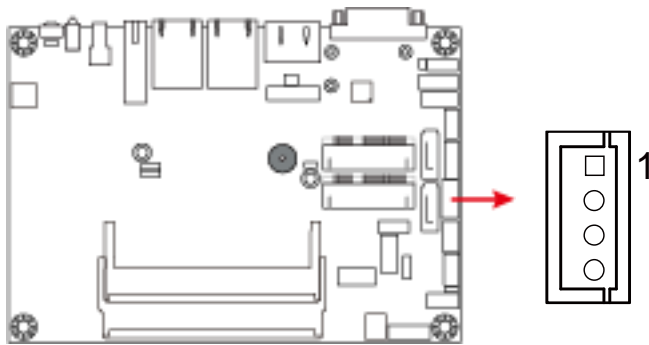

Pin	Assignment
1	+5V(1A)
2	Ground
3	Ground
4	+12V(1A)

2.5.15 Smart Battery Connector (J11)

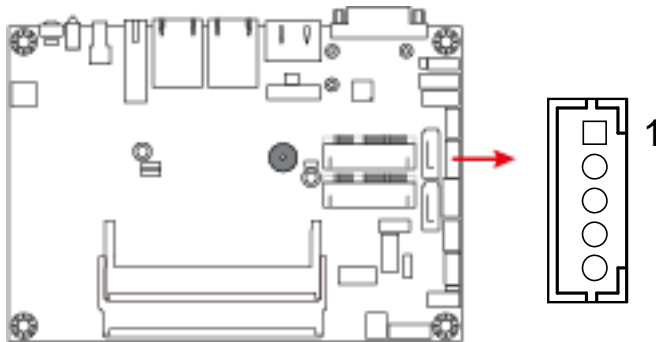

Pin	Assignment
1	RST#
2	ICHSWI#
3	Ground
4	SMB_DATA
5	SMB_CLK

2.5.16 Full-Sized Mini-PCle / mSATA Connector (J12)

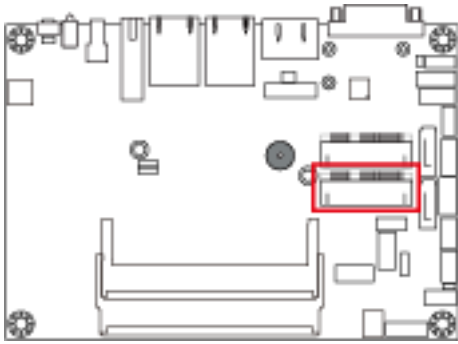

2.5.17 Half-Sized Mini-PCle Connector (J13)

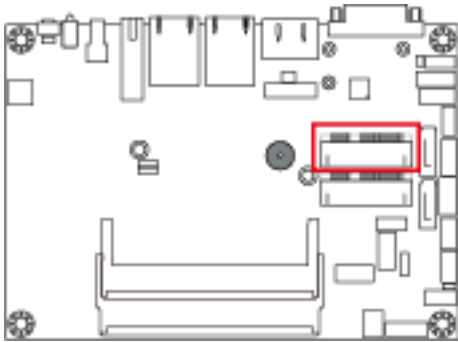

2.5.18 USB 2.0 Connector (J14)

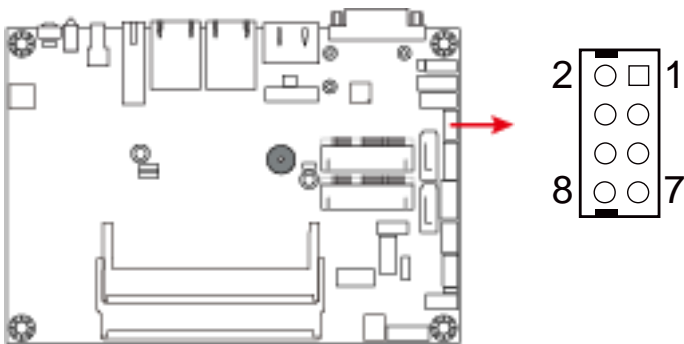

Pin	Assignment	Pin	Assignment
1	Vcc	5	D0+
2	Ground	6	D1-
3	D0-	7	Ground
4	D1+	8	Vcc

2.5.19 COM2 (RS-232) Port (J15)

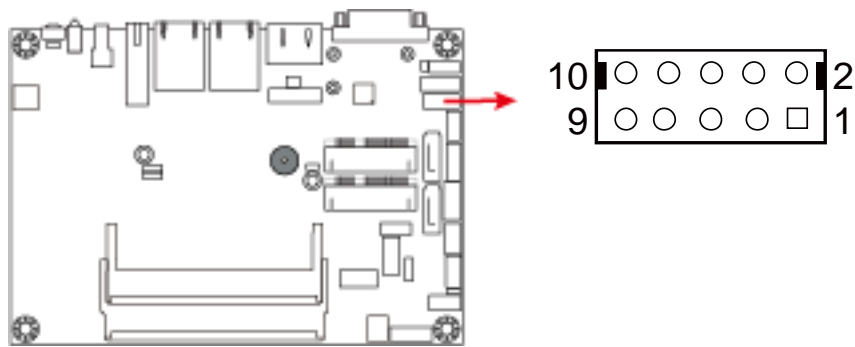

Pin	Assignment	Pin	Assignment
1	DCD, Data carrier detect	6	DSR, Data set ready
2	RXD, Receive data	7	RTS, Request to send
3	TXD, Transmit data	8	CTS, Clear to send
4	Data terminal ready	9	RI, Ring indicator
5	GND, ground	10	Not Used

2.5.20 VGA Port (J16)

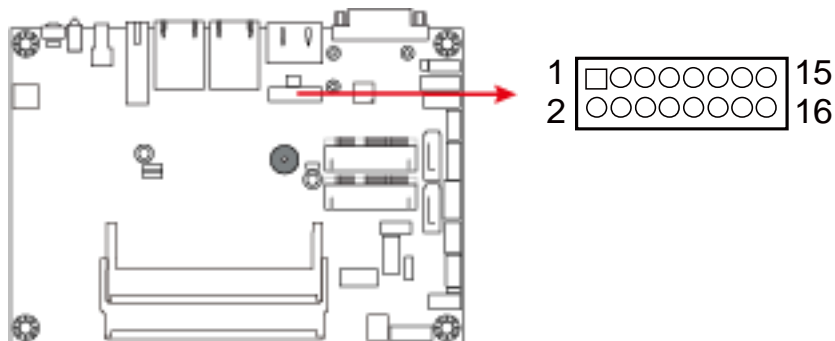

Pin	Assignment	Pin	Assignment
1	Red	9	GND
2	+5V	10	H_SYNC
3	Green	11	GND
4	Ground	12	V_SYNC
5	Blue	13	GND
6	N.C	14	DDCCLK
7	N.C	15	GND
8	DDCDATA	16	N.C.

2.5.21 Digital I/O Connector (J17)

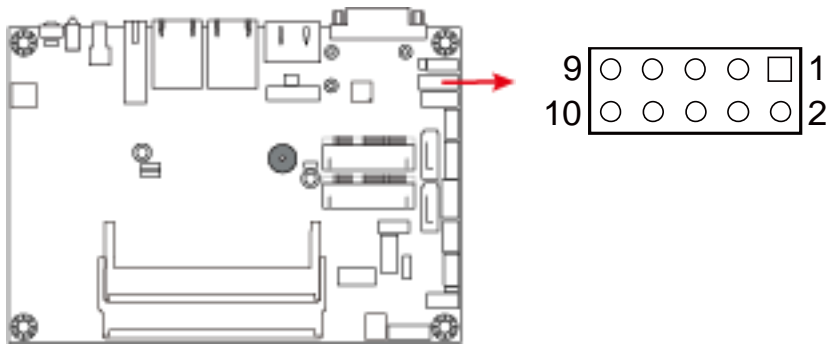

Pin	Assignment	Pin	Assignment
1	GND	6	OUT0
2	VCC(500mA)	7	IN3
3	OUT3	8	IN1
4	OUT1	9	IN2
5	OUT2	10	IN0

2.5.22 Motherboard Power Input Connector (J18)

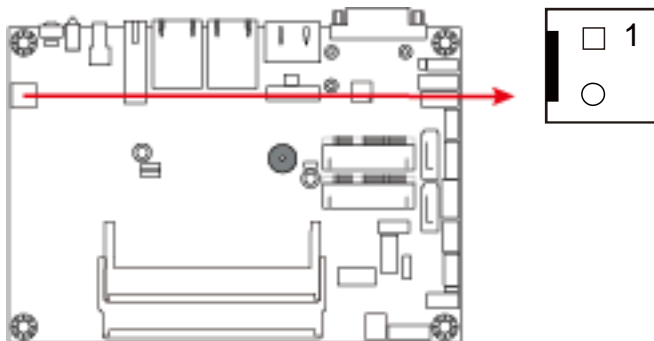

Pin	Assignment
1	+9V to +30V(10A)
2	GND

2.5.23 Reset Switch Connector (J19)

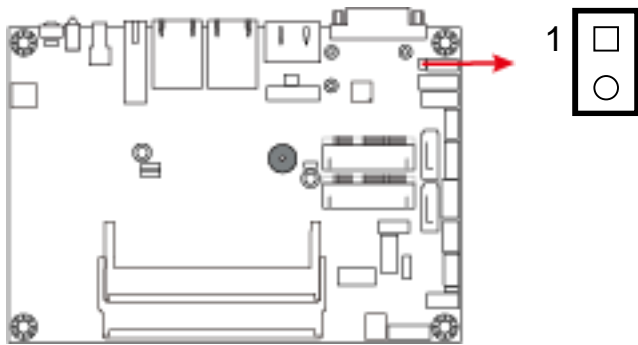

Pin	Assignment
1	Reset Switch
2	Ground

2.5.24 Power Switch Connector (J20)

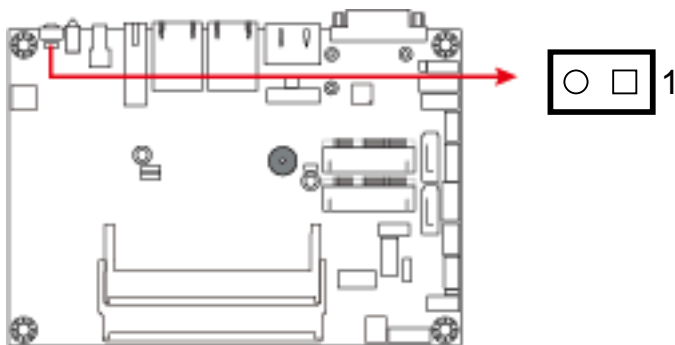

Pin	Assignment
1	Power Switch
2	Ground

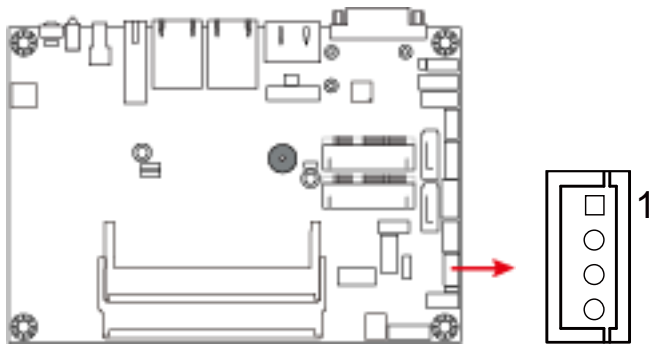
2.5.25 LCD Backlight Connector (JP3)

Pin	Assignment
1	+12V(1A)
2	Backlight Enable
3	Brightness Control
4	Ground

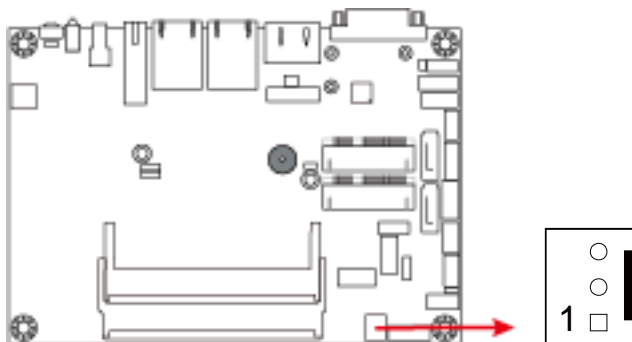
2.5.26 System Fan Power Connector (SYS_FAN1)

Pin	Assignment
1	Ground
2	+12V(500mA)
3	Rotation detection

Chapter 3

Driver Installation

The information provided in this chapter includes:

- Intel® Chipset Software Installation Utility
- VGA Driver Installation
- HD Audio Driver Installation
- Intel® Trusted Execution Engine Installation
- LAN Driver Installation

3.1 Introduction

This section describes the installation procedures for software drivers.

Note: After installing your Windows operating system, you must install the Intel® Chipset Software Installation Utility first before proceeding with the drivers installation.

3.2 Intel® Chipset Software Installation Utility

The Intel® Chipset drivers should be installed first before the software drivers to install INF files for Plug & Play function for the chipset components. Follow the instructions below to complete the installation.

1. Go to the download page of the product. Copy the compressed drivers file to your computer. Double click the file to decompress it. Run “CDGuide” to go to the main drivers page as shown. Click **Intel** and then **Intel(R) Baytrail Chipset Drivers**.



2. Click **Intel(R) Chipset Software Installation Utility**.



3. When the *Welcome* screen to the Intel® Chipset Device Software appears, click **Next** to continue.
4. Click **Yes** to accept the software license agreement and proceed with the installation process.
5. The driver has been completely installed. Click **Finish** to restart the computer and for changes to take effect.

3.3 VGA Driver Installation

1. Click **Intel** and then **Intel(R) Baytrail Chipset Drivers**.



2. Click **Intel(R) Baytrail Graphics Driver**.



3. When the *Welcome* screen appears, click **Next** to continue.
4. Click **Yes** to agree with the license agreement and continue the installation.
5. The driver has been completely installed. Click **Finish** to restart the computer and for changes to take effect.

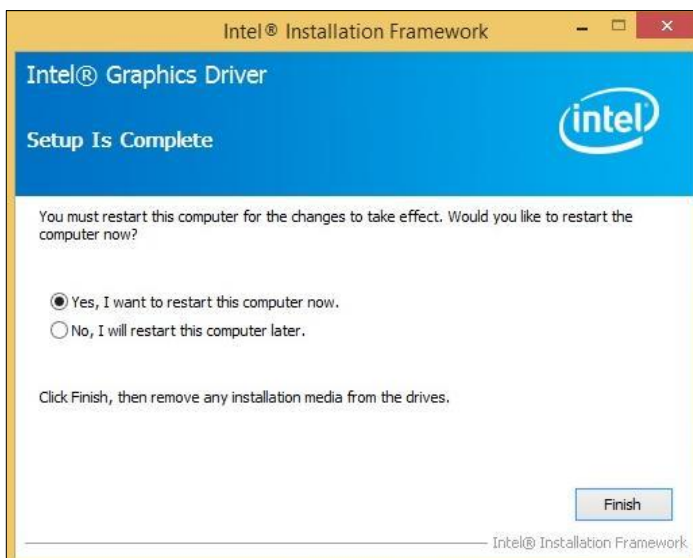

3.4 HD Audio Driver Installation

1. Click **Intel** and then **Intel(R) Baytrail Chipset Drivers**.



2. Click **Realtek High Definition Audio Driver**.



3. On the *Welcome* screen of the InstallShield Wizard, click **Next** for installation.

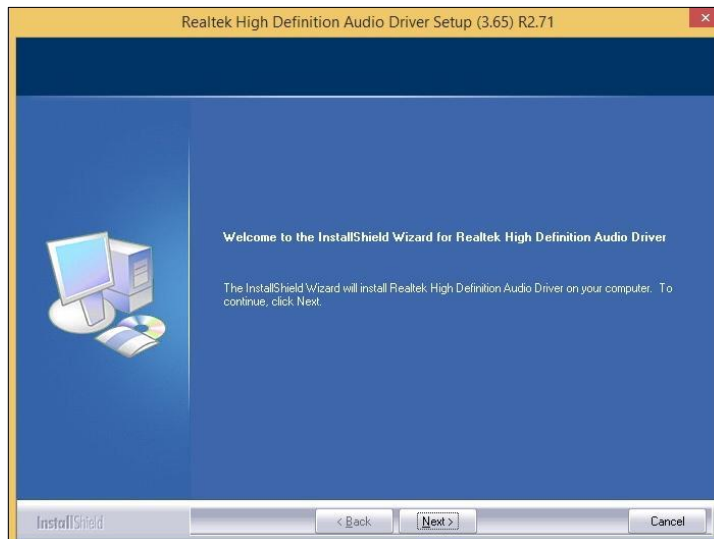

4. The driver has been completely installed. Click **Finish** to restart the computer and for changes to take effect.

3.5 Intel® Trusted Execution Engine Installation

Note: This driver is for Windows 7 only.

1. Click **Intel** and then **Intel(R) Baytrail Chipset Drivers**.



2. Click **Intel** and then **Intel(R) TXE Drivers**.



3. When the *Welcome* screen appears, click **Next** to continue installation.

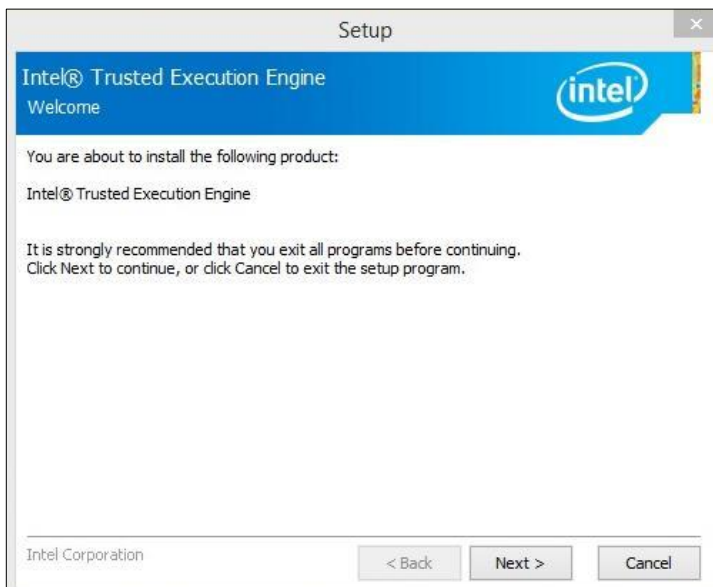

4. Click **Next** to agree with the license agreement and continue the installation.
5. The driver has been completely installed. Click **Finish**.

Chapter 4

BIOS Setup

This chapter describes the different settings available in the AMI BIOS that comes with the board. The topics covered in this chapter are as follows:

- Main Settings
- Advanced Settings
- Chipset Settings
- Security Settings
- Boot Settings
- Save & Exit

4.1 Introduction

The BIOS (Basic Input/Output System) installed in the ROM of your computer system supports Intel® processors. The BIOS provides critical low-level support for standard devices such as disk drives, serial ports and parallel ports. It also provides password protection as well as special support for detailed fine-tuning of the chipset controlling the entire system.

4.2 BIOS Setup

The BIOS provides a Setup utility program for specifying the system configurations and settings. The BIOS ROM of the system stores the Setup utility. When you turn on the computer, the BIOS is immediately activated. Press the key immediately allows you to enter the Setup utility. If you are a little bit late pressing the key, POST (Power On Self Test) will continue with its test routines, thus preventing you from invoking the Setup.

If you still need to enter Setup, restart the system by pressing the "Reset" button or simultaneously pressing the <Ctrl>, <Alt> and <Delete> keys. You can also restart by turning the system Off and back On again.

The following message will appear on the screen:

```
Press <DEL> to Enter Setup
```

In general, press the arrow keys to highlight items, <Enter> to select, the <PgUp> and <PgDn> keys to change entries, <F1> for help, and <Esc> to quit.

When you enter the BIOS Setup utility, the *Main Menu* screen will appear on the screen. The Main Menu allows you to select from various setup functions and exit choices.

Warning: It is strongly recommended that you avoid making any changes to the chipset defaults.

These defaults have been carefully chosen by both AMI and your system manufacturer to provide the absolute maximum performance and reliability. Changing the defaults could make the system unstable and crash in some cases.

4.3 Main Settings

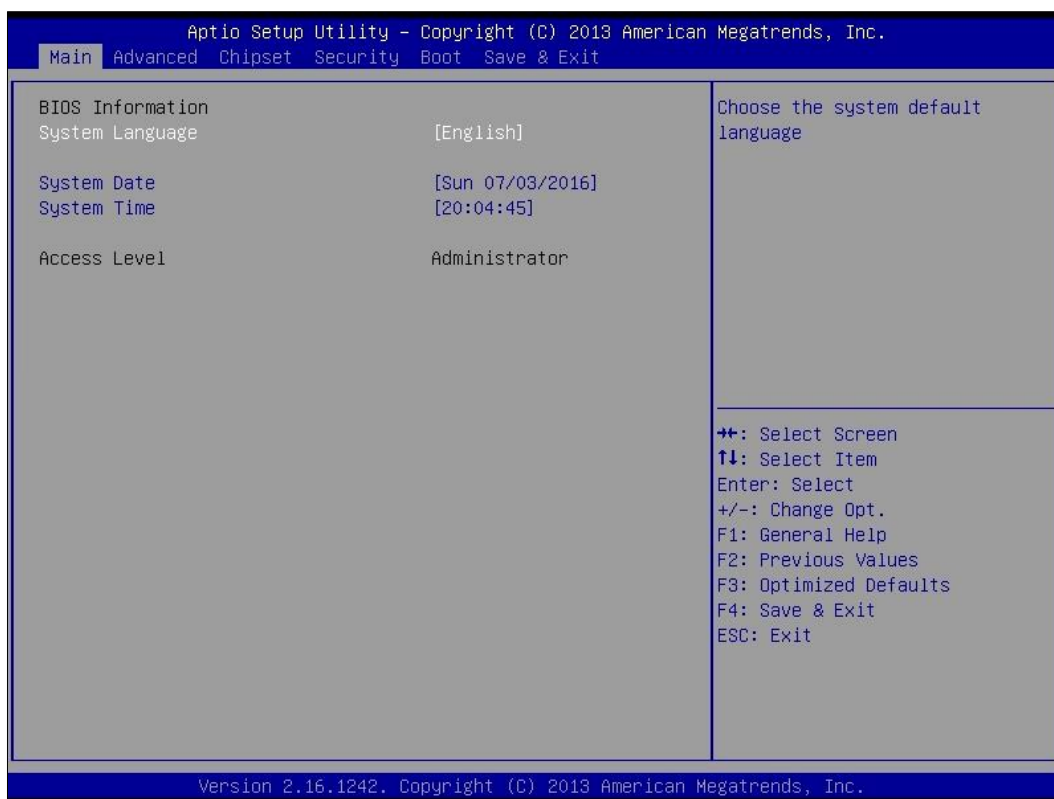

BIOS Setting	Description
System Language	Choose the system default language
System Date	Sets the date. Use the <Tab> key to switch between the date elements.
System Time	Set the time. Use the <Tab> key to switch between the time elements.

4.4 Advanced Settings

This section allows you to configure, improve your system and allows you to set up some system features according to your preference.

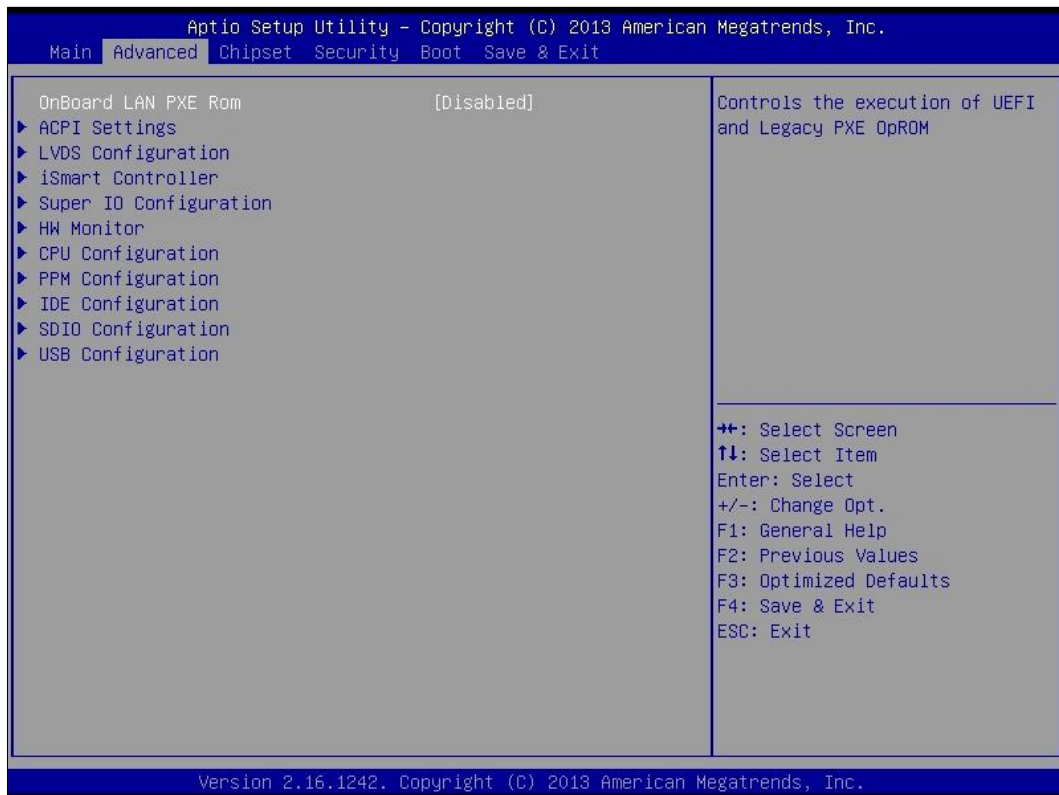

4.4.1 ACPI Settings

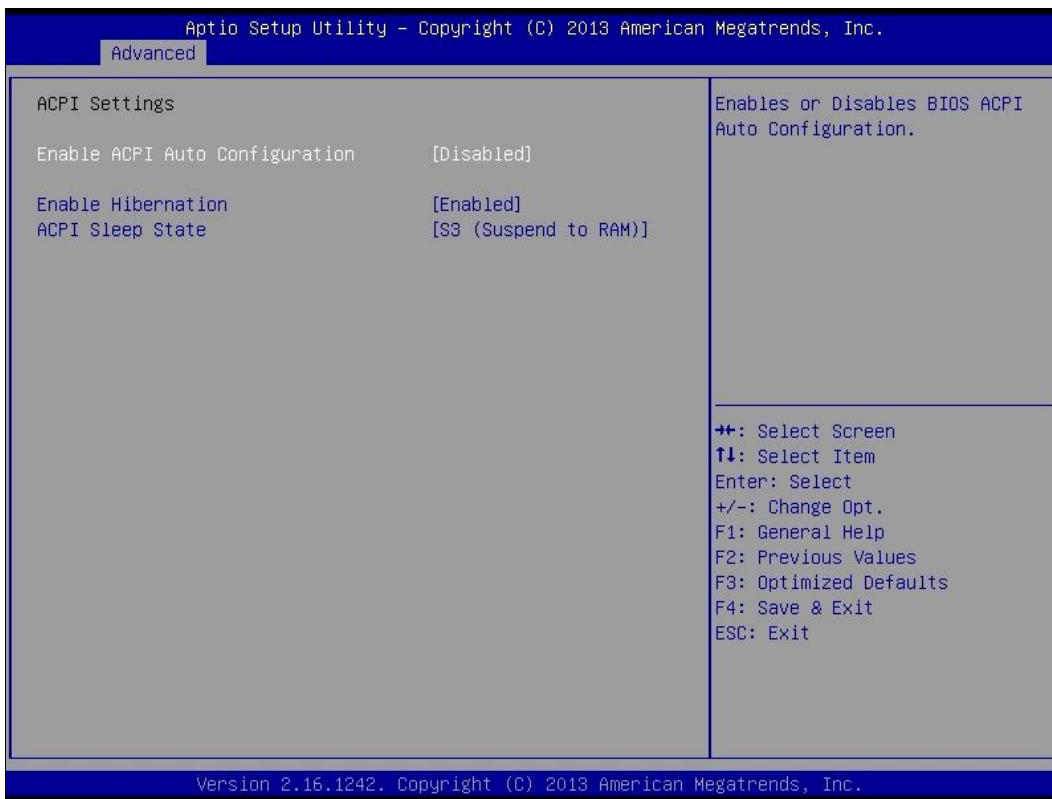

BIOS Setting	Description
Enabled ACPI Auto Configuration	Enables or disables BIOS ACPI Auto Configuration.
Enable Hibernation	Enables or disables the System ability to Hibernate (OS/S4 Sleep State). This option may not be effective with some OS.
ACPI Sleep State	Selects ACPI sleep state that the system will enter when the suspend button is pressed.

4.4.2 LVDS Configuration

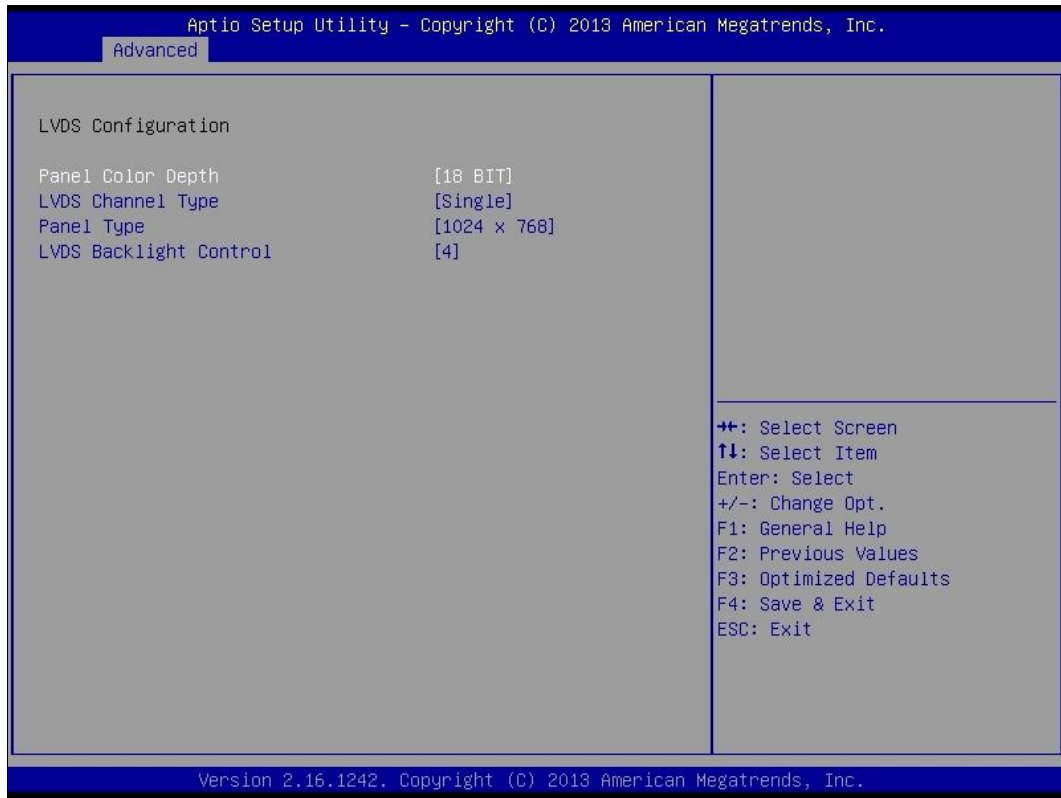

BIOS Setting	Description
Digital GPIO 1 ~ 6	Configure Digital GPIO as input or output.

4.4.3 iSMART Controller

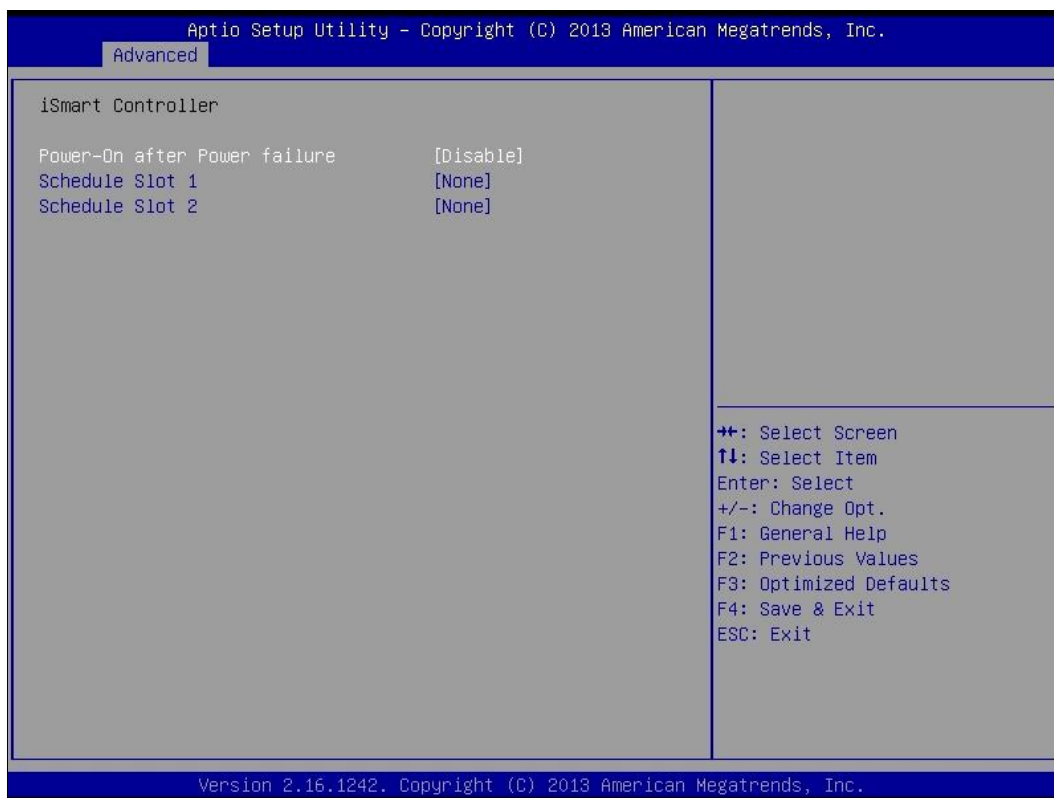

BIOS Setting	Description
Power-On after Power failure	Enables / Disables the system to be turned on automatically after a power failure.
Schedule Slot 1 / 2	Sets up the hour / minute for system powe-on.

4.4.4 Super IO Configuration

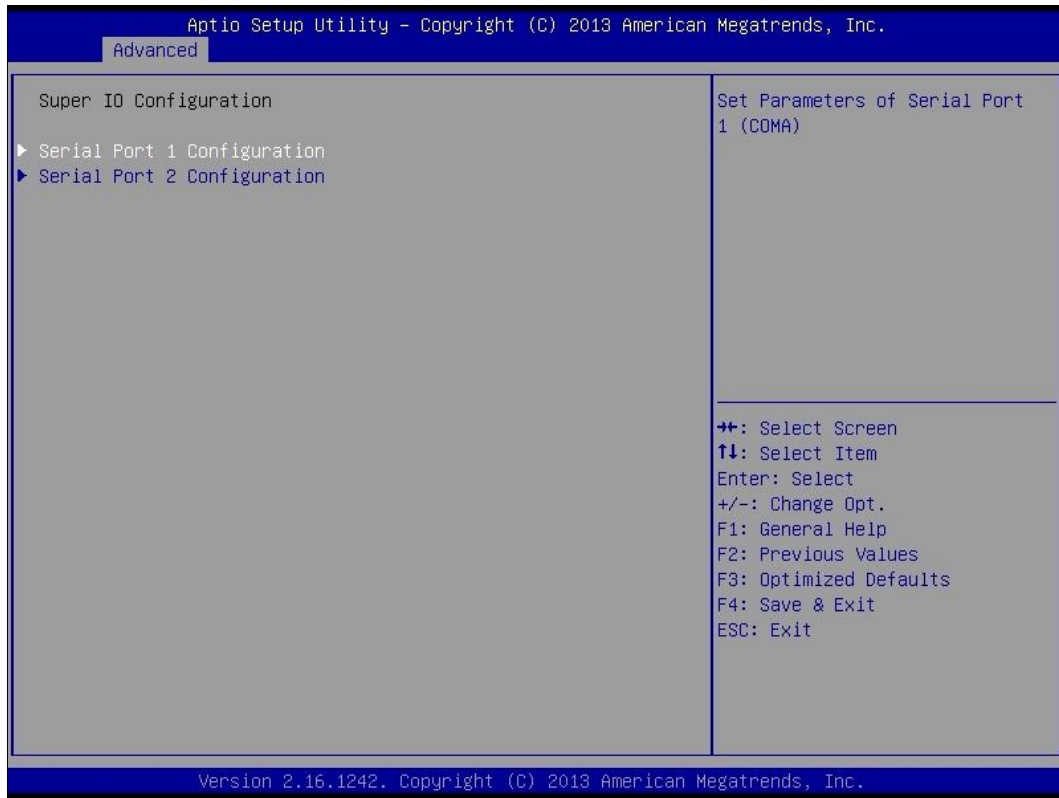

BIOS Setting	Description
Serial Port 1 Configuration	Sets parameters of serial port 1 (COMA).
Serial Port 2 Configuration	Sets parameters of serial port 2 (COMA).

4.4.5 Hardware Monitor

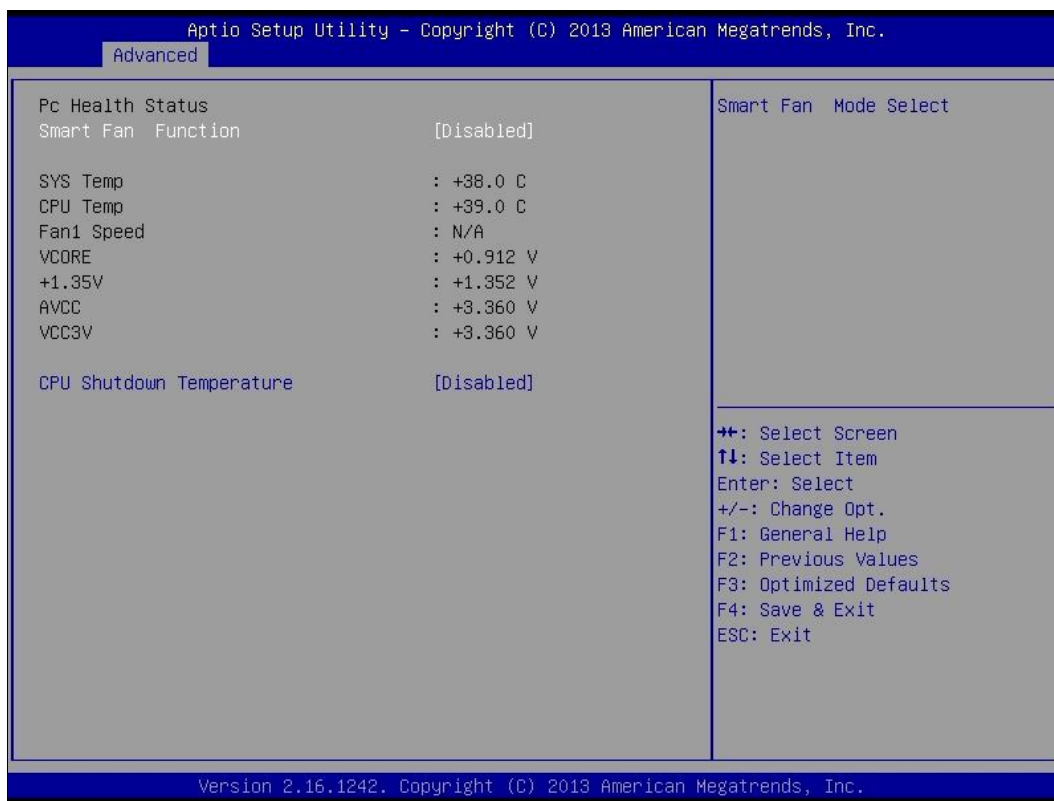

BIOS Setting	Description
Smart Fan Function	This field enables or disables the smart fan feature. Options: Disabled (default), 50 °C, 60 °C, 70 °C, 80 °C, 90 °C
Shutdown Temperature	This field enables or disables the Shutdown Temperature Options: Disabled (default). 70 °C, 75 °C, 80 °C, 85 °C, 90 °C, 95 °C
Temperatures / Voltages	These fields are the parameters of the hardware monitoring function feature of the motherboard. The values are read-only values as monitored by the system and show the PC health status

4.4.6 CPU Configuration

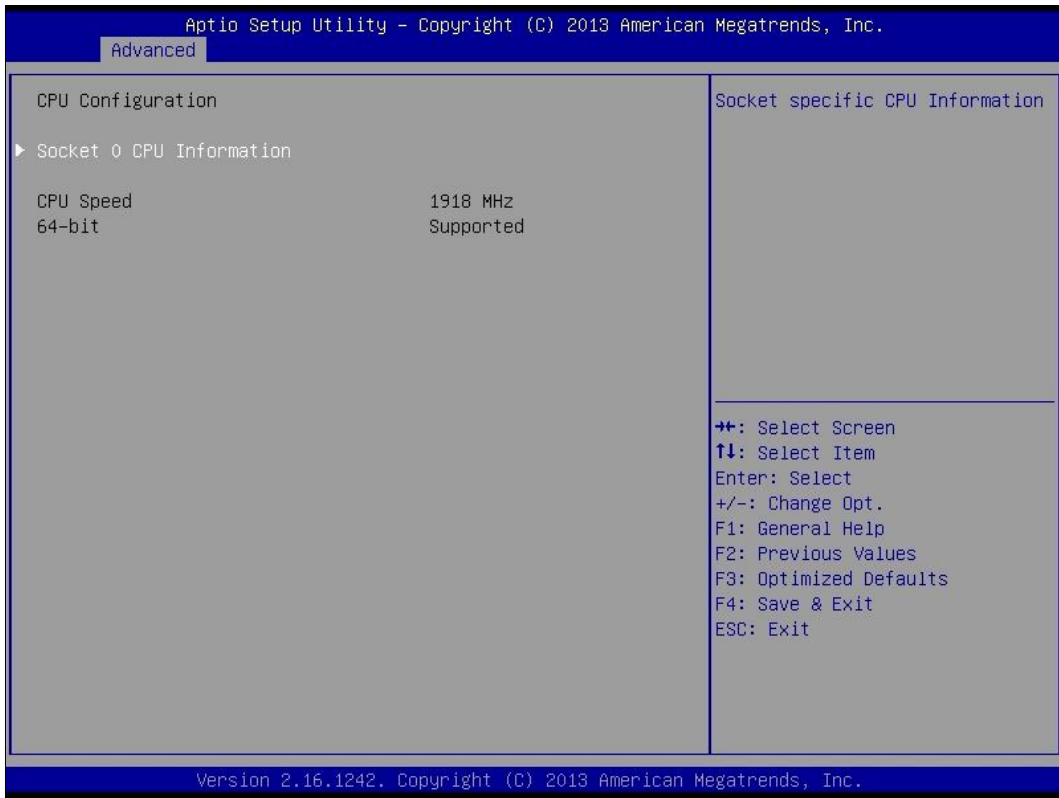

BIOS Setting	Description
Socket 0 CPU Information	Displays the specific socket CPU Information.

4.4.7 CPU PPM Configuration

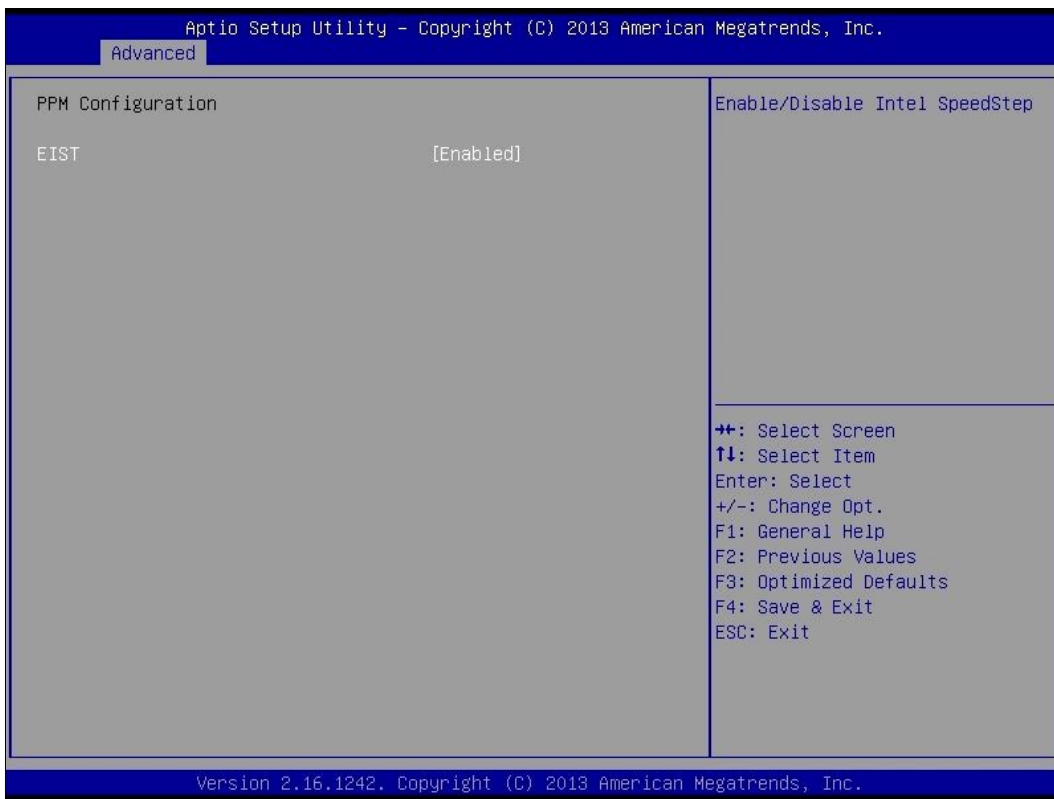

BIOS Setting	Description
EIST	Enables or disables Intel SpeedStep.

4.4.8 IDE Configuration

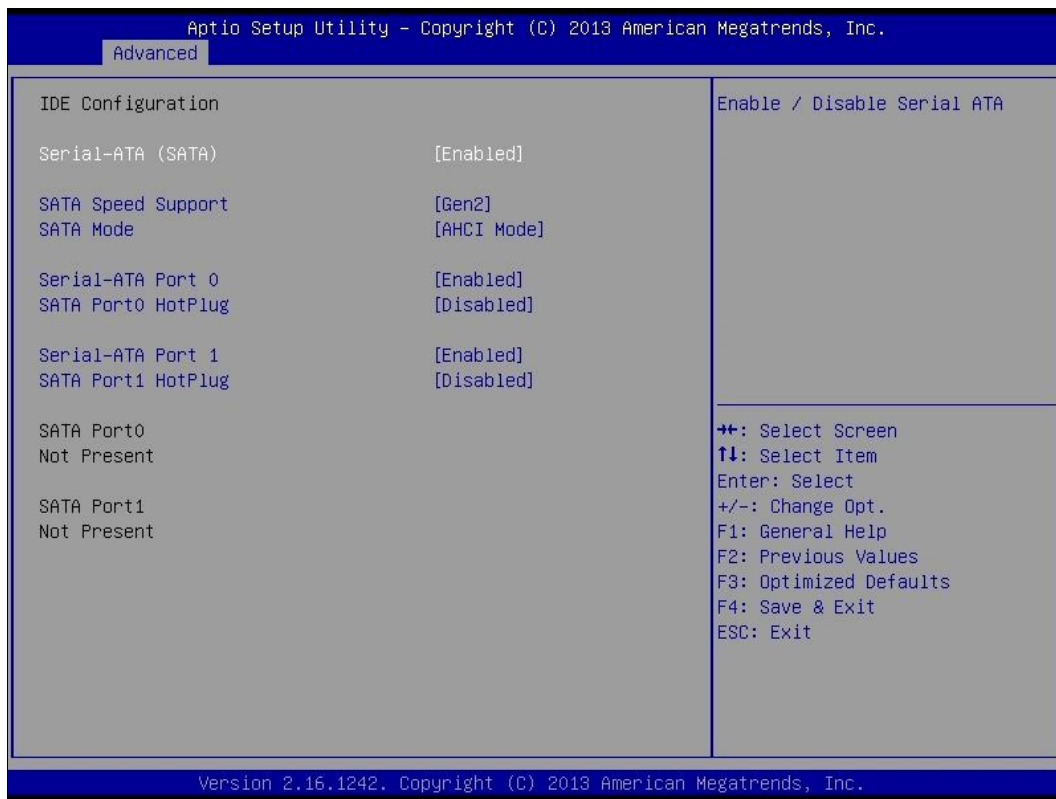

BIOS Setting	Description
Serial-ATA (SATA)	Enables / Disables the Serial ATA.
SATA Mode	Selects IDE / AHCI Mode.
Serial –ATA Port 0	Enables / Disables Serial Port 0.
SATA Port0 HotPlug	Enables / Disables SATA Port 0 HotPlug.
Serial –ATA Port 1	Enables / Disables Serial Port 1.
SATA Port1 HotPlug	Enables / Disables SATA Port 1 HotPlug.

4.4.9 SDIO Configuration

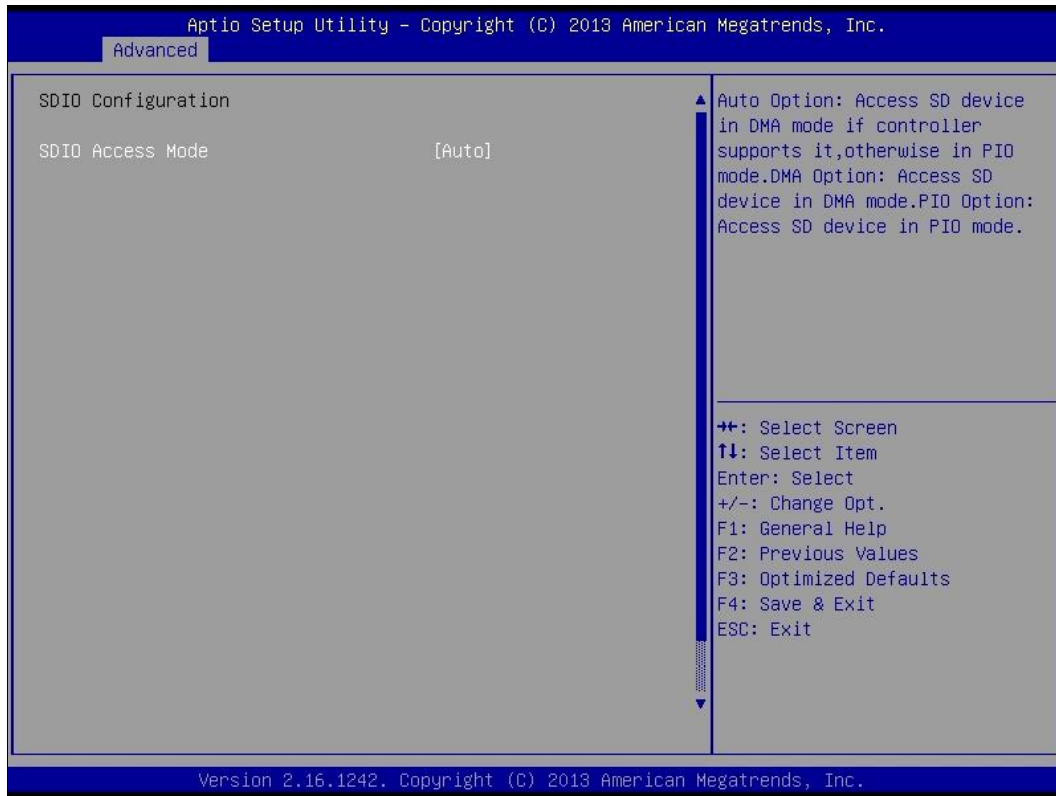

BIOS Setting	Description
SDIO Access Mode	<ul style="list-style-type: none"> • Auto: Access an SD device in DMA mode if controller supports it. Otherwise, in PIO mode. • DMA: Access an SD device in DMA mode. • PIO: Access an SD device in PIO mode.

4.4.10 USB Configuration

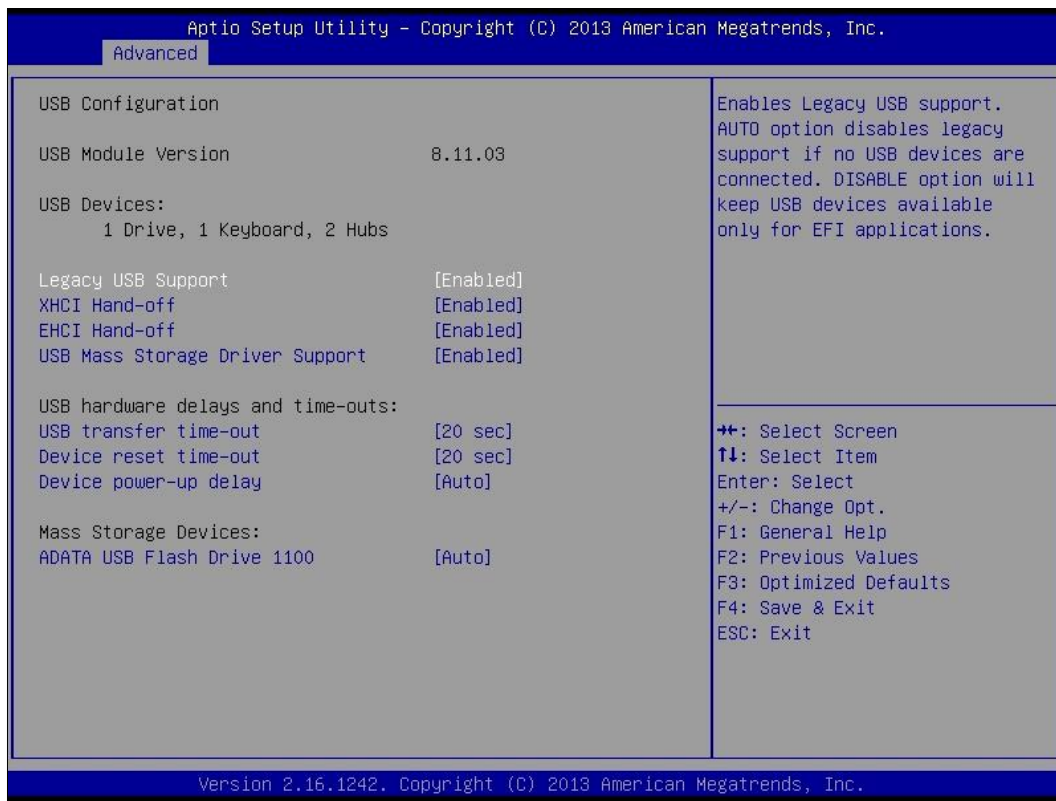

BIOS Setting	Description
Legacy USB Support	<ul style="list-style-type: none"> • Enable: Enables Legacy USB Support. • Auto: Disables legacy support if no USB devices are connected. • Disable: Keeps USB devices available only for EFI applications.

4.5 Chipset Settings

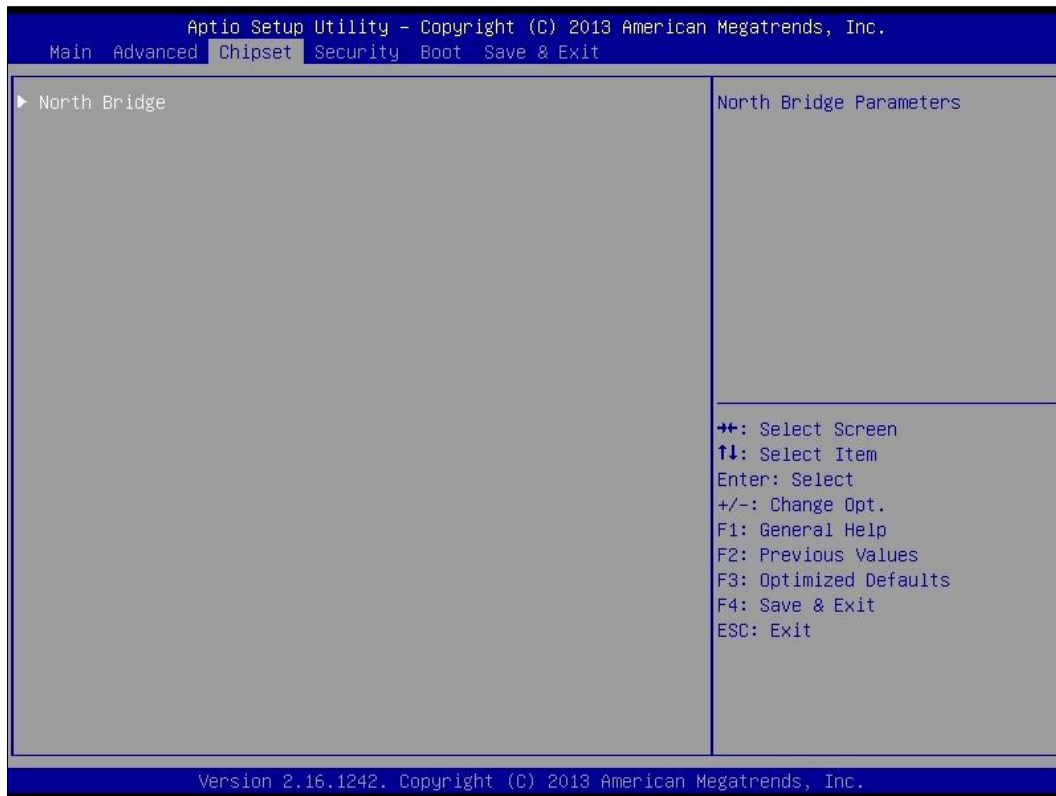

4.5.1 North Bridge

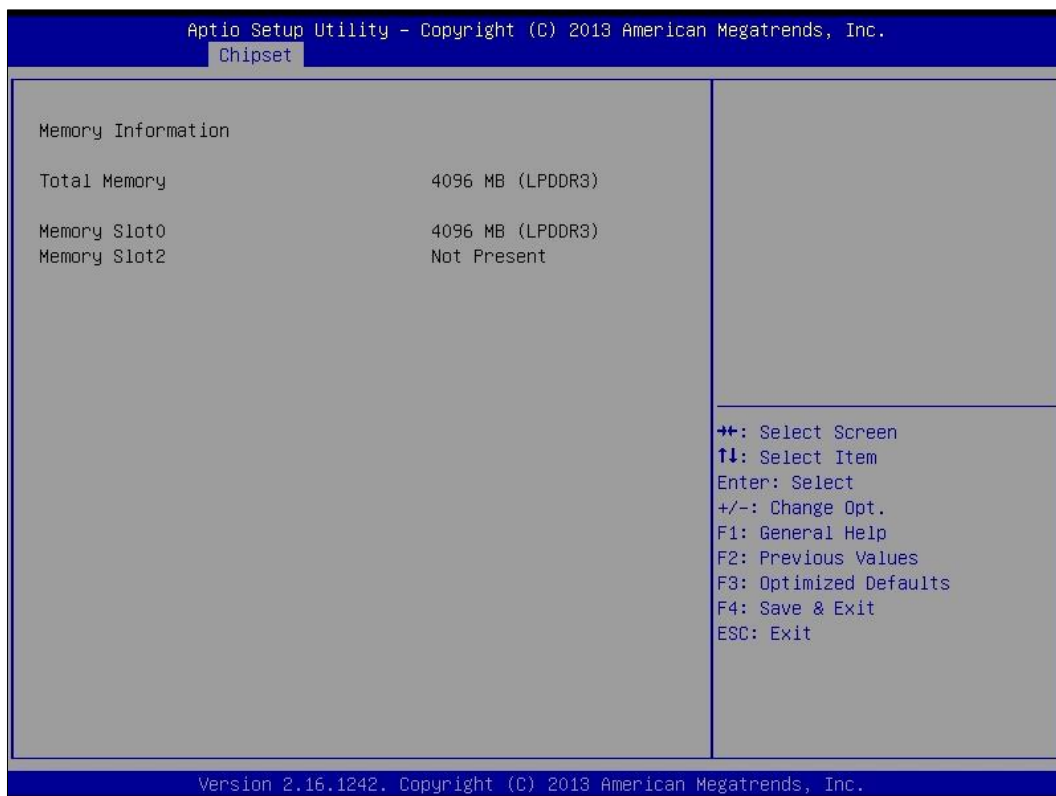

4.6 Security Settings

This section allows you to configure, improve your system, and set up some system features according to your preference.

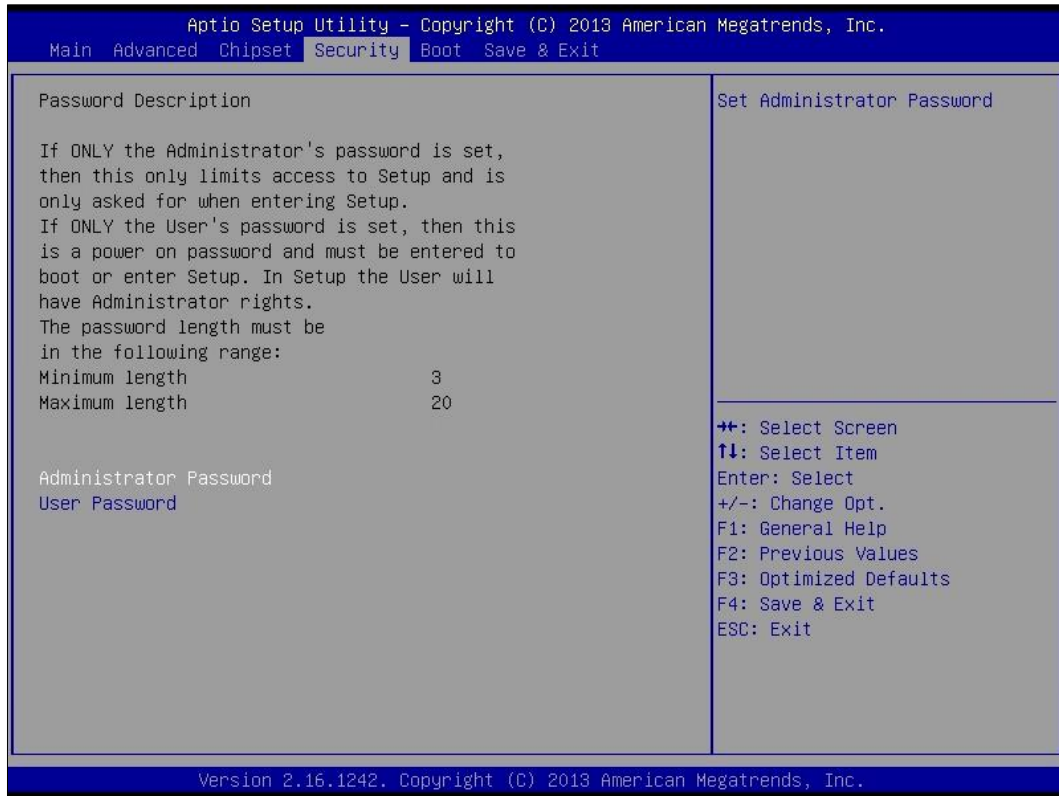

BIOS Setting	Description
Administrator Password	Sets an administrator password for the setup utility.
User Password	Sets a user password.

4.7 Boot Settings

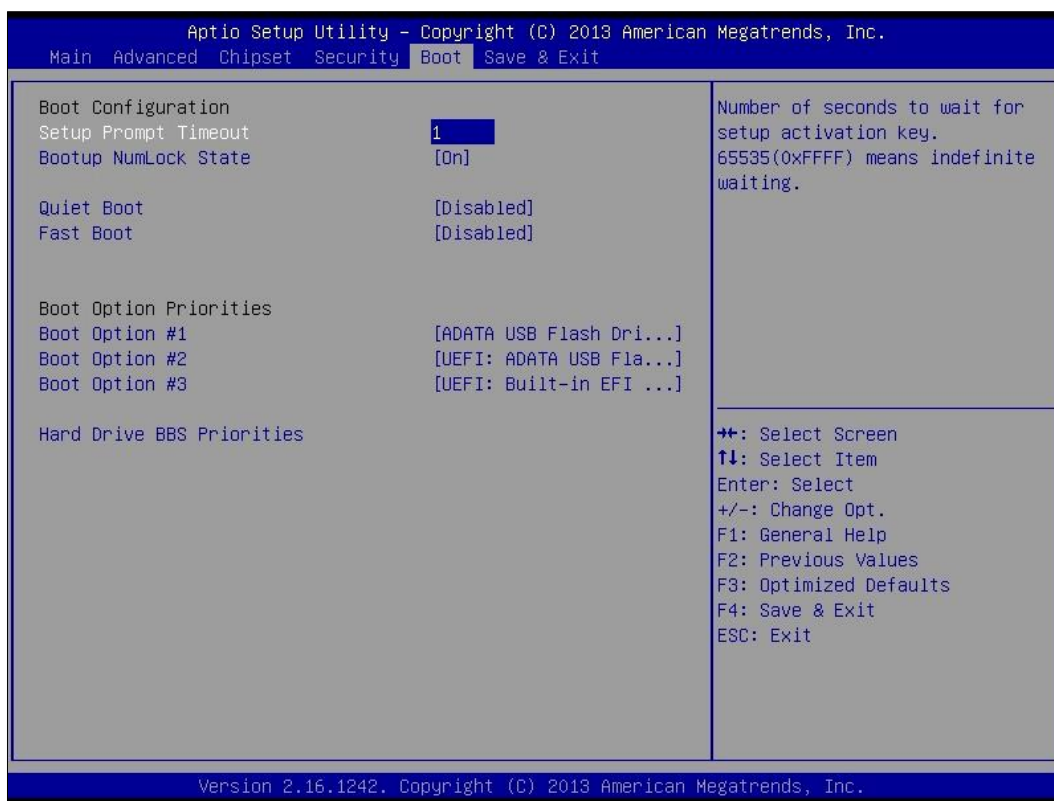

BIOS Setting	Description
Setup Prompt Timeout	Number of seconds to wait for setup activation key. 65535 (0xFFFF) means indefinite waiting.
Bootup NumLock State	Selects the keyboard NumLock state.
Quiet Boot	Enables / Disables Quiet Boot option.
Fast Boot	Enables / Disables boot with initialization of a minimal set of devices required to launch the active boot option. There no effect for BBS boot options.
Boot Option Priorities	Sets the system boot order.

4.8 Save & Exit Settings

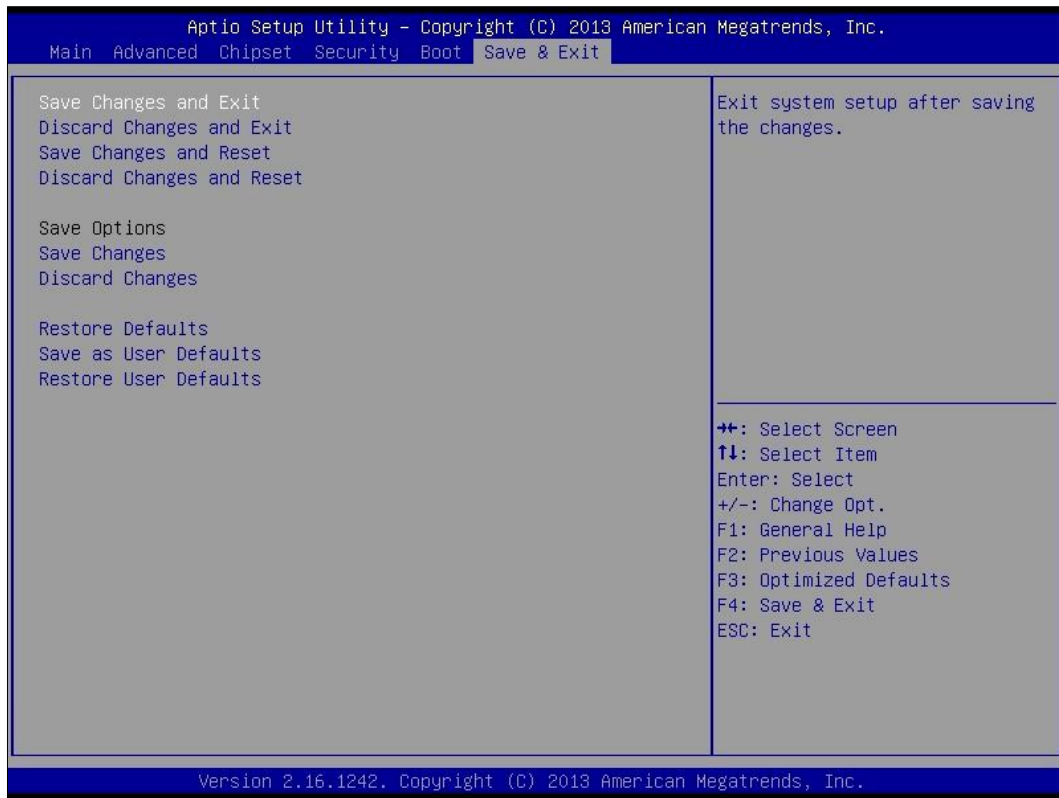

BIOS Setting	Description
Save Changes and Exit	Exits system setup after saving the changes.
Discard Changes and Exit	Exits system setup without saving any changes.
Save Changes and Reset	Resets the system after saving the changes.
Discard Changes and Reset	Resets system setup without saving any changes.
Save Changes	Saves changes done so far to any of the setup options.
Discard Changes	Discards changes done so far to any of the setup options.
Restore Defaults	Restores / Loads defaults values for all the setup options.
Save as User Defaults	Saves the changes done so far as user defaults.
Restore User Defaults	Restores the user defaults to all the setup options.

Appendix

This section provides the mapping addresses of peripheral devices and the sample code of watchdog timer configuration.

- I/O Port Address Map
- Interrupt Request Lines (IRQ)
- Digital I/O Sample Code
- Watchdog Timer Configuration

A. I/O Port Address Map

Each peripheral device in the system is assigned a set of I/O port addresses which also becomes the identity of the device. The following table lists the I/O port addresses used.

Address	Device Description
0000h-001Fh	Direct memory access controller
0000h-001Fh	PCI bus
0040h-0043h	System timer
0050h-0053h	System timer
0070h-0077h	System CMOS/real time clock
0081h-0091h	Direct memory access controller
0093h-009Fh	Direct memory access controller
00C0h-00DFh	Direct memory access controller
00F0h-00F0h	Numeric data processor
02F8h-02FFh	Communications Port (COM2)
03B0h-03BBh	Intel(R) HD Graphics 4600
03C0h-03DFh	Intel(R) HD Graphics 4600
03F8h-03FFh	Communications Port (COM1)
0D00h-FFFFh	PCI bus
E000h-EFFFh	Intel(R) 8 Series/C220 Series PCI Express Root Port #7 - 8C1C
F000h-F03Fh	Intel(R) HD Graphics 4600
F040h-F05Fh	Intel(R) 8 Series/C220 Series SMBus Controller - 8C22
F060h-F07Fh	Intel(R) 8 Series/C220 Series SATA AHCI Controller - 8C02
F0A0h-F0A3h	Intel(R) 8 Series/C220 Series SATA AHCI Controller - 8C02
F0B0h-F0B7h	Intel(R) 8 Series/C220 Series SATA AHCI Controller - 8C02
F0C0h-F0C3h	Intel(R) 8 Series/C220 Series SATA AHCI Controller - 8C02
F0D0h-F0D7h	Intel(R) 8 Series/C220 Series SATA AHCI Controller - 8C02
F0E0h-F0E7h	Intel(R) Active Management Technology - SOL (COM3)

B. Interrupt Request Lines (IRQ)

Peripheral devices use interrupt request lines to notify CPU for the service required. The following table shows the IRQ used by the devices on board.

Level	Function
IRQ0	System Timer
IRQ3	Serial Port #2
IRQ4	Serial Port #1
IRQ 10	Intel(R) 8 Series/C220 Series SMBus Controller - 8C22
IRQ 13	Numeric data processor
IRQ 16	High Definition Audio Controller
IRQ 16	Intel(R) 8 Series/C220 Series USB EHCI #2 - 8C2D
IRQ 16	Intel(R) Management Engine Interface
IRQ 19	Intel(R) 8 Series/C220 Series SATA AHCI Controller - 8C02
IRQ 19	Intel(R) Active Management Technology - SOL (COM3)
IRQ 22	High Definition Audio Controller
IRQ 23	Intel(R) 8 Series/C220 Series USB EHCI #1 - 8C26

C. Digital I/O Sample Code

1. The file NCT5523D.H

```
//-----  
// THIS CODE AND INFORMATION IS PROVIDED "AS IS" WITHOUT WARRANTY OF ANY  
// KIND, EITHER EXPRESSED OR IMPLIED, INCLUDING BUT NOT LIMITED TO THE  
// IMPLIED WARRANTIES OF MERCHANTABILITY AND/OR FITNESS FOR A  
// PARTICULAR  
// PURPOSE.  
//-----  
#ifndef __NCT5523D_H  
#define __NCT5523D_H          1  
//-----  
#define  NCT5523D_INDEX_PORT  (NCT5523D_BASE)  
#define  NCT5523D_DATA_PORT   (NCT5523D_BASE+1)  
//-----  
#define  NCT5523D_REG_LD      0x07  
//-----  
#define NCT5523D_UNLOCK      0x87  
#define  NCT5523D_LOCK       0xAA  
//-----  
unsigned int Init_NCT5523D(void);  
void Set_NCT5523D_LD( unsigned char);  
void Set_NCT5523D_Reg( unsigned char, unsigned char);  
unsigned char Get_NCT5523D_Reg( unsigned char);  
//-----  
#endif    __NCT5523D_H
```

2. The file MAIN.CPP

```
//-----
// THIS CODE AND INFORMATION IS PROVIDED "AS IS" WITHOUT WARRANTY OF ANY
// KIND, EITHER EXPRESSED OR IMPLIED, INCLUDING BUT NOT LIMITED TO THE
// IMPLIED WARRANTIES OF MERCHANTABILITY AND/OR FITNESS FOR A
// PARTICULAR
// PURPOSE.
//-----
#include <dos.h>
#include <conio.h>
#include <stdio.h>
#include <stdlib.h>
#include "NCT5523D.H"
//-----
int main (void);

void Dio5Initial(void);
void Dio5SetOutput(unsigned char);
unsigned char Dio5GetInput(void);
void Dio5SetDirection(unsigned char);
unsigned char Dio5GetDirection(void);
//-----
int main (void)
{
    char SIO;

    SIO = Init_NCT5523D();
    if (SIO == 0)
    {
        printf("Can not detect Nuvoton NCT5523D, program abort.\n");
        return(1);
    }

    Dio5Initial();

    //for GPIO20..27
    Dio5SetDirection(0x0F); //GP20..23 = input, GP24..27=output
    printf("Current DIO direction = 0x%X\n", Dio5GetDirection());

    printf("Current DIO status = 0x%X\n", Dio5GetInput());

    printf("Set DIO output to high\n");
    Dio5SetOutput(0x0F);

    printf("Set DIO output to low\n");
    Dio5SetOutput(0x00);

    return 0;
}
//-----
```

```
void Dio5Initial(void)
{
    unsigned char ucBuf;

    ucBuf = Get_NCT5523D_Reg(0x1C);
    ucBuf &= ~0x02;
    Set_NCT5523D_Reg(0x1C, ucBuf);

    Set_NCT5523D_LD(0x07); //switch to logic device
7
    //enable the GP2 group
    ucBuf = Get_NCT5523D_Reg(0x30);
    ucBuf |= 0x04;
    Set_NCT5523D_Reg(0x30, ucBuf);
}
//-----
void Dio5SetOutput(unsigned char NewData)
{
    Set_NCT5523D_LD(0x07); //switch to logic device 7
    Set_NCT5523D_Reg(0xE1, NewData);
}
//-----
unsigned char Dio5GetInput(void)
{
    unsigned char result;

    Set_NCT5523D_LD(0x07); //switch to logic device 7
    result = Get_NCT5523D_Reg(0xE1);
    return (result);
}
//-----
void Dio5SetDirection(unsigned char NewData)
{
    //NewData : 1 for input, 0 for output
    Set_NCT5523D_LD(0x07); //switch to logic device 7
    Set_NCT5523D_Reg(0xE8, NewData);
}
//-----
unsigned char Dio5GetDirection(void)
{
    unsigned char result;

    Set_NCT5523D_LD(0x07); //switch to logic device 7
    result = Get_NCT5523D_Reg(0xE8);
    return (result);
}
//-----
```

3. The file NCT5523D.CPP

```

//-----
// THIS CODE AND INFORMATION IS PROVIDED "AS IS" WITHOUT WARRANTY OF ANY
// KIND, EITHER EXPRESSED OR IMPLIED, INCLUDING BUT NOT LIMITED TO THE
// IMPLIED WARRANTIES OF MERCHANTABILITY AND/OR FITNESS FOR A
// PARTICULAR
// PURPOSE.
//-----
#include "NCT5523D.H"
#include <dos.h>
//-----
unsigned int NCT5523D_BASE;
void Unlock_NCT5523D (void);
void Lock_NCT5523D (void);
//-----
unsigned int Init_NCT5523D(void)
{
    unsigned int result;
    unsigned char ucDid;

    NCT5523D_BASE = 0x4E;
    result = NCT5523D_BASE;

    ucDid = Get_NCT5523D_Reg(0x20);
    if (ucDid == 0xC4)                //NCT5523D??
    {    goto Init_Finish; }

    NCT5523D_BASE = 0x2E;
    result = NCT5523D_BASE;

    ucDid = Get_NCT5523D_Reg(0x20);
    if (ucDid == 0xC4)                //NCT5523D??
    {    goto Init_Finish; }

    NCT5523D_BASE = 0x00;
    result = NCT5523D_BASE;

Init_Finish:
    return (result);
}
//-----
void Unlock_NCT5523D (void)
{
    outportb(NCT5523D_INDEX_PORT, NCT5523D_UNLOCK);
    outportb(NCT5523D_INDEX_PORT, NCT5523D_UNLOCK);
}
//-----
void Lock_NCT5523D (void)
{
    outportb(NCT5523D_INDEX_PORT, NCT5523D_LOCK);
}
//-----

```

```
void Set_NCT5523D_LD( unsigned char LD)
{
    Unlock_NCT5523D();
    outportb(NCT5523D_INDEX_PORT, NCT5523D_REG_LD);
    outportb(NCT5523D_DATA_PORT, LD);
    Lock_NCT5523D();
}
//-----
void Set_NCT5523D_Reg( unsigned char REG, unsigned char DATA)
{
    Unlock_NCT5523D();
    outportb(NCT5523D_INDEX_PORT, REG);
    outportb(NCT5523D_DATA_PORT, DATA);
    Lock_NCT5523D();
}
//-----
unsigned char Get_NCT5523D_Reg(unsigned char REG)
{
    unsigned char Result;
    Unlock_NCT5523D();
    outportb(NCT5523D_INDEX_PORT, REG);
    Result = inportb(NCT5523D_DATA_PORT);
    Lock_NCT5523D();
    return Result;
}
//-----
```

D. Watchdog Timer Configuration

The Watchdog Timer (WDT) is used to generate a variety of output signals after a user programmable count. The WDT is suitable for the use in the prevention of system lock-up, such as when software becomes trapped in a deadlock. Under these sorts of circumstances, the timer will count to zero and the selected outputs will be driven.

Under normal circumstance, you will need to restart the WDT at regular intervals before the timer counts to zero.

1. Sample Code: The file NCT5523D.H

```
//-----
//
// THIS CODE AND INFORMATION IS PROVIDED "AS IS" WITHOUT WARRANTY OF ANY
// KIND, EITHER EXPRESSED OR IMPLIED, INCLUDING BUT NOT LIMITED TO THE
// IMPLIED WARRANTIES OF MERCHANTABILITY AND/OR FITNESS FOR A
// PARTICULAR
// PURPOSE.
//
//-----
#ifndef __NCT5523D_H
#define __NCT5523D_H          1
//-----
#define NCT5523D_INDEX_PORT    (NCT5523D_BASE)
#define NCT5523D_DATA_PORT    (NCT5523D_BASE+1)
//-----
#define NCT5523D_REG_LD        0x07
//-----
#define NCT5523D_UNLOCK        0x87
#define NCT5523D_LOCK          0xAA
//-----
unsigned int Init_NCT5523D(void);
void Set_NCT5523D_LD( unsigned char);
void Set_NCT5523D_Reg( unsigned char, unsigned char);
unsigned char Get_NCT5523D_Reg( unsigned char);
//-----
#endif    //__NCT5523D_H
```

2. Sample Code: The file MAIN.CPP

```
//-----  
//  
// THIS CODE AND INFORMATION IS PROVIDED "AS IS" WITHOUT WARRANTY OF ANY  
// KIND, EITHER EXPRESSED OR IMPLIED, INCLUDING BUT NOT LIMITED TO THE  
// IMPLIED WARRANTIES OF MERCHANTABILITY AND/OR FITNESS FOR A  
// PARTICULAR  
// PURPOSE.  
//  
//-----  
#include <dos.h>  
#include <conio.h>  
#include <stdio.h>  
#include <stdlib.h>  
#include "NCT5523D.H"  
//-----  
int main (void);  
  
void WDTInitial(void);  
void WDTEnable(unsigned char);  
void WDTDisable(void);  
  
//-----  
int main (void)  
{  
    char SIO;  
  
    SIO = Init_NCT5523D();  
    if (SIO == 0)  
    {  
        printf("Can not detect Nuvoton NCT5523D, program abort.\n");  
        return(1);  
    }  
  
    WDTInitial();  
  
    WDTEnable(10);  
  
    WDTDisable();  
  
    return 0;  
}  
//-----  
void WDTInitial(void)  
{  
    unsigned char bBuf;  
    Set_NCT5523D_LD(0x08); //switch to logic device 8  
    bBuf = Get_NCT5523D_Reg(0x30);  
    bBuf &= (~0x01);  
    Set_NCT5523D_Reg(0x30, bBuf); //Enable WDTO  
}  
//-----
```

```
void WDTEnable(unsigned char NewInterval)
{
    unsigned char bBuf;

    Set_NCT5523D_LD(0x08);                //switch to logic device 8
    Set_NCT5523D_Reg(0x30, 0x01);        //enable timer

    bBuf = Get_NCT5523D_Reg(0xF0);
    bBuf &= (~0x08);
    Set_NCT5523D_Reg(0xF0, bBuf);        //count mode is second

    Set_NCT5523D_Reg(0xF1, NewInterval); //set timer
}
//-----
void WDTDisable(void)
{
    Set_NCT5523D_LD(0x08);                //switch to logic device 8
    Set_NCT5523D_Reg(0xF1, 0x00);        //clear watchdog timer
    Set_NCT5523D_Reg(0x30, 0x00);        //watchdog disabled
}
//-----
```

3. Sample Code: The file NCT5523D.CPP

```
//-----  
//  
// THIS CODE AND INFORMATION IS PROVIDED "AS IS" WITHOUT WARRANTY OF ANY  
// KIND, EITHER EXPRESSED OR IMPLIED, INCLUDING BUT NOT LIMITED TO THE  
// IMPLIED WARRANTIES OF MERCHANTABILITY AND/OR FITNESS FOR A  
// PARTICULAR  
// PURPOSE.  
//  
//-----  
#include "NCT5523D.H"  
#include <dos.h>  
//-----  
unsigned int NCT5523D_BASE;  
void Unlock_NCT5523D (void);  
void Lock_NCT5523D (void);  
//-----  
unsigned int Init_NCT5523D(void)  
{  
    unsigned int result;  
    unsigned char ucDid;  
  
    NCT5523D_BASE = 0x4E;  
    result = NCT5523D_BASE;  
  
    ucDid = Get_NCT5523D_Reg(0x20);  
    if (ucDid == 0xC4)                //NCT5523D??  
    {    goto Init_Finish; }  
  
    NCT5523D_BASE = 0x2E;  
    result = NCT5523D_BASE;  
  
    ucDid = Get_NCT5523D_Reg(0x20);  
    if (ucDid == 0xC4)                //NCT5523D??  
    {    goto Init_Finish; }  
  
    NCT5523D_BASE = 0x00;  
    result = NCT5523D_BASE;  
  
Init_Finish:  
    return (result);  
}  
//-----  
void Unlock_NCT5523D (void)  
{  
    outportb(NCT5523D_INDEX_PORT, NCT5523D_UNLOCK);  
    outportb(NCT5523D_INDEX_PORT, NCT5523D_UNLOCK);  
}  
//-----
```



```
void Lock_NCT5523D (void)
{
    outportb(NCT5523D_INDEX_PORT, NCT5523D_LOCK);
}
//-----
void Set_NCT5523D_LD( unsigned char LD)
{
    Unlock_NCT5523D();
    outportb(NCT5523D_INDEX_PORT, NCT5523D_REG_LD);
    outportb(NCT5523D_DATA_PORT, LD);
    Lock_NCT5523D();
}
//-----
void Set_NCT5523D_Reg( unsigned char REG, unsigned char DATA)
{
    Unlock_NCT5523D();
    outportb(NCT5523D_INDEX_PORT, REG);
    outportb(NCT5523D_DATA_PORT, DATA);
    Lock_NCT5523D();
}
//-----
unsigned char Get_NCT5523D_Reg(unsigned char REG)
{
    unsigned char Result;
    Unlock_NCT5523D();
    outportb(NCT5523D_INDEX_PORT, REG);
    Result = inportb(NCT5523D_DATA_PORT);
    Lock_NCT5523D();
    return Result;
}
//-----
```