

SI-324-N

Mid-Range Digital Signage Player

User's Manual

Version 1.0A
(November 2023)



Copyright

© 2023 IBASE Technology, Inc. All rights reserved.

No part of this publication may be reproduced, copied, stored in a retrieval system, translated into any language or transmitted in any form or by any means, electronic, mechanical, photocopying, or otherwise, without the prior written consent of IBASE Technology, Inc. (hereinafter referred to as "IBASE").

Disclaimer

IBASE reserves the right to make changes and improvements to the products described in this document without prior notice. Every effort has been made to ensure the information in the document is correct; however, IBASE does not guarantee this document is error-free. IBASE assumes no liability for incidental or consequential damages arising from misapplication or inability to use the product or the information contained herein, nor for any infringements of rights of third parties, which may result from its use.

Trademarks

All the trademarks, registrations and brands mentioned herein are used for identification purposes only and may be trademarks and/or registered trademarks of their respective owners.

Compliance

CE

In a domestic environment, this product may cause radio interference in which case users may be required to take adequate measures.

FCC

This product has been tested and found to comply with the limits for a Class B device, pursuant to Part 15 of the FCC Rules. These limits are designed to provide reasonable protection against harmful interference in a residential installation. This equipment generates, uses and can radiate radio frequency energy and, if not installed and used in accordance with manufacturer's instructions, may cause harmful interference to radio communications.

WEEE



This product must not be disposed of as normal household waste, in accordance with the EU directive of for waste electrical and electronic equipment (WEEE - 2012/19/EU). Instead, it should be disposed of by returning it to a municipal recycling collection point. Check local regulations for disposal of electronic products.

Green IBASE



This product is compliant with the current RoHS restrictions and prohibits use of the following substances in concentrations exceeding 0.1% by weight (1000 ppm) except for cadmium, limited to 0.01% by weight (100 ppm).

- Lead (Pb)
- Mercury (Hg)
- Cadmium (Cd)
- Hexavalent chromium (Cr6+)
- Polybrominated biphenyls (PBB)
- Polybrominated diphenyl ether (PBDE)

Important Safety Information

Carefully read the precautions before using the device.

Environmental conditions:

- Lay the device horizontally on a stable and solid surface in case the device may fall, causing serious damage.
- Leave plenty of space around the device and do not block the openings for ventilation. **NEVER DROP OR INSERT ANY OBJECTS OF ANY KIND INTO THE VENTILATION OPENINGS.**
- Use this product in environments with ambient temperatures between 0°C and 45°C.
- **DO NOT LEAVE THIS DEVICE IN AN ENVIRONMENT WHERE THE STORAGE TEMPERATURE MAY IS BELOW -20° C OR ABOVE 80° C.** This could damage the device. The device must be used in a controlled environment.

Care for your iBASE products:

- Before cleaning the device, turn it off and unplug all cables such as power in case a small amount of electrical current may still flow.
- Use neutral cleaning agents or diluted alcohol to clean the device chassis with a cloth. Then wipe the chassis with a dry cloth.
- Vacuum the dust with a computer vacuum cleaner to prevent the air vent or slots from being clogged.



WARNING

Attention during use:

- Do not use this product near water.
- Do not spill water or any other liquids on your device.
- Do not place heavy objects on the top of the device.
- Operate this device from the type of power indicated on the marking label. If you are not sure of the type of power available, consult your distributor or local power company.
- Do not walk on the power cord or allow anything to rest on it.
- If you use an extension cord, make sure that the total ampere rating of the product plugged into the extension cord does not exceed its limits.

Avoid Disassembly

Do not disassemble, repair or make any modification to the device. Doing so could generate hazards and cause damage to the device, even bodily injury or property damage, and will void any warranty.



CAUTION

There is danger of explosion if internal lithium-ion battery is replaced by an incorrect type. Replace only with the same or equivalent type recommended by the manufacturer. Dispose of used batteries according to the manufacturer's instructions.

Warranty Policy

- **IBASE standard products:**

24-month (2-year) warranty from the date of shipment. If the date of shipment cannot be ascertained, the product serial numbers can be used to determine the approximate shipping date.

- **3rd-party parts:**

12-month (1-year) warranty from delivery for the 3rd-party parts that are not manufactured by IBASE, such as CPU, CPU cooler, memory, storage devices, power adapter, panel and touchscreen.

* PRODUCTS, HOWEVER, THAT FAIL DUE TO MISUSE, ACCIDENT, IMPROPER INSTALLATION OR UNAUTHORIZED REPAIR SHALL BE TREATED AS OUT OF WARRANTY AND CUSTOMERS SHALL BE BILLED FOR REPAIR AND SHIPPING CHARGES.

Technical Support & Services

1. Visit the IBASE website at www.ibase.com.tw to find the latest information about the product.
2. If you need any further assistance from your distributor or sales representative, prepare the following information of your product and elaborate upon the problem.
 - Product model name
 - Product serial number
 - Detailed description of the problem
 - The error messages in text or in screenshots if there is any
 - The arrangement of the peripherals
 - Software in use (such as OS and application software, including the version numbers)
3. If repair service is required, you can download the RMA form from the IBASE's website. Fill out the form and contact your distributor or sales representative.

Table of Contents

Chapter 1	General Information	1
1.1	Introduction	2
1.2	Features.....	3
1.3	Packing List	3
1.4	Optional Accessories	3
1.5	Specifications.....	4
1.6	Product View.....	Error! Bookmark not defined.
1.7	Dimensions	7
Chapter 2	Hardware Installation & Motherboard Information	8
2.1	Installation / Replacement.....	9
2.2	Pin Assignment for DC Power Input Connector.....	13
2.3	Pin Assignment for COM1 RS-232 Port	13
2.4	Setting the Jumpers	14
2.5	Jumper & Connector Locations on Motherboard	15
2.6	Jumpers & Connectors Quick Reference	16
Chapter 3	Driver Installation	19
3.1	Introduction	20
3.2	AMD Radeon™ Graphics Driver Installation.....	20
3.3	HD Audio Driver Installation	21
3.4	LAN Driver Installation	22
Chapter 4	BIOS Setup.....	23
4.1	Introduction	24
4.2	BIOS Setup.....	24
4.3	Main Settings	25
4.4	Advanced Settings	25
4.5	Chipset Settings.....	33
4.6	Security Settings	35
4.7	Boot Settings.....	37
4.8	Save & Exit Settings.....	38

Appendix	39
A. SDR and HDR Resolution Support.....	40
A.1 Maximum SDR Resolution (Clone/Extended mode)	40
A.2 Maximum HDR Resolution (Clone/Extended mode)	40
B. AMD Eyefinity Multiple Displays Configuration	41
B.1 Setting Up AMD Eyefinity Using Quick Setup	41
B.2 Customizing AMD Eyefinity Using Try Advanced Setup.....	45
C. I/O Port Address Map.....	51
D. Interrupt Request Lines (IRQ)	53
E. Watchdog Timer Configuration.....	55

Chapter 1

General Information

The information provided in this chapter includes:

- Features
- Packing List
- Accessories
- Specifications
- Product View
- Dimensions

1.1 Introduction

The SI-324 is a 4K digital signage player powered by the new AMD Ryzen™ Embedded V1000 processors that provide outstanding CPU performance and noticeable increase in GPU performance than previous solutions. With the new integrated AMD Radeon™ Vega graphics with up to 11 compute units, SI-324 delivers four independent HDMI 2.0 displays with up to 4K at 60 Hz resolution in each display and supports up to 2x 4K at 60 Hz or 4x FHD at 60 Hz crisp content video playback.

The SI-324 integrates the IBASE iControl intelligent energy-saving green technology and the Observer remote monitoring technology to enable energy savings, automatic power-on/off scheduling, remote monitoring, automatic power recovery, low temperature boot protection, and smart operating system restoration. It comes built in with hardware EDID (Extended Display Identification Data) analog function remotely controlled by an IBASE utility to prevent problems caused by connecting a display, disconnection of display cables or unrecognized displays. These problems are manifested in the form of black screen, wrong screen resolution and color distortion.

The SI-324 has flexible video wall configurations that are suitable a broad range of applications including restaurant menu boards and electronic displays in banks, airports and shopping malls to convey dynamic information and promotions to targeted audience. Housed in an elegant black and white case with smooth edges, it has a segregated ventilation to keep dust away from system components and thus improve system reliability. Supporting up to 32GB of fast dual-channel DDR4 memory, SI-324 offers advanced expansion and interfaces including one Mini PCI-E, one M.2 E-Key, one SIM card slot, two USB 3.0, one USB 2.0, two GbE RJ45 LAN and HD audio.



1.2 Features

- Segregated flow ventilation design
- iControl intelligent energy-saving & Observer remote monitoring technologies
- AMD Ryzen™ Embedded V1000 series
- Vega GPU with up to 11 Compute Units
- 4 x HDMI 2.0 with independent audio output support
- Built-in hardware EDID emulation function with the software setting mode
- 2 x DDR4 SO-DIMM 2400 MHz, dual channel, expandable up to 32 GB
- 1 x Mini PCIe slot for WiFi, Bluetooth, 4G LTE or capture card options
- 1 x M.2 E2230 slot for WiFi, Bluetooth, 4G LTE options
- 1 x M.2 M2280 for storage

1.3 Packing List

Your product package should include the items listed below. If any of the items below is missing, contact the distributor or the dealer from whom you purchased the product.

- SI-324 Digital Signage Player
- Power Adapter
- Power Cord

1.4 Optional Accessories

IBASE provide optional accessories as follows. Please contact us or your dealer if you need any.

- VESA Mounting Bracket

1.5 Specifications

Product	SI-324-N
System	
Mainboard	MBD324
Operating System	<ul style="list-style-type: none"> • Windows 10 IoT Enterprise 64-bit • Linux Ubuntu 64-bit
CPU	AMD Ryzen™ Embedded V1807B, 3.35GHz / 3.8 GHz
Chipset	AMD Integrated SoC
Memory	2 x DDR4 SO-DIMM 2400 MHz, dual channel, expandable up to 32 GB
Graphics	AMD next-gen. Vega GPU integrated
LAN Controller	2 x Realtek RTL8111H GbE LAN controllers
Super I/O	Fintek F81846AD
Storage	1 x M.2 M2280 slot
Power Requirement	DC-In 12V
Power Supply	150W power adapter
Watchdog	Watchdog Timer 256 segments, 0, 1, 2...255 sec/min
iControl	Yes
Chassis	Aluminum and SGCC, black & white
Mounting	Slim design with wall mount holes
Dimensions (W x H x D)	269 x 31.5 x 193 mm (10.59" x 1.24" x 7.59")
Net Weight	2.1 kg (4.63 lb)
Certificate	CE, FCC class B, cULus, CCC
I/O Ports	
Power Jack	1 x DC-In power jack
Display Interface	4 x HDMI 2.0 with hardware EDID emulation
LAN	1 x RJ45 GbE LAN
Serial	1 x COM RS-232 port (RJ50 connector)
USB	<ul style="list-style-type: none"> • 2 x USB 3.0 • 1 x USB 2.0
Audio Jack	1 x Line-Out

Expansion	<ul style="list-style-type: none"> • 1 x M.2 E2230 for WiFi / BT / 4G LTE options • 1 x Mini-PCIe (full-size) for WiFi / BT / 4G LTE / capture card options • 1 x SIM card slot
Environment	
Temperature	<ul style="list-style-type: none"> • Operating: 0 ~ 45 °C (32 ~ 113 °F) • Storage: -20 ~ 80 °C (-4 ~ 176 °F)
Relative Humidity	10 ~ 90% at 45 °C (non-condensing)
Vibration Protection	M.2 card: random operation 5 grms, 5~500 Hz

All specifications are subject to change without prior notice.

Note: The product performance relies on the system functioning as a whole. The level of CPU/APU/GPU processor, the interaction among the processor and the memory and storage bandwidth, or the functionality of the digital signage application software may affect the product performance.

1.6 Product View

Front View

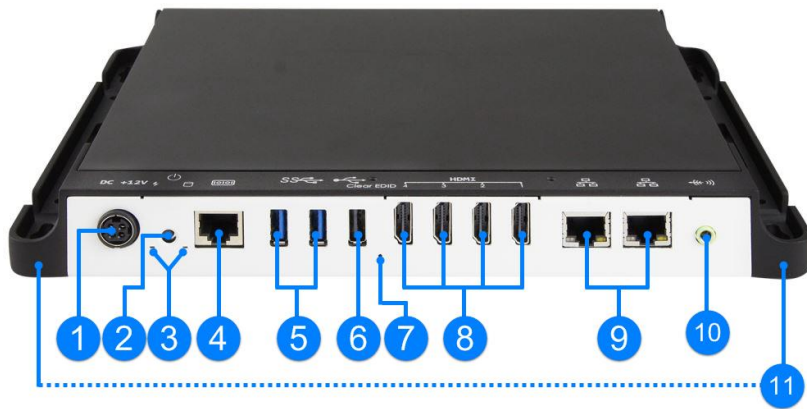

No.	Name	No.	Name
1	DC Power Input	7	Clear EDID Button*
2	Power Button	8	HDMI Ports
3	LED Indicators for Power & HDD	9	GbE LAN Ports
4	COM1 RS-232 Port (RJ50 connector)	10	Audio Line-Out Jack
5	USB 3.0 Port	11	Wall Mounting Chassis
6	USB 2.0 Port		

* Be sure to press the EDID Button to acquire or change the EDID data when the connected display/monitor cannot be recognized, or the displayed image does not fit the screen.

Oblique View



1.7 Dimensions

Unit: mm

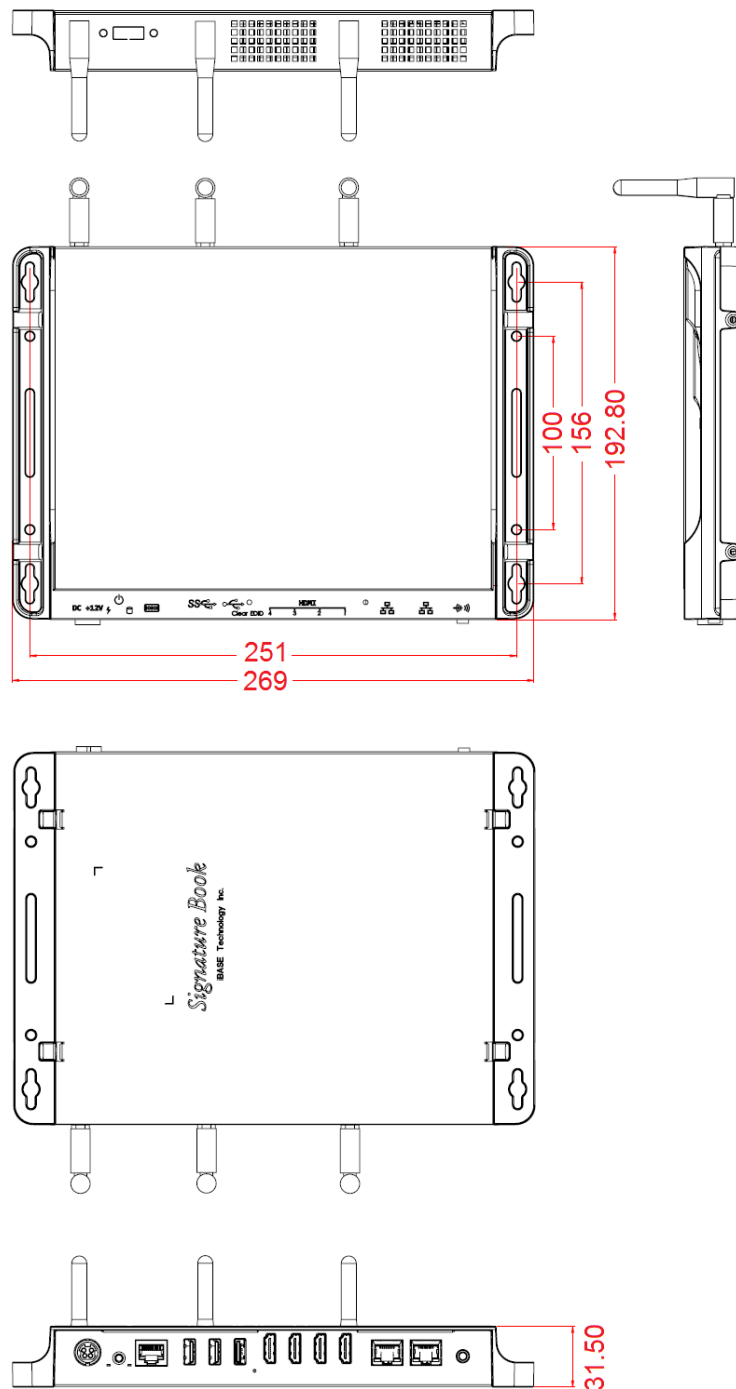

Chapter 2

Hardware Installation & Motherboard Information

The information provided in this chapter includes:

- Installation of memory, M.2 and mini PCIe cards
- Information and locations of connectors

2.1 Installation / Replacement

You need to remove the device bottom chassis firstly before installations.

Remove 4 screws as indicated below and pull out the device bottom chassis to install or replace the 1st memory module, mini-PCIe card, M.2 M2280 & E2230 cards, and SIM card.

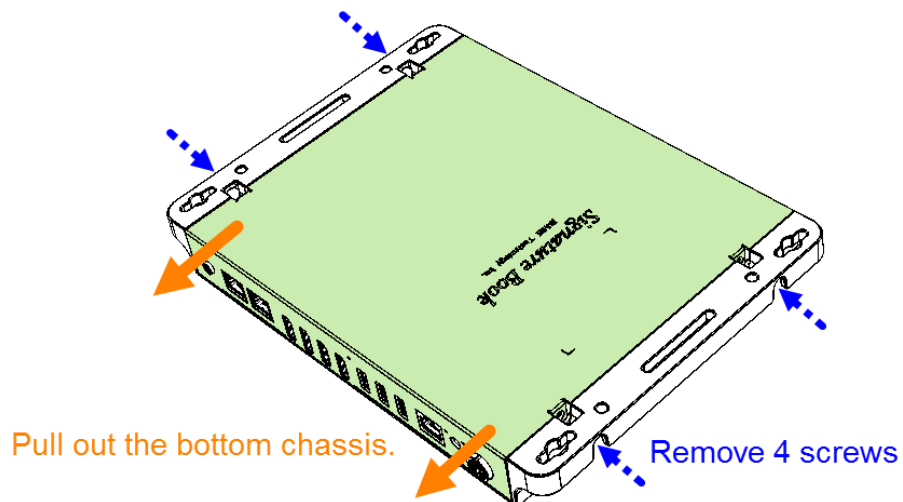

If you need to install or replace the 2nd memory module, move the jumper caps, or replace the lithium battery, you also need to perform the following steps.

1. Remove the following 3 screws to remove the M.2 heatsink.

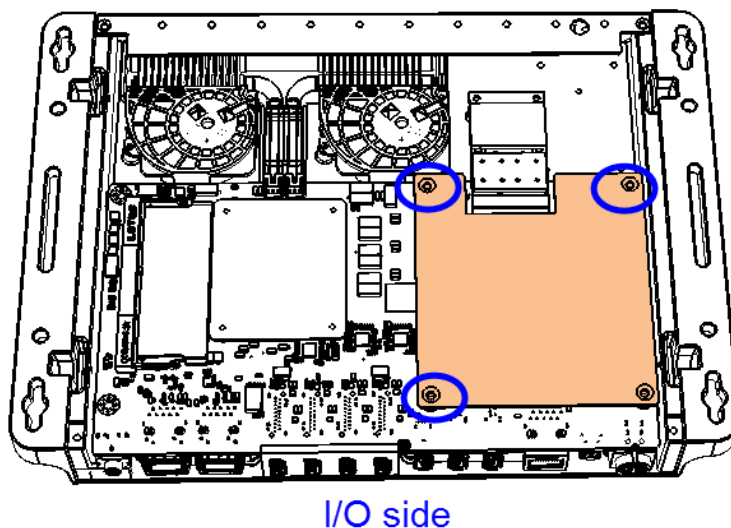

2. Remove 3 brass standoffs indicated by red circles and 3 screws indicated by blue circles to free up the motherboard.

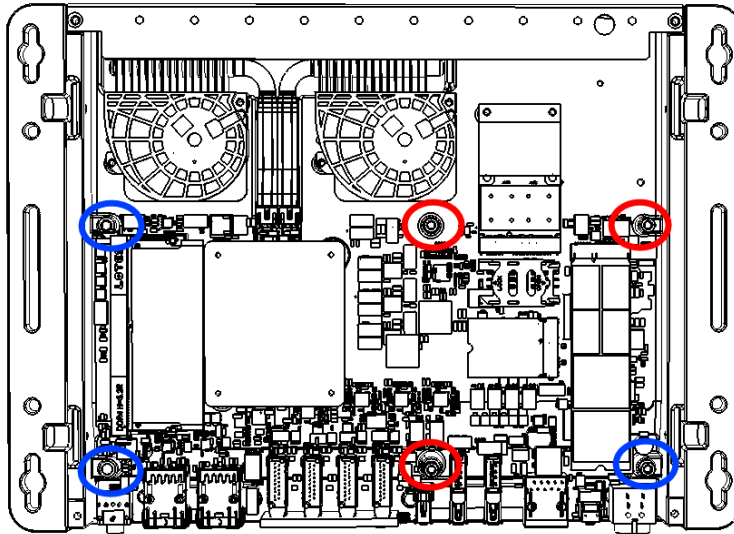

2.1.1 Memory

To install the modules, locate the memory slot on the motherboard and perform the following steps:

1. Press the ejector tab of the memory slot down and outwards with your fingertips.

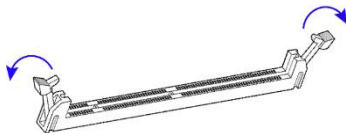

2. Hold the memory module and align the key of the module with that on the memory slot.
3. Gently push the module in an upright position until the ejector tabs of the memory slot close to hold the module in place when the module touches the bottom of the slot.

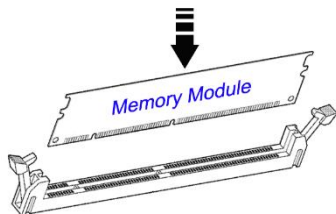

To remove the module, press the ejector tabs outwards with your fingertips to eject the module.

2.1.2 Mini-PCle & M.2 Cards

1. Locate the mini-PCle or M.2 slot inside the device.
2. Align the key of the mini-PCle card to the mini-PCle interface, and insert the card slantwise. (Insert the M.2 card in the same way.)

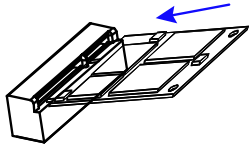

3. Push the mini-PCle card down and fix it with the an M2 screw. (Fix the M.2 network card with an M3 screw.)

Mini PCle:

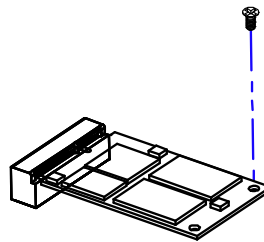
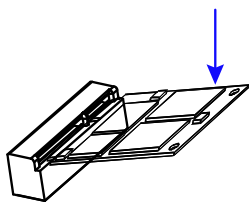

M.2:

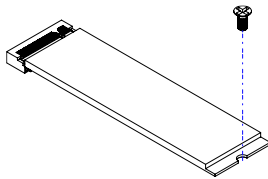

2.1.3 WiFi / 3G / 4G Antenna Installation

Thread the WiFi / 3G / 4G antenna extension cable through an antenna hole of the front I/O cover and fasten the antenna as shown below. Then apply adhesive to the edge of the hex nut behind the front I/O cover to prevent the extension cable from falling if the cable becomes loose.

1. Thread and fasten the hex nut and the washer. Then install the antenna.

2. Apply adhesive around here.

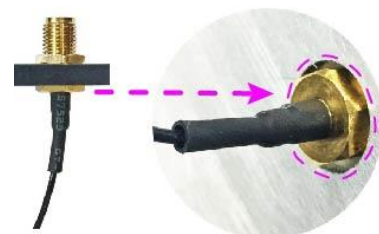
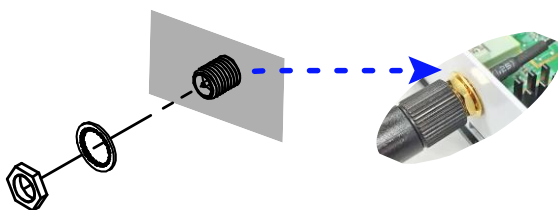

Info: The diameter of the nut is around 6.35 mm (0.25"-36UNC).

2.1.4 Mounting Installation

Requirements

Before mounting the system, ensure that you have enough room for the power adaptor and signal cable routing, and have good ventilation for the power adaptor. The method of mounting must be able to support weight of the SI-61S plus the weight of the suspending cables attached to the system. Use the following methods for mounting your system:

Wall Mounting Installation

Prepare the screws (M3) needed to install the device on the wall as shown below.

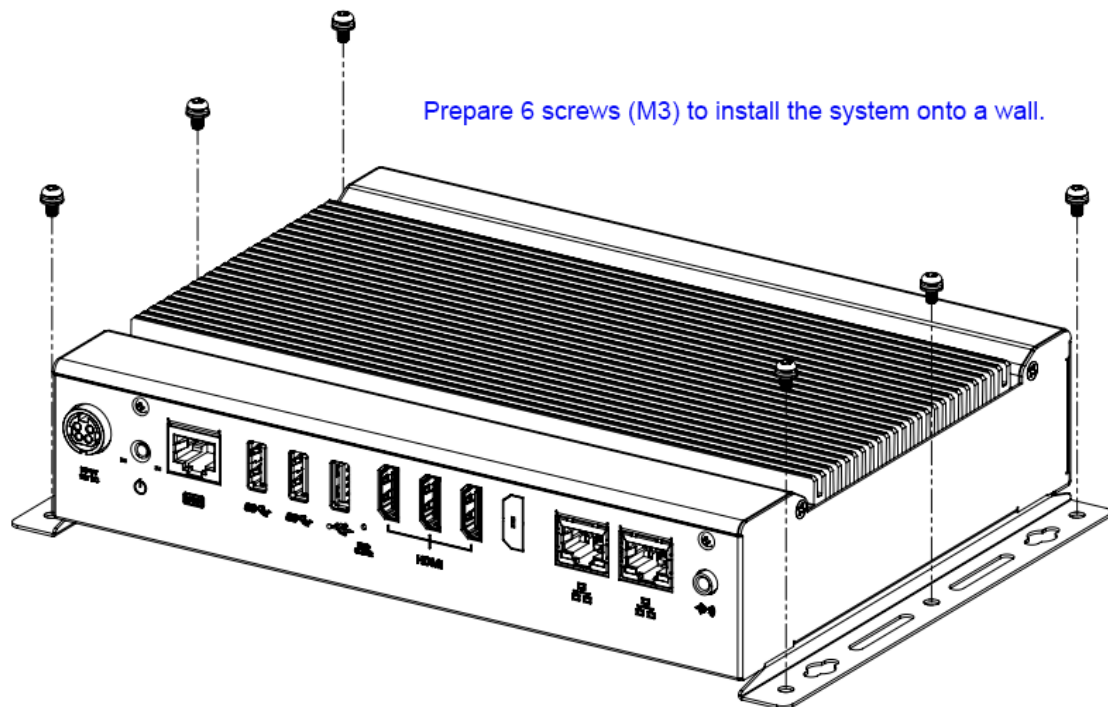

2.2 Pin Assignment for DC Power Input Connector



Pin	Assignment	Pin	Assignment
1	Ground	2	Ground
3	+12V	4	+12V

2.3 Pin Assignment for COM1 RS-232 Port



COM1 port is jumper-less and configurable in BIOS.

Pin	Assignment	Pin	Assignment
1	DSR, Data set ready	6	DCD, Data carrier detect
2	Ground	7	DTR, Data terminal ready
3	Ground	8	CTS, Clear to send
4	TX, Transmit	9	RTS, Request to send
5	RX, Receive	10	RI, Ring Indicator

2.4 Setting the Jumpers

Set up and configure your SI-613 by using jumpers for various settings and features according to your needs and applications. Contact your supplier if you have doubts about the best configuration for your use.

2.4.1 How to Set Jumpers

Jumpers are short-length conductors consisting of several metal pins with a non-conductive base mounted on the circuit board. Jumper caps are used to have the functions and features enabled or disabled. If a jumper has 3 pins, you can connect either PIN1 to PIN2 or PIN2 to PIN3 by shorting.

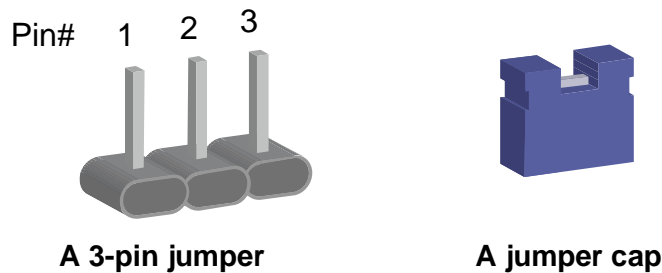

Refer to the illustration below to set jumpers.

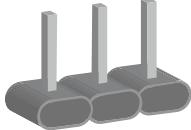
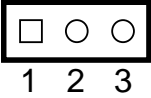
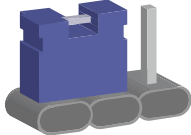
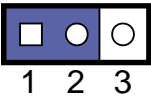
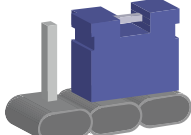
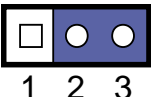
Pin closed	Oblique view	Schematic illustration
Open		
1-2		
2-3		

When two pins of a jumper are encased in a jumper cap, this jumper is **closed**, i.e. turned **On**.

When a jumper cap is removed from two jumper pins, this jumper is **open**, i.e. turned **Off**.

2.5 Jumper & Connector Locations on Motherboard

Motherboard: MBD324

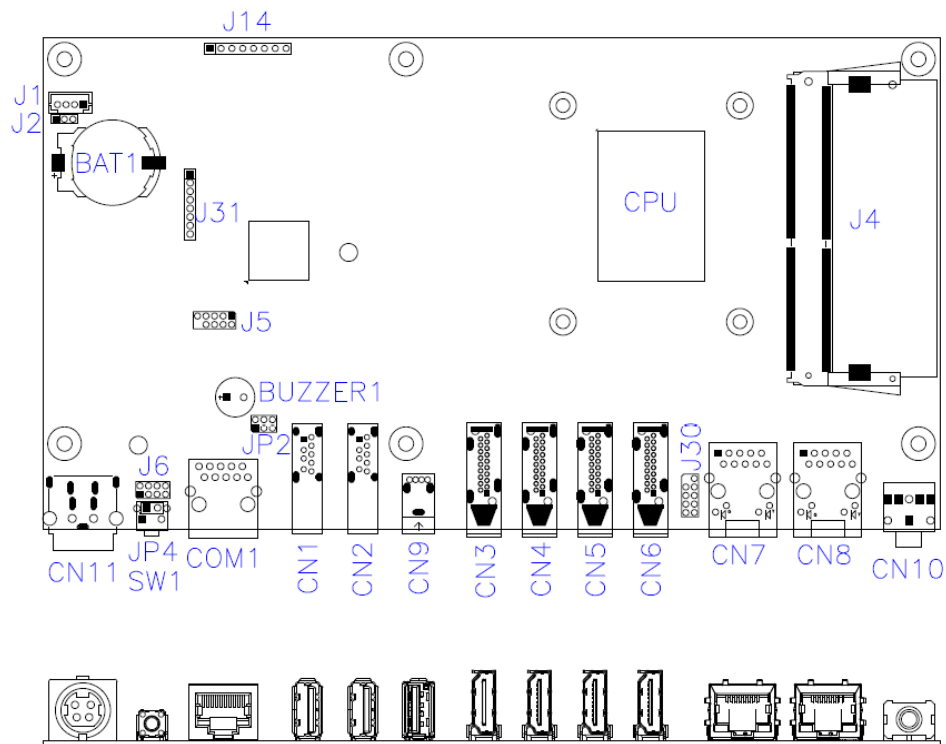

MBD324 – top and I/O

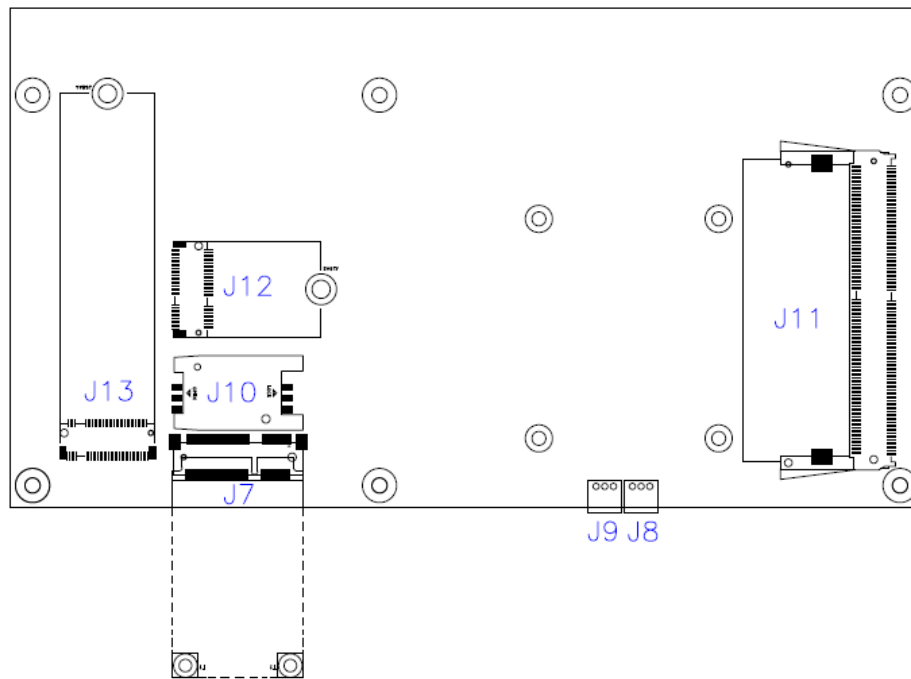

MBD324 - bottom

2.6 Jumpers & Connectors Quick Reference

Jumpers:

Function	Connector Name	Page
COM1 RS-232 Power Selection	JP2	17
Clear CMOS Data	J2	17

Connectors:

Function	Connector Name	Page
System Fan Power Connector	J8	18
CPU Fan Power Connector	J9	18
USB 3.0 Port	CN1, CN2	--
HDMI 2.0 Port	CN3, CN4, CN5, CN6	--
GbE LAN Port	CN7, CN8	--
USB 2.0 Port	CN9	--
Audio Line-Out Jack	CN10	--
DC Power Input Connector ^[1]	CN11	--
COM1 RS-232 Port ^[2]	COM1	--
Power Button	SW1	--
Clear EDID Button*	SW2	--
Full-Size Mini-PCIe Slot	J7	--
SIM Card Socket	J10	--
DDR4 Memory Slot	J4, J11	--
M.2 E3042 Slot	J12	--
M.2 M2280 Slot	J13	--
Factory Use Only	J1, J5, J14, J30, J31,	--

[1]: Refer to 2.2 Pin Assignment for DC Power Input Connector.

[2]: Refer to 2.3 Pin Assignment for COM1 RS-232 Port.

* Be sure to press the EDID Button to acquire or change the EDID data when the connected display/monitor cannot be recognized, or the displayed image does not fit the screen.

2.6.1 COM1 RS-232 Power (JP2)

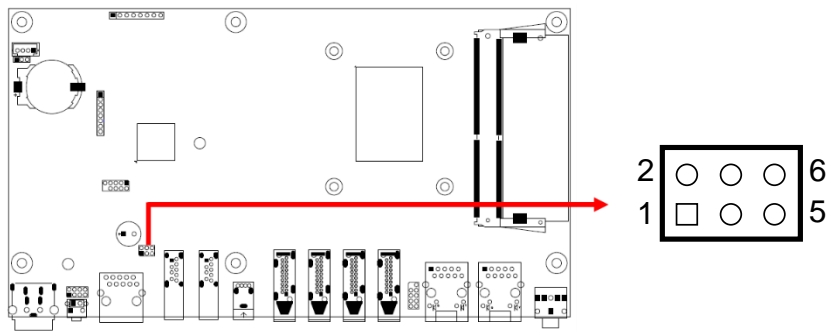

Function	Pin closed	Illustration
+12V	1-3	
RI (default)	3-4	
+5V	3-5	

2.6.2 Clear CMOS Data (J2)

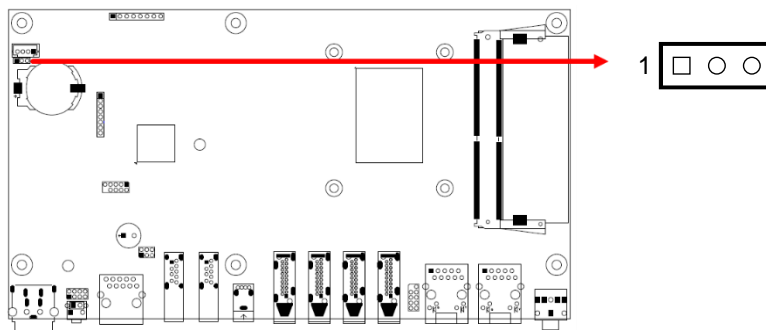

Function	Pin closed	Illustration
Normal (default)	1-2	
Clear CMOS	2-3	

2.6.3 System Fan Power Connector (J8)

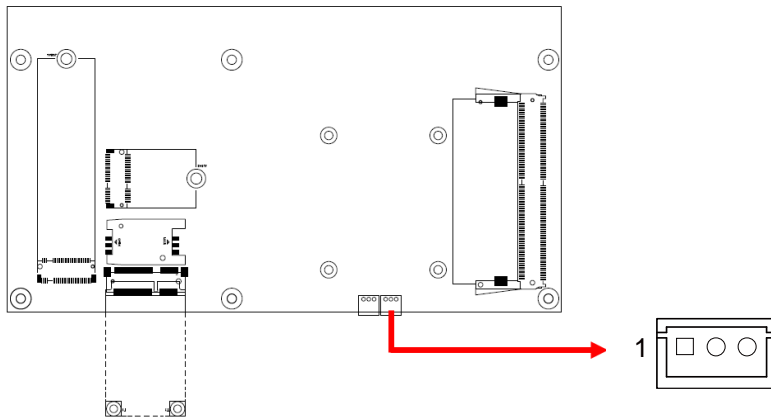

Pin	Signal Name	Pin	Signal Name
1	Ground	3	Rotation detection
2	+12V		

2.6.4 CPU Fan Power Connector (J9)

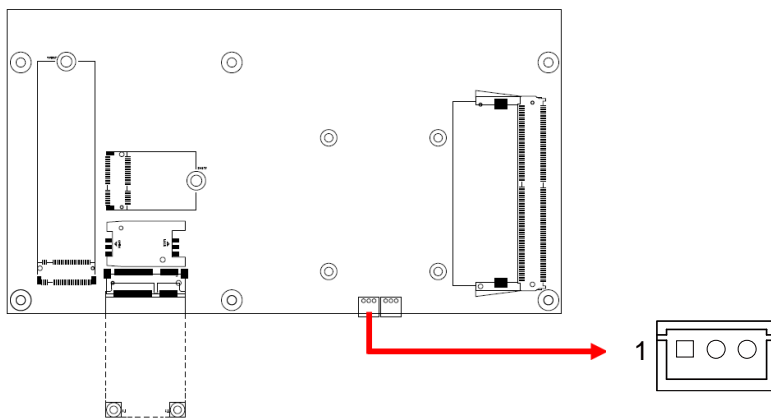

Pin	Signal Name	Pin	Signal Name
1	Ground	3	Rotation detection
2	+12V		

Chapter 3

Driver Installation

The information provided in this chapter includes:

- AMD Radeon™ Graphics Driver Installation
- HD Audio Driver Installation
- LAN Driver Installation

3.1 Introduction

This section describes the installation procedures for software drivers. The software drivers are available on IBASE website www.ibase.com.tw. Go to the download page of the product. Copy the compressed drivers file to your computer. Double click the file to decompress it. Run “CDGuide” to go to the main drivers page.

3.2 AMD Radeon™ Graphics Driver Installation

1. Run the **Setup.exe** file.
2. Accept the license agreement to continue.

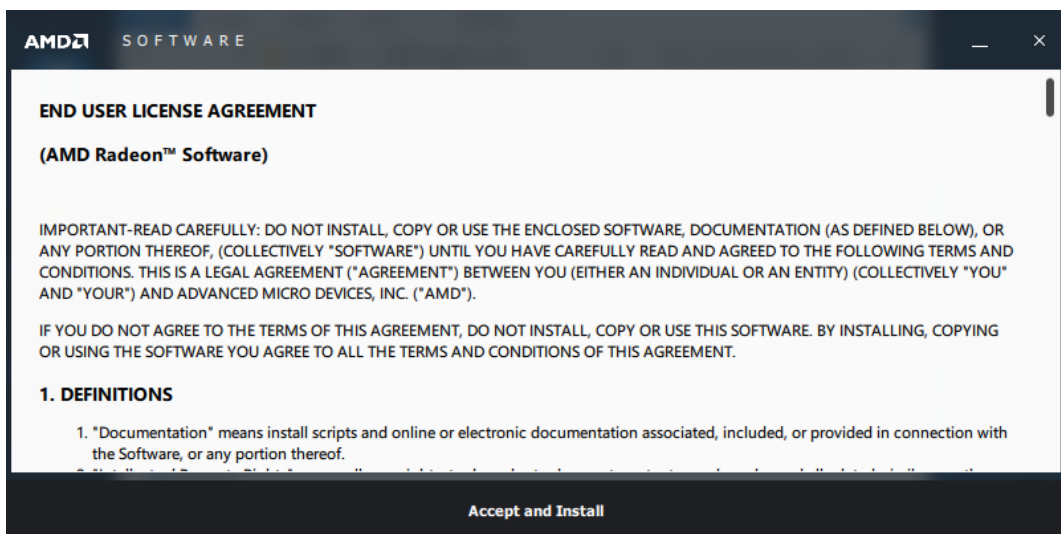

3. Choose either **Express Install** or **Custom Install**.

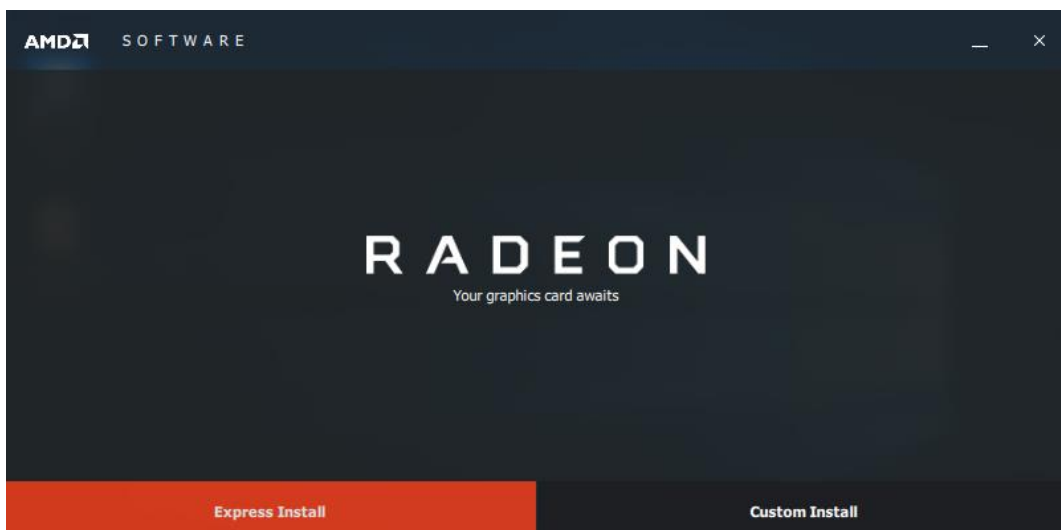

4. When the driver is completely installed, restart the computer for changes to take effect.

3.3 HD Audio Driver Installation

1. Run the **Setup.exe** file.
2. On the *Welcome* screen of the InstallShield Wizard, click **Next** for installation.

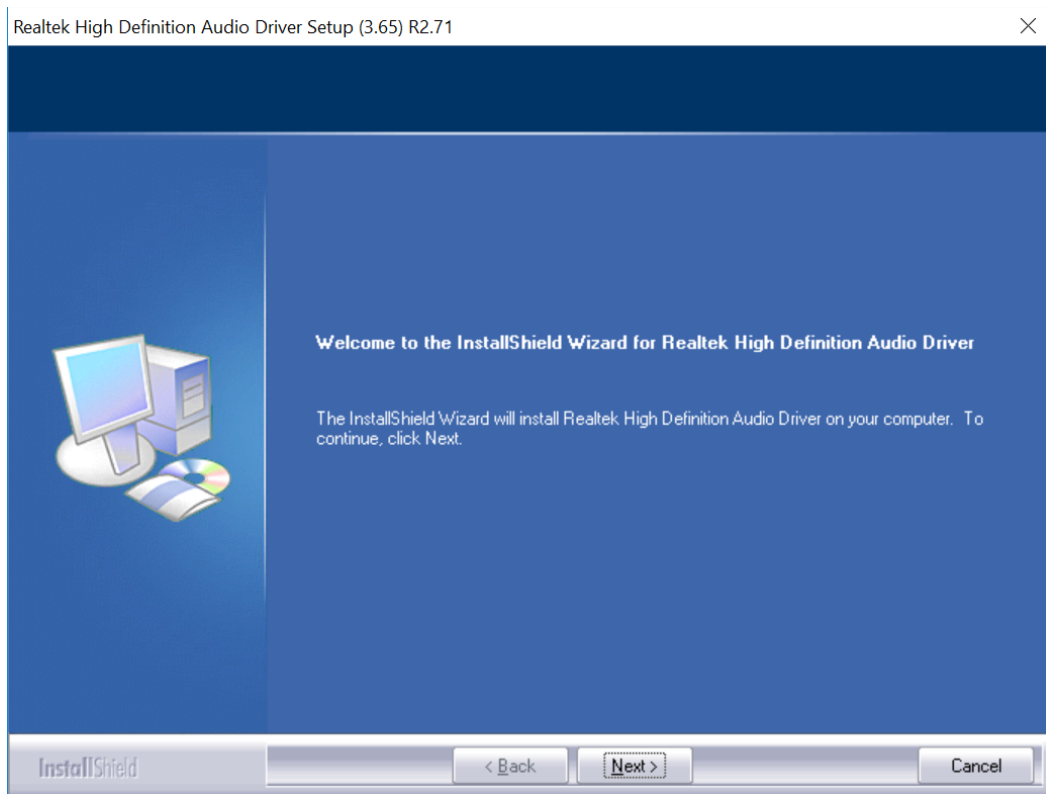

3. When the driver is completely installed, restart the computer for changes to take effect.

3.4 LAN Driver Installation

1. Run the **Setup.exe** file.
2. On the *Welcome* screen of the InstallShield Wizard, click **Next**.

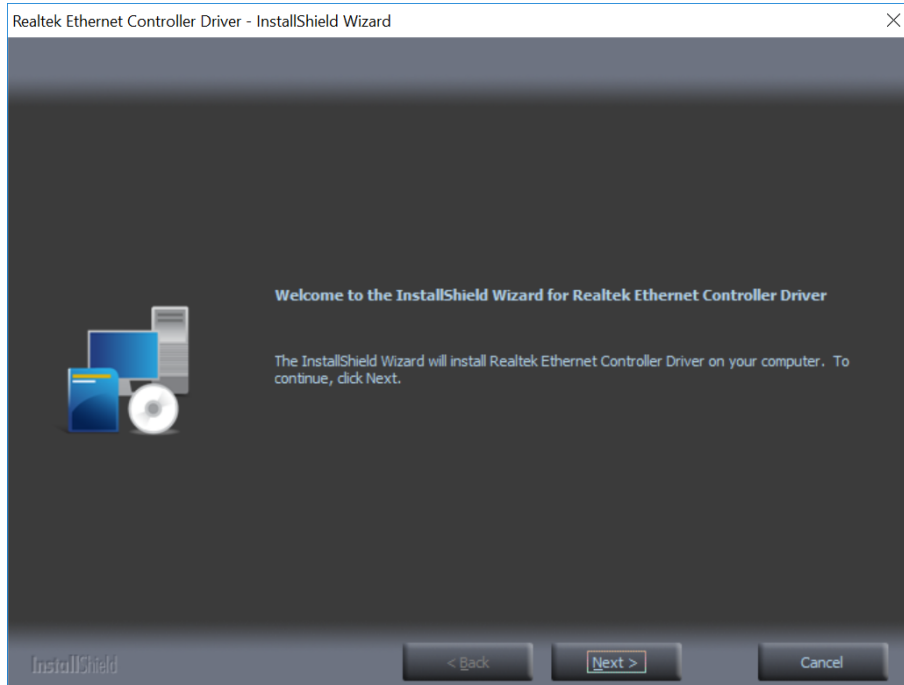

3. Accept the license agreement and click **Next** to continue.

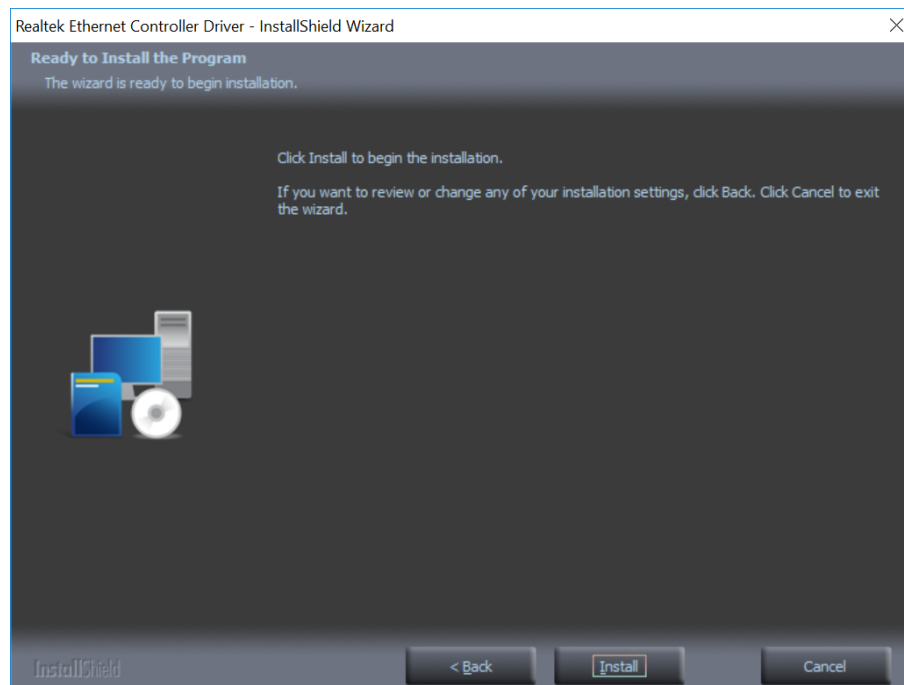

4. When the driver is completely installed, restart the computer for changes to take effect.

Chapter 4

BIOS Setup

This chapter describes the different settings available in the AMI BIOS that comes with the board. The topics covered in this chapter are as follows:

- Main Settings
- Advanced Settings
- Chipset Settings
- Security Settings
- Boot Settings
- Save & Exit

4.1 Introduction

The BIOS (Basic Input/Output System) installed in the ROM of your computer system supports Intel® processors. The BIOS provides critical low-level support for standard devices such as disk drives, serial ports and parallel ports. It also provides password protection as well as special support for detailed fine-tuning of the chipset controlling the entire system.

4.2 BIOS Setup

The BIOS provides a Setup utility program for specifying the system configurations and settings. The BIOS ROM of the system stores the Setup utility. When you turn on the computer, the BIOS is immediately activated. Press the key immediately allows you to enter the Setup utility. If you are a little bit late pressing the key, POST (Power On Self Test) will continue with its test routines, thus preventing you from invoking the Setup.

If you still need to enter Setup, restart the system by pressing the "Reset" button or simultaneously pressing the <Ctrl>, <Alt> and <Delete> keys. You can also restart by turning the system Off and back On again.

The following message will appear on the screen:

```
Press <DEL> to Enter Setup
```

In general, press the arrow keys to highlight items, <Enter> to select, the <PgUp> and <PgDn> keys to change entries, <F1> for help, and <Esc> to quit.

When you enter the BIOS Setup utility, the *Main Menu* screen will appear on the screen. The Main Menu allows you to select from various setup functions and exit choices.

Warning: It is strongly recommended that you avoid making any changes to the chipset defaults.

These defaults have been carefully chosen by both AMI and your system manufacturer to provide the absolute maximum performance and reliability. Changing the defaults could make the system unstable and crash in some cases.

4.3 Main Settings

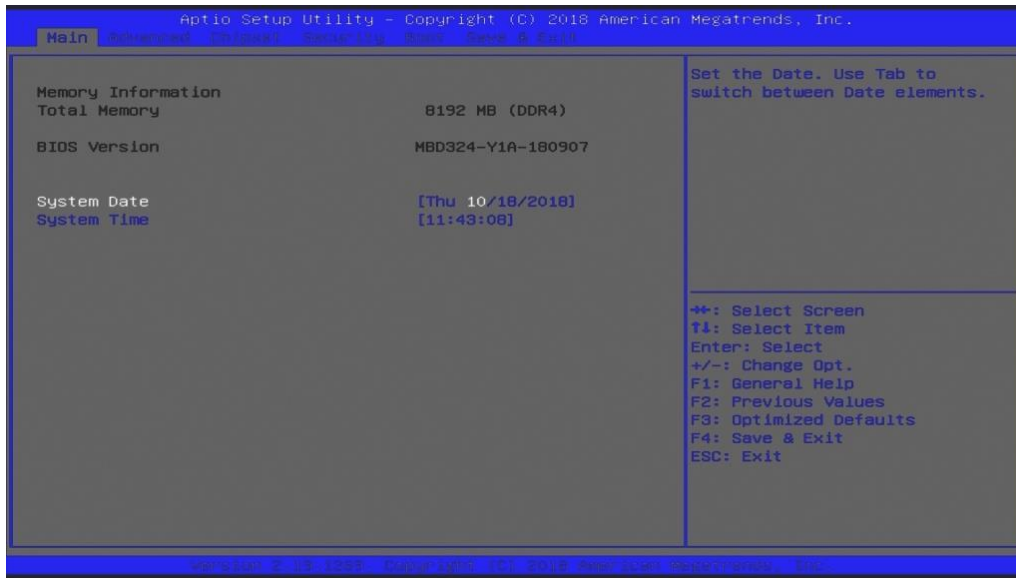

BIOS Setting	Description
System Date	Sets the date. Use the <Tab> key to switch between the date elements.
System Time	Set the time. Use the <Tab> key to switch between the time elements.

4.4 Advanced Settings

This section allows you to configure, improve your system and allows you to set up some system features according to your preference.

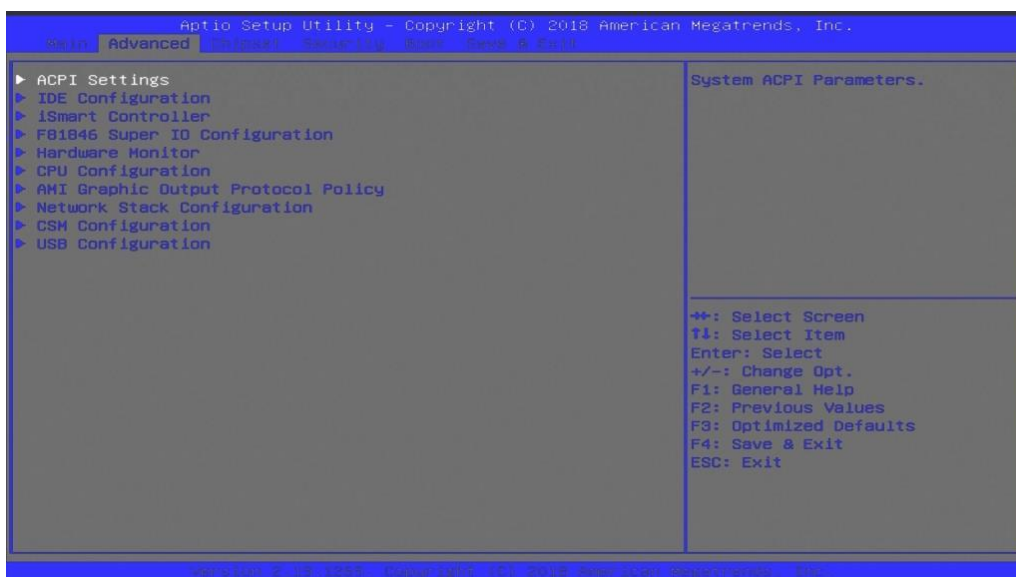

4.4.1 ACPI Settings

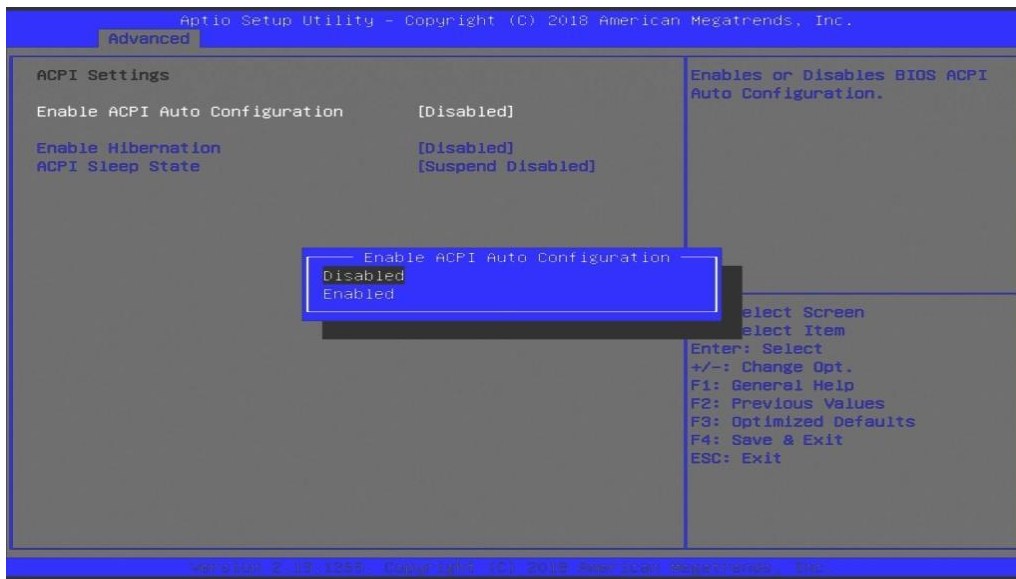

BIOS Setting	Description
Enable ACPI Auto Configuration	Enables / Disables BIOS ACPI auto configuration.
Enable Hibernation	Enables / Disables system ability to hibernate (OS/S4 Sleep State). This option may not be effective with some operating systems.
ACPI Sleep State	Selects the highest ACPI sleep state the system will enter when the SUSPEND button is pressed.

4.4.2 IDE Configuration

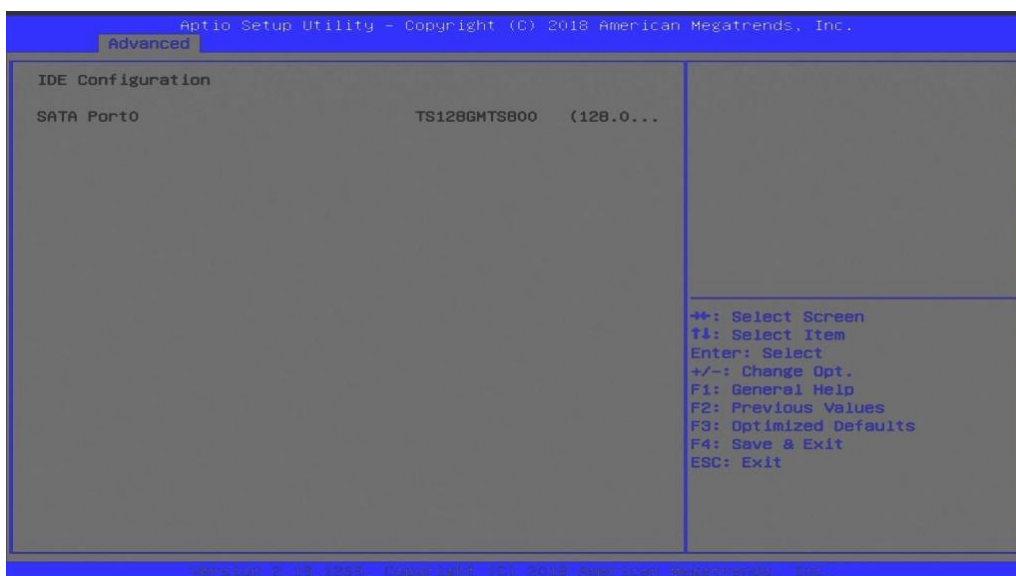

4.4.3 iSmart Controller

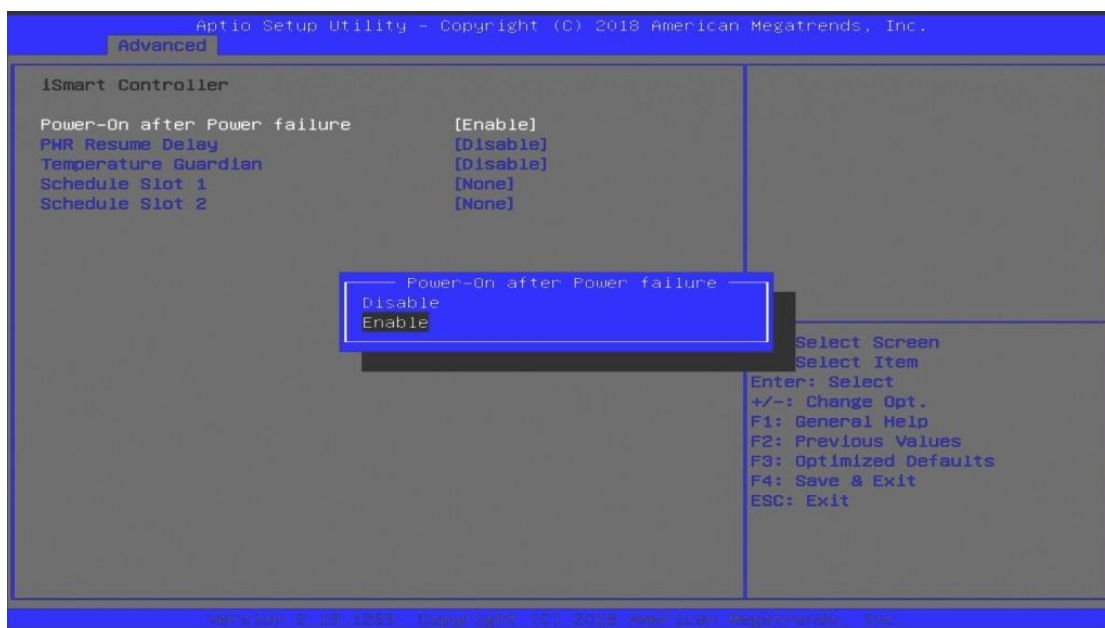

BIOS Setting	Description
Power-On after Power failure	Enables / Disables the system to be turned on automatically after a power failure.
PWR Resume Delay	Enables / Disables power on resume delay.
Temperature Guardian	Enables / Disables the temperature guardian.
Schedule Slot 1 / 2	<p>Sets up the hour / minute for system power-on.</p> <p>Important: If you would like to set up a schedule between adjacent days, configure two schedule slots.</p> <p>For example, if setting up a schedule from Wednesday 5 p.m. to Thursday 2 a.m., configure two schedule slots. But if setting up a schedule from 3 p.m to 5 p.m. on Wednesday, configure only a schedule slot.</p>

4.4.4 F81846 Super IO Configuration

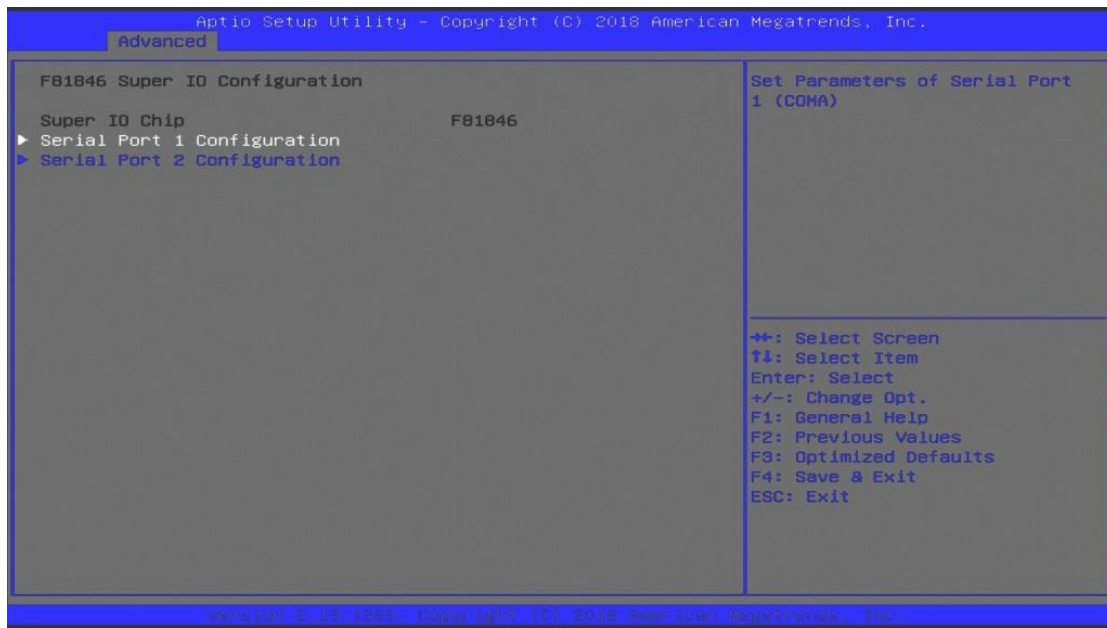

BIOS Setting	Description
Serial Ports Configuration	Sets parameters of Serial Port (COM). Enables / Disables the serial port and select an optimal setting for the Super IO device.

4.4.5 Hardware Monitor



BIOS Setting	Description
CPU Smart Fan Control	Disable or set fan control for CPU_FAN1 at 50°C, 60°C, 70°C or 80°C.
System Smart Fan Control	Disable or set fan control for CPU_FAN2 at 50°C, 60°C, 70°C or 80°C.
Temperatures / Voltages	These fields are the parameters of the hardware monitoring function feature of the motherboard. The values are read-only values as monitored by the system and show the PC health status.
CPU Shutdown Temperature	Disables or sets system shutdown temperature to 50°C, 60°C, 70°C or 80°C.

4.4.6 CPU Configuration



BIOS Setting	Description
Node 0 Information	Displays the memory information related to Node 0.

4.4.7 AMI Graphic Output Protocol Policy

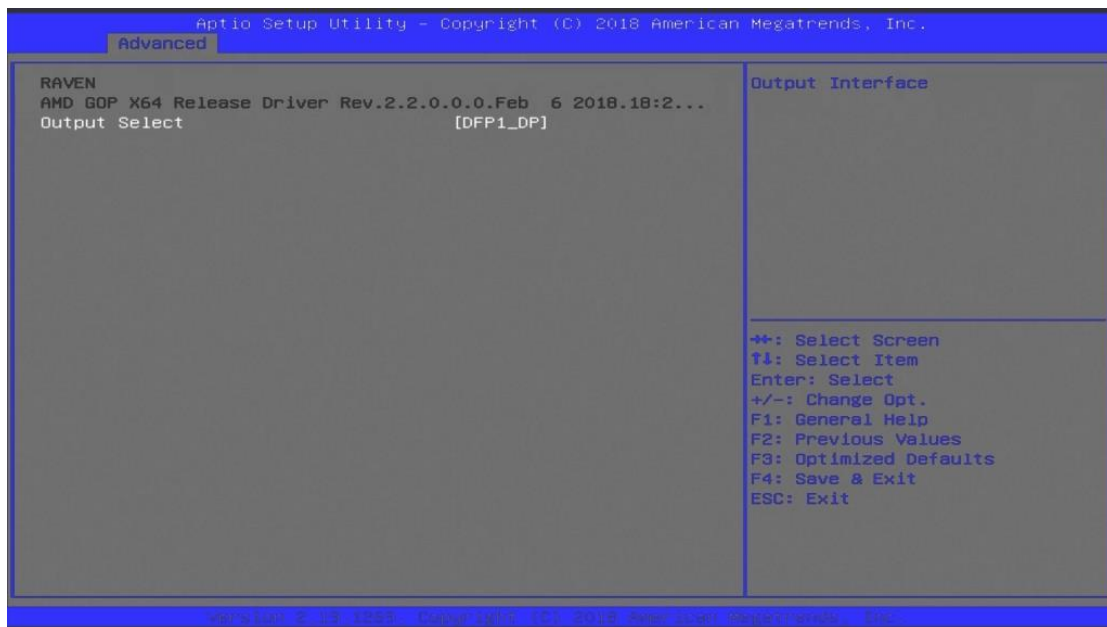

BIOS Setting	Description
Output Selection	Selects an output interface.

4.4.8 Network Stack Configuration

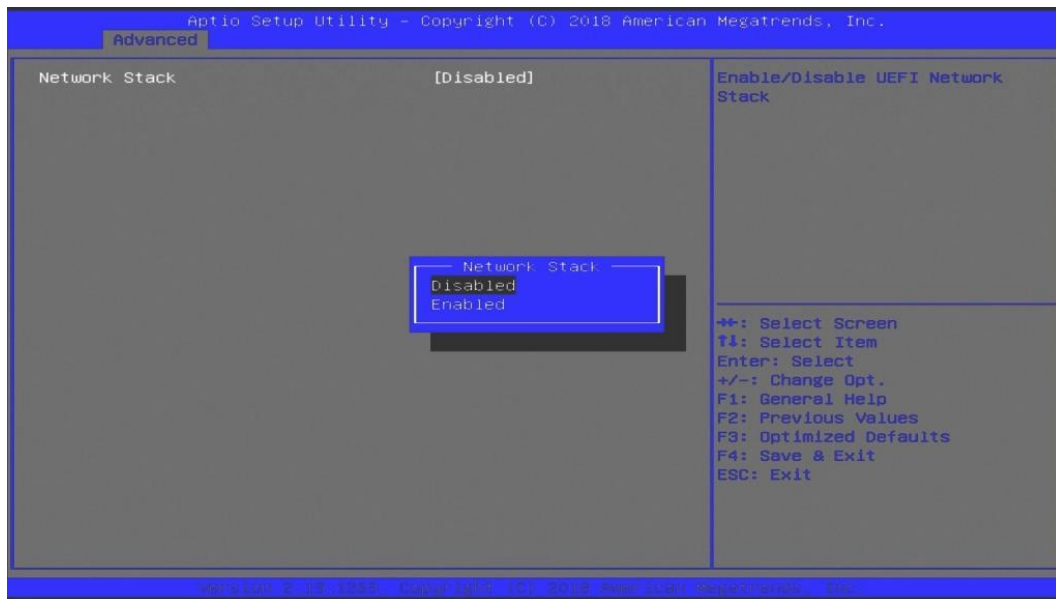

BIOS Setting	Description
Network Stack	Enables / Disables UEFI Network Stack.

4.4.9 CSM Configuration

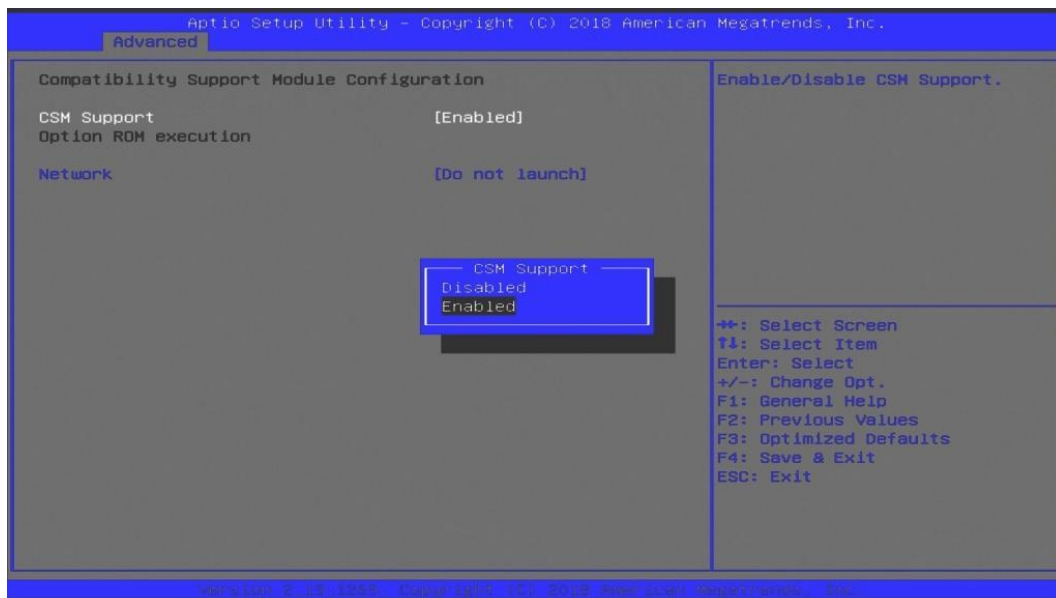

BIOS Setting	Description
CSM Support	Enables / Disables CSM support.
Network	Controls the execution of UEFI and Legacy PXE OpROM. Options: Do not launch, UEFI, Legacy

4.4.10 USB Configuration

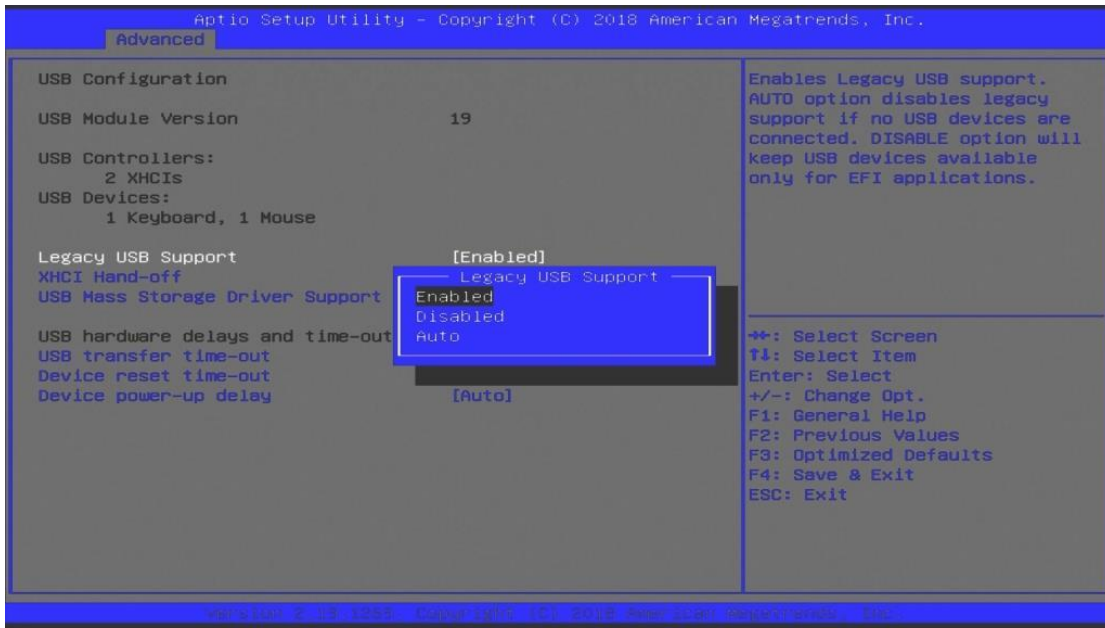

BIOS Setting	Description
Legacy USB Support	<ul style="list-style-type: none"> • Enable: Enables Legacy USB Support. • Auto: Disables legacy support if no USB devices are connected. • Disable: Keeps USB devices available only for EFI applications.
XHCI Hand-off	This is a workaround for OSES without XHCI hand-off support. The XHCI ownership change should be claimed by XHCI driver.
USB Mass Storage Driver Support	Enables / Disables the support for USB mass storage driver.
USB Transfer time-out	The time-out value for Control, Bulk, and Interrupt transfers.
Device reset time-out	Seconds of delaying execution of start unit command to USB mass storage device.
Device power-up delay	The maximum time the device will take before it properly reports itself to the Host Controller. "Auto" uses default value for a Root port it is 100ms. But for a Hub port, the delay is taken from Hub descriptor.

4.5 Chipset Settings

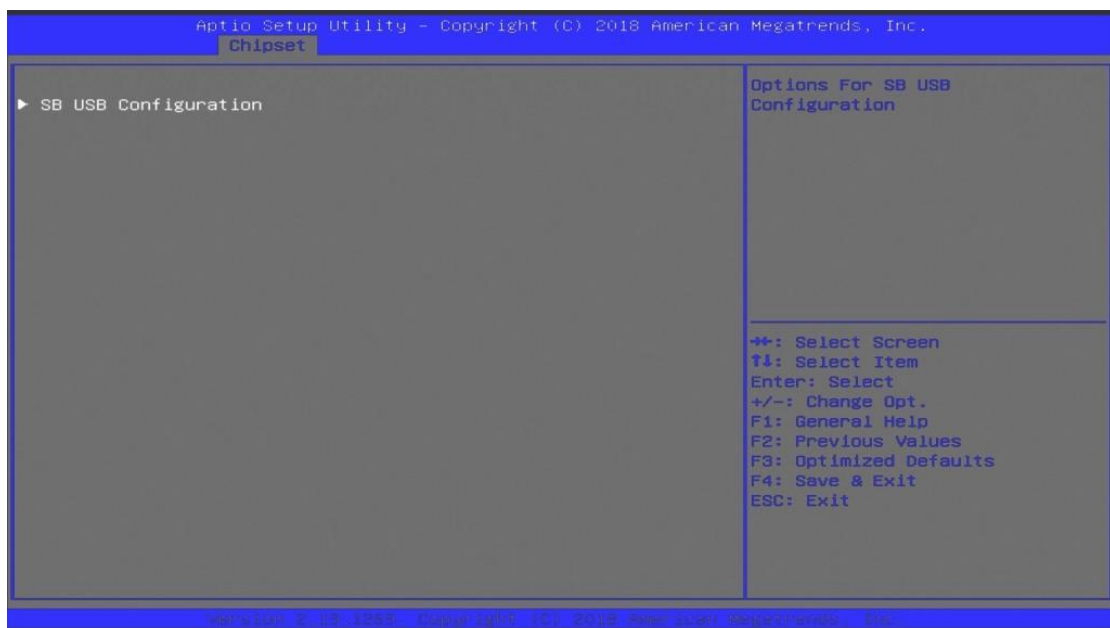

BIOS Setting	Description
South Bridge	South Bridge parameters
SB USB Configuration	Options for SB USB configuration.

4.5.1 SB USB Configuration

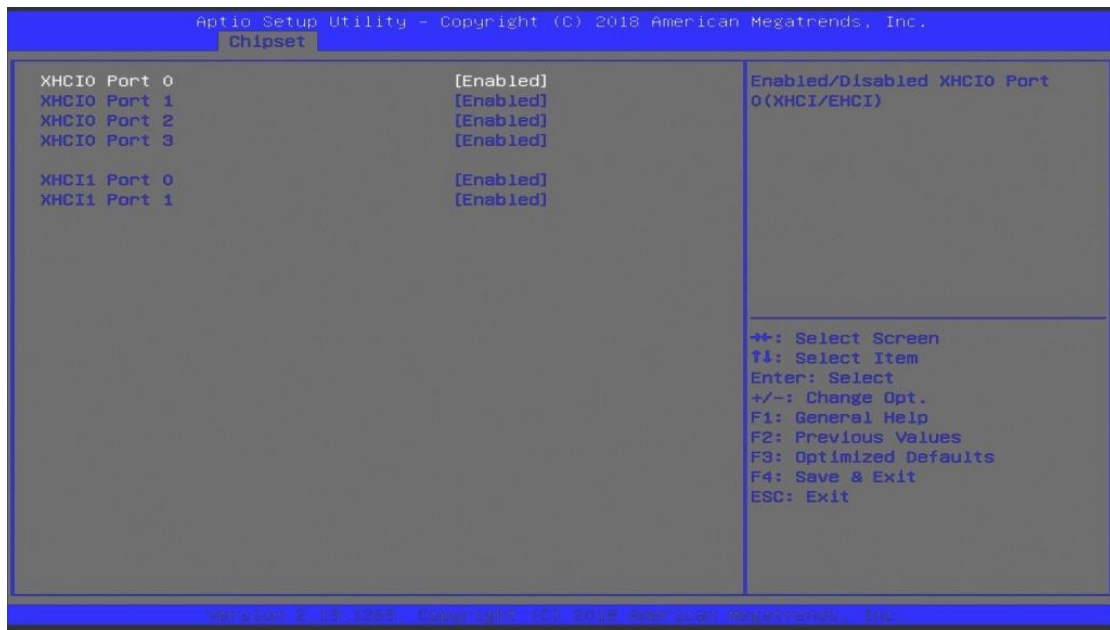

BIOS Setting	Description
XHCI0 / XHCI1 Ports	Enables / Disables XHCI0 / XHCI1 ports.

4.6 Security Settings

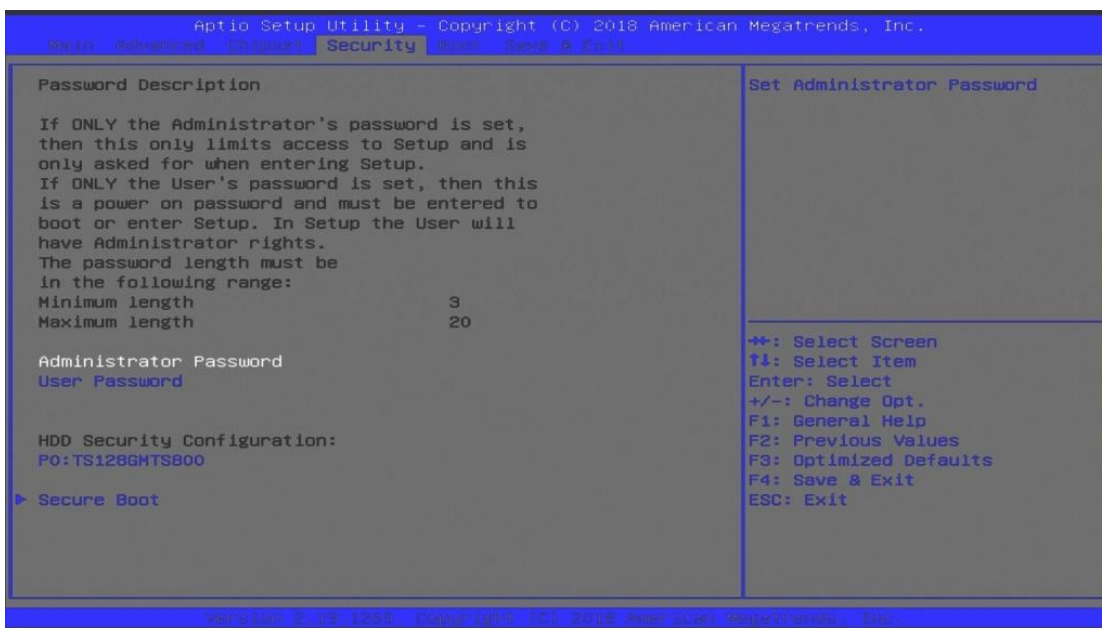

BIOS Setting	Description
Administrator Password	Sets an administrator password for the setup utility.
User Password	Sets a user password.
Secure Boot	Customizable secure boot settings.

4.6.1 Secure Boot Configuration

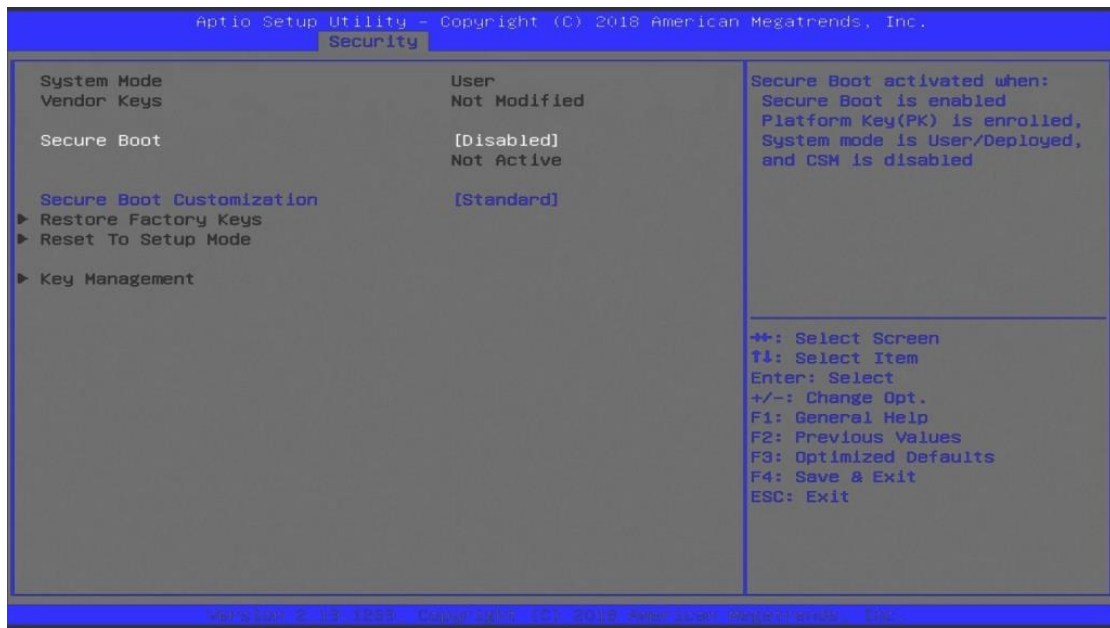

BIOS Setting	Description
Secure Boot	Secure Boot is activated when it is enabled, when the Platform Key (PK) is enrolled, the System mode is user deployed, and CSM is disabled.
Secure Boot Customization	Customizable Secure Boot mode: In Custom mode, Secure Boot policy variables can be configured by a physically present user without full authentication. Options: Standard, Custom

4.7 Boot Settings

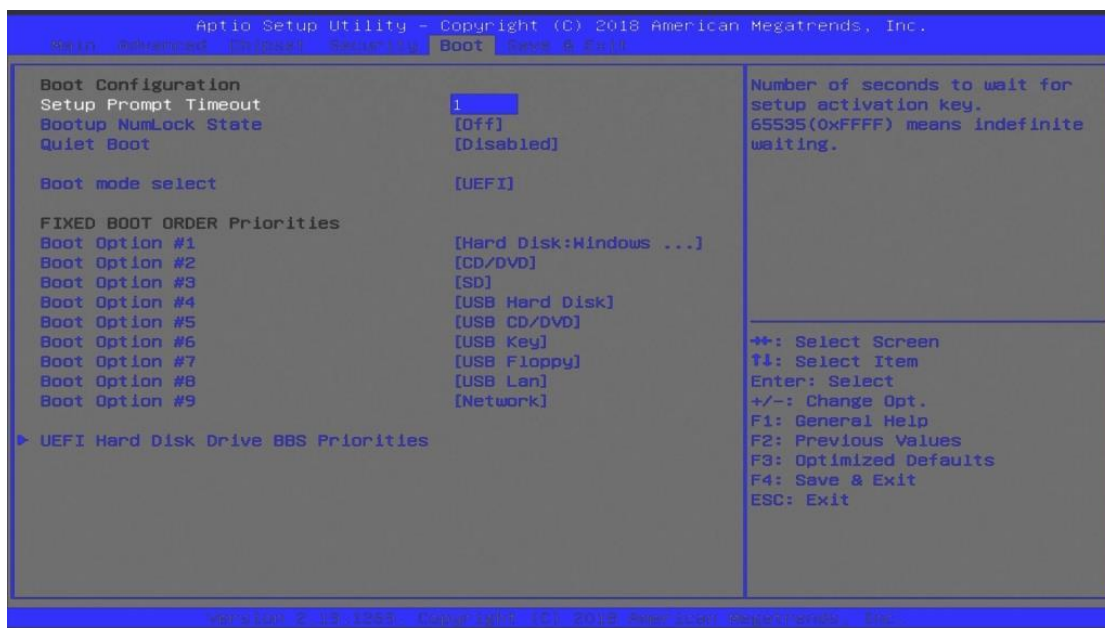

BIOS Setting	Description
Setup Prompt Timeout	Number of seconds to wait for setup activation key. 65535 (0xFFFF) means indefinite waiting.
Bootup NumLock State	Selects the keyboard NumLock state.
Quiet Boot	Enables / Disables Quiet Boot option.
Boot Mode Select	Select boot mode as Legacy or UEFI.
Boot Option Priorities	Sets the system boot order.
UEFI Hard Disk Drive BBS Priorities	Specifies the Boot device priority sequence from available UEFI hard disk drives.

4.8 Save & Exit Settings



BIOS Setting	Description
Save Changes and Exit	Exits system setup after saving the changes.
Discard Changes and Exit	Exits system setup without saving any changes.
Save Changes and Reset	Resets the system after saving the changes.
Discard Changes and Reset	Resets system setup without saving any changes.
Save Changes	Saves changes done so far to any of the setup options.
Discard Changes	Discards changes done so far to any of the setup options.
Restore Defaults	Restores / Loads defaults values for all the setup options.
Save as User Defaults	Saves the changes done so far as user defaults.
Restore User Defaults	Restores the user defaults to all the setup options.

Appendix

This section provides the mapping addresses of peripheral devices and the sample code of watchdog timer configuration.

- SDR and HDR Resolution Support
- AMD Eyefinity Multiple Displays
- I/O Port Address Map
- Interrupt Request Lines (IRQ)
- Watchdog Timer Configuration

A. SDR and HDR Resolution Support

A.1 Maximum SDR Resolution (Clone/Extended mode)

Dual Channel:

- 1 display: 2880p60 / 4320p30
- 2 displays: 2880p60 / 4320p30
- 3 displays: 2160p60
- 4 displays: 2160p60

Single Channel:

- 1 display: 2880p60 / 4320p30
- 2 displays: 2160p60
- 3 displays: 1440p60 / 2160p30
- 4 displays: 1440p60 / 2160p30

A.2 Maximum HDR Resolution (Clone/Extended mode)

Dual Channel:

- 2 displays: 2160p60
- 4 displays: 1440p60

Single Channel:

- 1 display: 2160p60
- 2 displays: 1440p60
- 4 displays: 1080p60

Note: This is about the supported display resolution, not related to the multimedia streams.

B. AMD Eyefinity Multiple Displays Configuration

AMD Eyefinity is applicable to SI-61S; it is a technology that allows two or more displays to be grouped together to form a single large desktop. Once AMD Eyefinity is configured, the final resolution is the horizontal and/or vertical sum of the individual monitors.

The following AMD embedded configurations are used for the demonstration of AMD Eyefinity configuration in this section.

Platform: AMD Embedded V1000 Reference Platform

APU: AMD Embedded V1000 Processor with AMD Radeon Vega Graphics

AMD Driver: 17.40.3775.1003.180508a-328988C-AES

B.1 Setting Up AMD Eyefinity Using Quick Setup

B.1.1 AMD Eyefinity Quick Setup with All Displays

This section describes how to set up AMD Eyefinity with the Quick Setup option, where all the connected displays will be part of the AMD Eyefinity Display Group created.

As AMD Eyefinity Quick Setup creates an Eyefinity Display Group based on the current (default) display configuration, ensure that the displays are arranged in the desired supported order first under extended desktop in the Operating System's display settings.

In the below example, Eyefinity Quick Setup is used to create a 3x1 AMD Eyefinity Display Group. So, arrange the displays in a 3x1 configuration in extended desktop before configuring AMD Eyefinity with Quick Setup.

To set up AMD Eyefinity with Quick Setup:

1. Open AMD Radeon Settings: Right-click on the desktop and select **AMD Radeon Settings**.

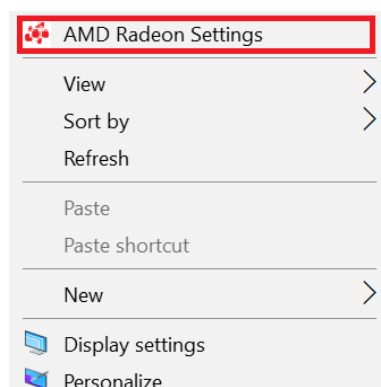

2. Click **Eyefinity** once **AMD Radeon Settings** opens.

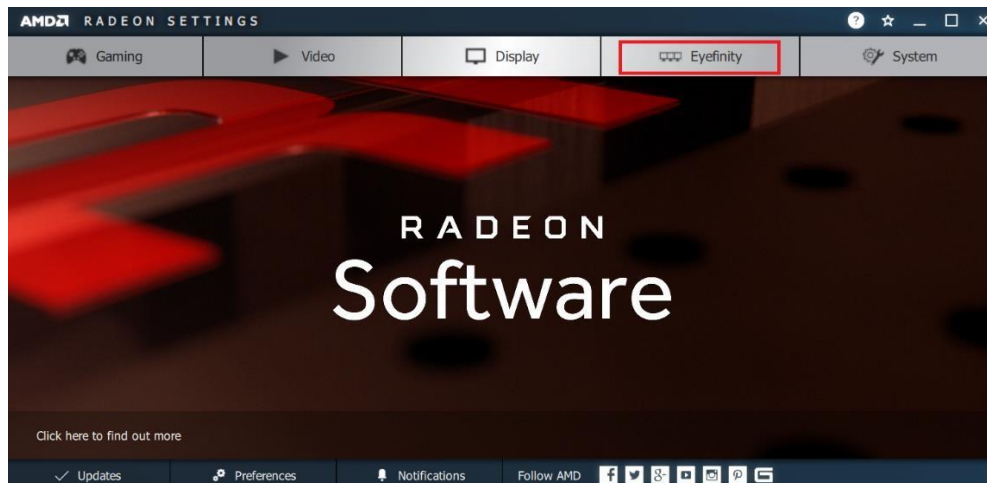

3. Click **Quick Setup** to automatically create an AMD Eyefinity Display Group based on the current (default) display configuration.

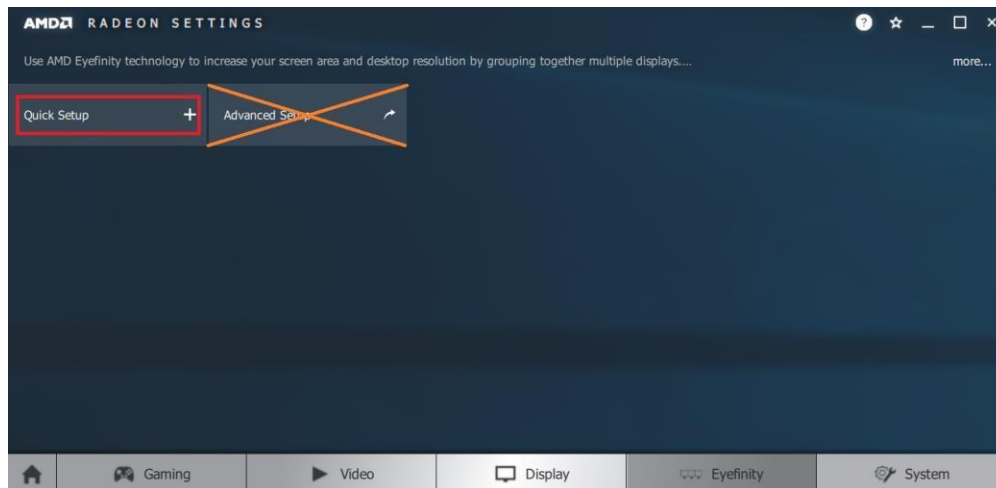

Note: At the time of writing, **Advanced Setup** for configuring Eyefinity is available. However, this feature is not supported. Do not confuse with **Try Advanced Setup** (see below picture), which becomes available after Eyefinity Quick Setup is complete. The **Try Advanced Setup** option is used to customize the Eyefinity Display Group created after Eyefinity Quick Setup is complete.

4. In this example, a 3x1 Eyefinity Display Group is created as shown below.

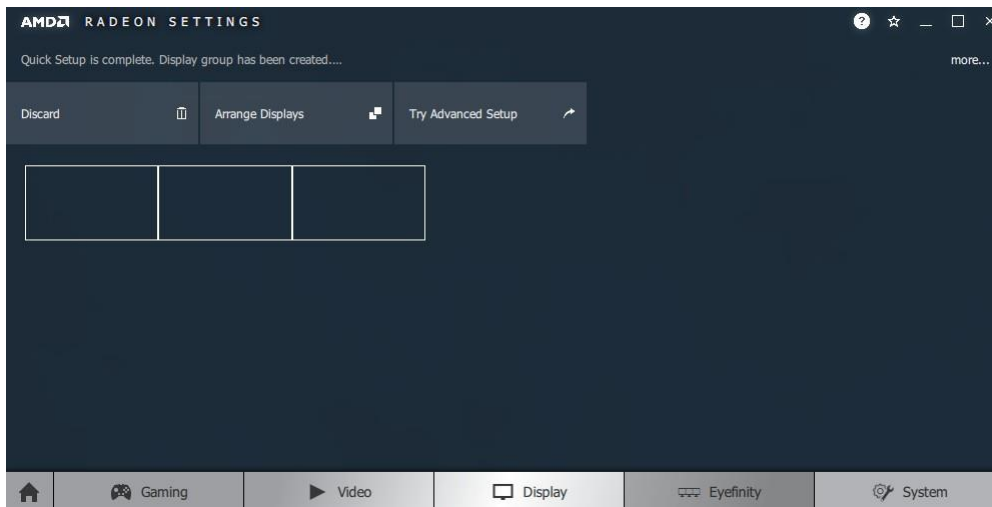

5. Once the AMD Eyefinity Display Group is created, the following options become available:
- **Discard** – Removes the AMD Eyefinity setup and restores the previous display configuration.
 - **Arrange Displays** – Arrange the position of each display in the AMD Eyefinity Display Group. Refer to the next section *Arrange Displays after Eyefinity Quick Setup* for details.
 - **Try Advanced Setup** – Additional settings to customize the AMD Eyefinity Display Group. Refer to *B.2 Customizing AMD Eyefinity Using Try Advanced Setup* for details.

Arrange Displays after Eyefinity Quick Setup

To arrange displays in desired positions (optional):

1. Click **Arrange Displays** after Eyefinity Quick Setup is complete.

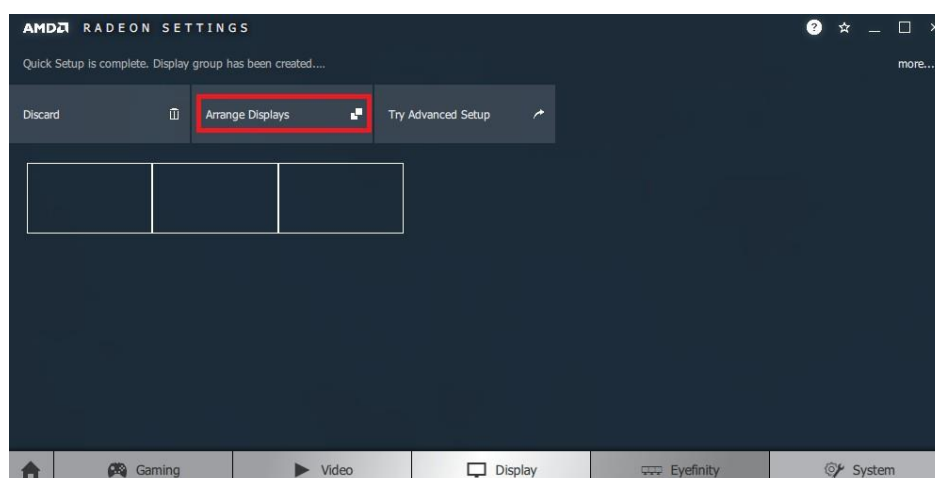

2. The onscreen guide will show a grid representation of the Eyefinity Display Group and one of the physical displays will have a blue background.



3. Click on the box in the grid that matches the desired location of the highlighted display in blue.

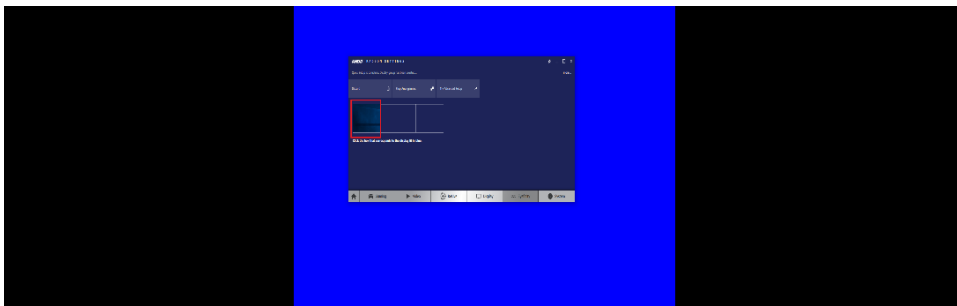

4. Repeat Step #3 with the rest of displays to complete the **Arrange Displays** setup.

B.1.2 AMD Eyefinity Quick Setup with Part of All Displays

As mentioned previously, since Eyefinity Quick Setup uses the current (default) display configuration which involves all the connected displays, configuring Eyefinity with only a portion of the connected displays is not allowed.

For example, setting up 3 x 1 Eyefinity with 4 connected displays is not possible with Eyefinity Quick Setup.

The following example, which sets up 3 x 1 Eyefinity (Quick Setup) with a total of 4 x 4k connected displays, demonstrates the method to work around the limitation:

1. Physically connect the displays to be used for the Eyefinity Display Group. In this setup, the number of displays for Eyefinity should be less than the total number of displays to be used in the overall setup (i.e. Eyefinity Display Group + Extended Desktop Displays).

In this example, physically connect 3 of the 4 displays first and arrange them in 3 x 1 extended desktop in the Operating System's display settings.

2. Follow the steps in Section 2.1, “AMD Eyefinity Quick Setup with All Displays” to configure Eyefinity.

In this example, a 3 x 1 Eyefinity Display Group has been created with 3 x 4k displays after Eyefinity Quick Setup is complete.

3. Once the 3 x 1 Eyefinity Display Group is created, connect (hotplug) the fourth display to the AMD graphics device.

The resulting setup consists of a 3 x 1 Eyefinity Display Group (11520 x 2160 resolution) + 1 x 4k (3840 x 2160 resolution) (in extended desktop).

B.2 Customizing AMD Eyefinity Using Try Advanced Setup

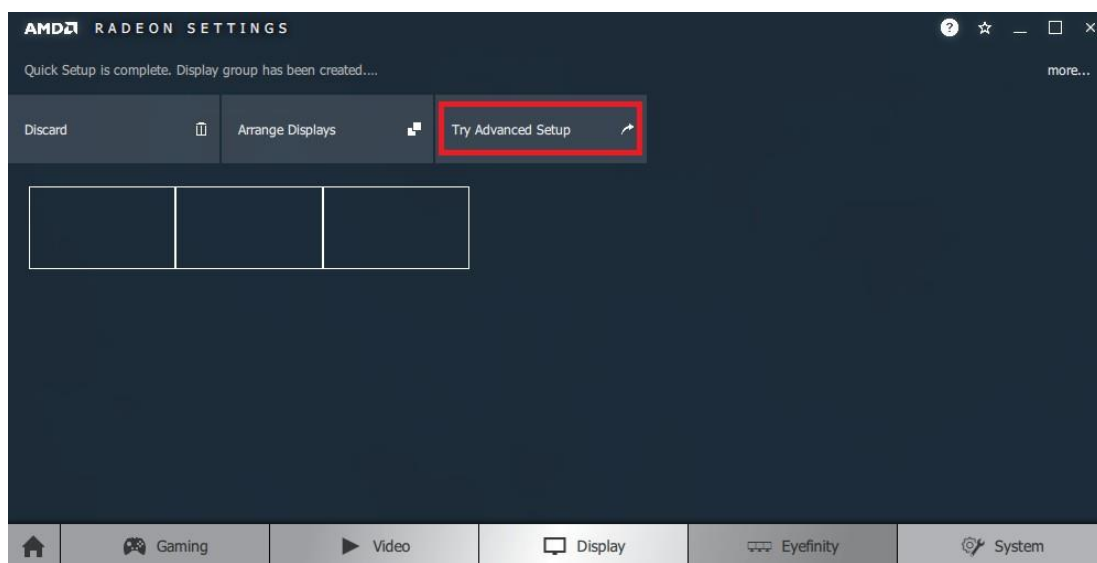

Try Advanced Setup becomes available after Eyefinity Quick Setup is complete (see above picture). It offers customization for the Eyefinity Display Group created, with options such as:

- Position Windows Taskbar
- Arrange Eyefinity Display Group
- Resize Desktop
- Disable Eyefinity Display Group
- Adjust Bezel Compensation
- Customize Eyefinity Desktop Resolution

B.2.1 Position Windows Taskbar

The **Position Windows Taskbar** option allows adjusting the Taskbar across all displays in the Eyefinity Display Group or in one preferred display. By default, the Taskbar extends across all displays in a single row AMD Eyefinity Display Group. In a multi-row AMD Eyefinity Display Group, it extends across the bottom row of displays.

To set the Taskbar position:

1. Click **Try Advanced Setup** (under **Eyefinity** tab in AMD Radeon Settings) after Eyefinity Quick Setup is complete.
2. Click **Position Windows Taskbar** once Radeon Additional Settings launches.
3. Check the **Position the Windows taskbar on a single display** option and click **Continue**.

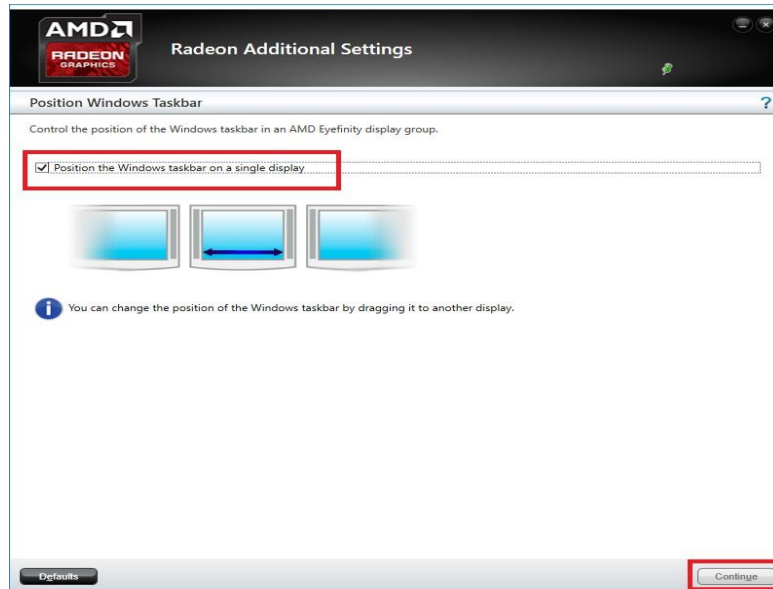

4. To move the Taskbar, simply drag and drop it to the desired display. Ensure that the Taskbar setting is not set to "locked".
5. To have the Taskbar running across multiple displays again, uncheck the **Position the Windows taskbar on a single display** option and click **Continue**.



B.2.2 Arrange Eyefinity Display Group

The **Arrange Eyefinity Display Group** option allows re-arranging the order of the displays in an AMD Eyefinity Display Group if needed.

To re-arrange the displays in an Eyefinity Display Group:

1. Click **Try Advanced Setup** (under **Eyefinity** tab in AMD Radeon Settings) after Eyefinity Quick Setup is complete.
2. Click **Arrange Eyefinity Display Group** once Radeon Additional Settings launches.
3. Use the same method as described in Section 2.1.1, “Arrange Displays after Eyefinity Quick Setup” (Step #2 to #4) to complete re-arranging the displays in an Eyefinity Display Group.

B.2.3 Resize Desktop

When displays in an AMD Eyefinity Display Group are configured to use different resolutions, rotations, or alignments, the desktop image may appear stretched or cropped. In an AMD Eyefinity Group consisting of displays with mixed dimensions (different sizes, resolutions, orientations), the **Resize Desktop** option changes how the desktop image is shown across the displays by resizing it.

To resize the desktop:

1. Click **Try Advanced Setup** (under **Eyefinity** tab in AMD Radeon Settings) after Eyefinity Quick Setup is complete.
2. Click **Resize Desktop** once Radeon Additional Settings launches.

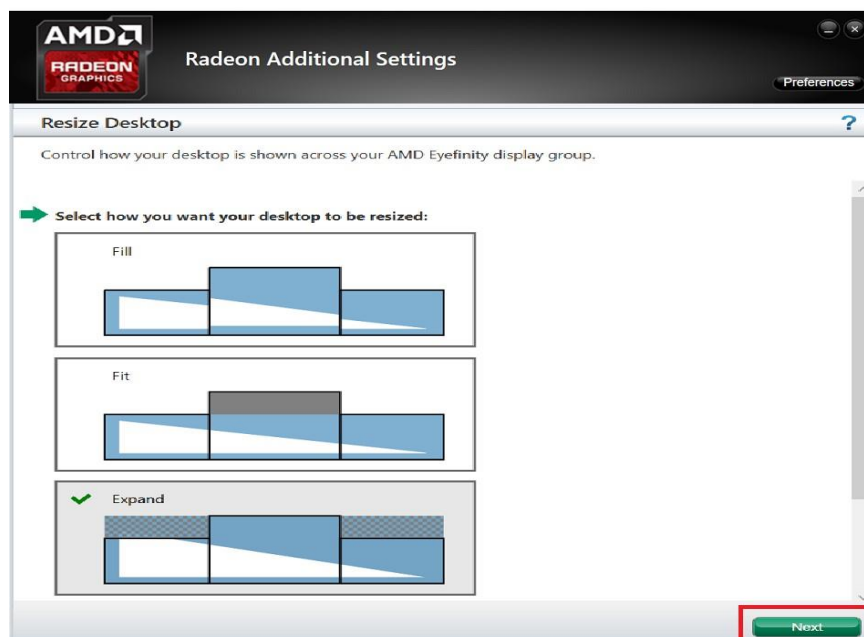

3. Choose one of the following options:
 - **Fill** - Fill the entire area of each display with its portion of the desktop. The desktop may appear stretched on certain displays.
 - **Fit** - Resize the desktop to the height of the shortest display. Show the entire desktop across all displays without cropping or stretching the desktop. Certain areas of your displays may appear blank.
 - **Expand** - Resize the desktop to the height of the tallest display. Portions of the desktop, for example, the Taskbar, may appear cropped or missing on certain displays.
4. Click **Next** to complete and save the setup.

B.2.4 Disable Eyefinity Display Group

The **Disable Eyefinity Display Group** option disables an already configured Eyefinity Display Group to return all displays in the group to the original display configuration.

To disable the Eyefinity Display Group:

1. Click **Try Advanced Setup** (under **Eyefinity** tab in AMD Radeon Settings) after Eyefinity Quick Setup is complete.
2. Click **Disable Eyefinity Display Group** once Radeon Additional Settings launches.

B.2.5 Adjust Bezel Compensation

In an AMD Eyefinity Display Group the edges (bezels) of the displays may cause the image to appear disjointed or not continuous. The **Adjust Bezel Compensation** feature provides alignment functions that allow the desktop to appear continuous across all displays in an Eyefinity Display Group.

To adjust bezel compensation:

1. Click **Try Advanced Setup** (under **Eyefinity** tab in AMD Radeon Settings) after Eyefinity Quick Setup is complete.
2. Click **Adjust Bezel Compensation** once Radeon Additional Settings launches.
3. Use the Chevrons (arrow heads) to move the triangle test pattern until it is properly aligned (as shown in below picture).

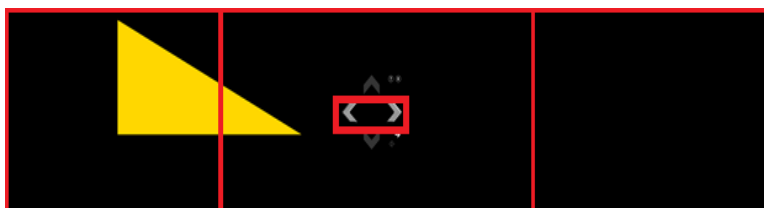

- Click on the directional arrow:



Then click **No** for the “Are the test patterns correct?” box to repeat Step #3 for the next set of bezels.

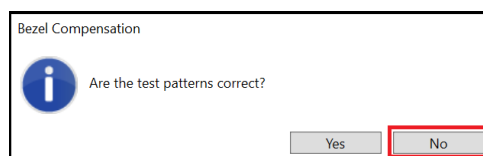

- When complete, click the **X** button and Yes to save the changes and close the tool.

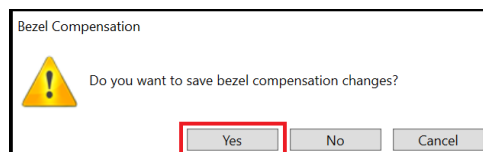

B.2.6 Customize Eyefinity Desktop Resolution

The **Customize Eyefinity Desktop Resolution** option allows the desktop size of an AMD Eyefinity Display Group to be changed to any resolution that is listed in the Custom Resolution drop-down menu. Once the desired Custom Resolution is chosen in **Customize Eyefinity Desktop Resolution**, this particular resolution becomes available in the Operating System’s display settings menu for selection.

To customize Eyefinity desktop resolution:

- Click **Try Advanced Setup** (under **Eyefinity** tab in AMD Radeon Settings) after Eyefinity Quick Setup is complete.
- Click **Customize Eyefinity Desktop Resolution** once Radeon Additional Settings launches.

iBASE

3. In the **Customize Eyefinity Desktop Resolution** menu, the minimum and maximum resolutions are automatically determined based on your displays and cannot be changed. Use the **Custom Resolution** drop-down menu to select from a list of supported resolutions.

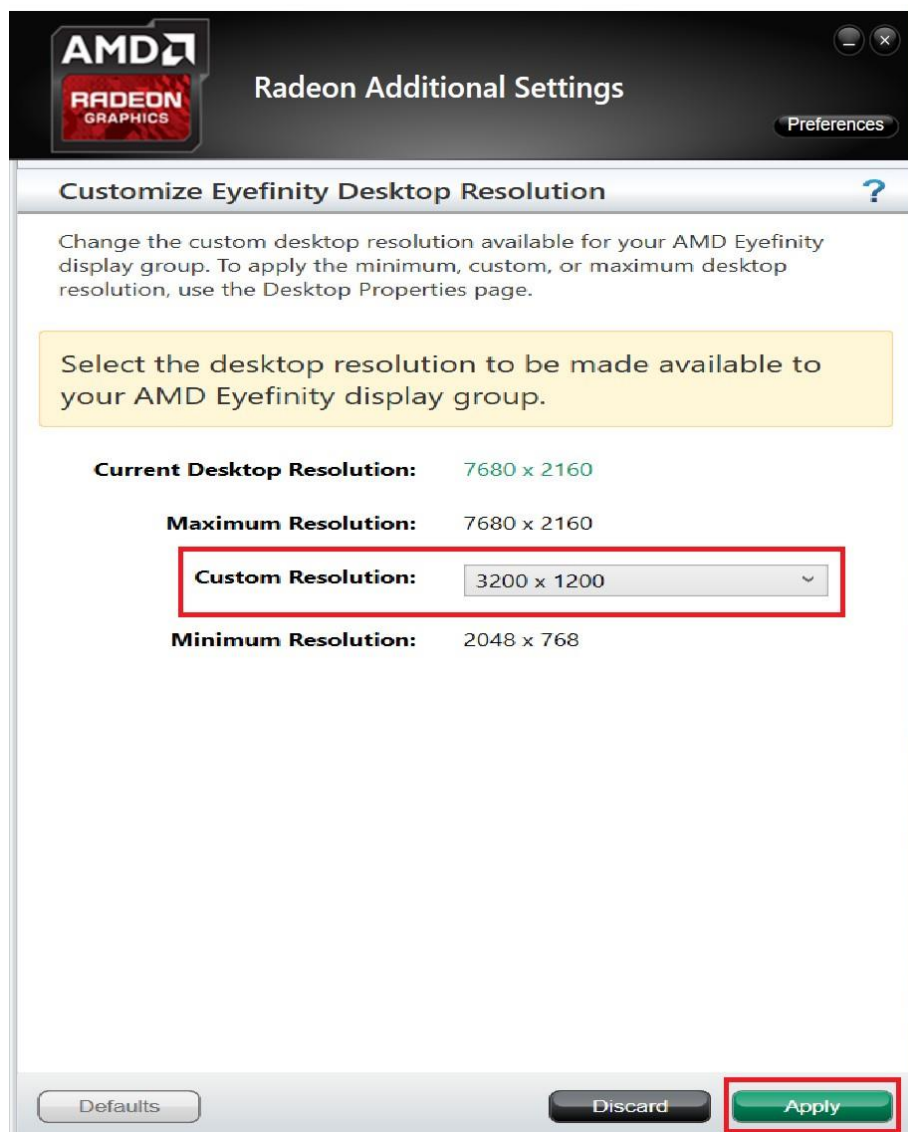

4. Select the preferred resolution from the **Custom Resolution** drop-down menu, and click **Apply** to save the setting.
5. Open the Operating System's display settings menu to change the resolution to the Custom Resolution selected in Step #4.

C. I/O Port Address Map

Each peripheral device in the system is assigned a set of I/O port addresses which also becomes the identity of the device. The following table lists the I/O port addresses used.

Address	Device Description
0x00000A00-0x00000A0F	Motherboard resources
0x00000A10-0x00000A1F	Motherboard resources
0x00000A10-0x00000A1F	Motherboard resources
0x00000070-0x00000071	System CMOS/real time clock
0x0000D000-0x0000DFFF	PCI Express Root Port
0x0000D000-0x0000DFFF	AMD Radeon(TM) Vega 11 Graphics
0x000003F8-0x000003FF	Communications Port (COM1)
0x000002F8-0x000002FF	Communications Port (COM2)
0x00000020-0x00000021	Programmable interrupt controller
0x000000A0-0x000000A1	Programmable interrupt controller
0x00000000-0x000003AF	PCI Express Root Complex
0x00000000-0x000003AF	Direct memory access controller
0x000003E0-0x00000CF7	PCI Express Root Complex
0x000003B0-0x000003DF	PCI Express Root Complex
0x00000D00-0x0000FFFF	PCI Express Root Complex
0x0000F000-0x0000F0FF	Realtek PCIe GBE Family Controller #2
0x0000F000-0x0000F0FF	PCI Express Root Port
0x0000E000-0x0000EFFF	PCI Express Root Port
0x0000E000-0x0000EFFF	Realtek PCIe GBE Family Controller
0x00000040-0x00000043	System timer
0x00000010-0x0000001F	Motherboard resources
0x00000022-0x0000003F	Motherboard resources
0x00000063-0x00000063	Motherboard resources
0x00000065-0x00000065	Motherboard resources
0x00000067-0x0000006F	Motherboard resources
0x00000072-0x0000007F	Motherboard resources
0x00000080-0x00000080	Motherboard resources
0x00000084-0x00000086	Motherboard resources

Address	Device Description
0x00000088-0x00000088	Motherboard resources
0x0000008C-0x0000008E	Motherboard resources
0x00000090-0x0000009F	Motherboard resources
0x000000A2-0x000000BF	Motherboard resources
0x000000B1-0x000000B1	Motherboard resources
0x000000E0-0x000000EF	Motherboard resources
0x000004D0-0x000004D1	Motherboard resources
0x0000040B-0x0000040B	Motherboard resources
0x000004D6-0x000004D6	Motherboard resources
0x00000C00-0x00000C01	Motherboard resources
0x00000C14-0x00000C14	Motherboard resources
0x00000C50-0x00000C51	Motherboard resources
0x00000C52-0x00000C52	Motherboard resources
0x00000C6C-0x00000C6C	Motherboard resources
0x00000C6F-0x00000C6F	Motherboard resources
0x00000CD0-0x00000CD1	Motherboard resources
0x00000CD2-0x00000CD3	Motherboard resources
0x00000CD4-0x00000CD5	Motherboard resources
0x00000CD6-0x00000CD7	Motherboard resources
0x00000CD8-0x00000CDF	Motherboard resources
0x00000800-0x0000089F	Motherboard resources
0x00000B00-0x00000B0F	Motherboard resources
0x00000B20-0x00000B3F	Motherboard resources
0x00000900-0x0000090F	Motherboard resources
0x00000910-0x0000091F	Motherboard resources
0x00000061-0x00000061	System speaker
0x00000081-0x00000083	Direct memory access controller
0x00000087-0x00000087	Direct memory access controller
0x00000089-0x0000008B	Direct memory access controller
0x0000008F-0x0000008F	Direct memory access controller
0x000000C0-0x000000DF	Direct memory access controller

D. Interrupt Request Lines (IRQ)

Peripheral devices use interrupt request lines to notify CPU for the service required. The following table shows the IRQ used by the devices on board.

Level	Function
IRQ 4294967292	PCI Express Root Port
IRQ 0	High precision event timer
IRQ 0	System timer
IRQ 8	High precision event timer
IRQ 7	AMD GPIO Controller
IRQ 4294967282	AMD USB 3.10 eXtensible Host Controller - 1.10 (Microsoft)
IRQ 4294967281	AMD USB 3.10 eXtensible Host Controller - 1.10 (Microsoft)
IRQ 4294967280	AMD USB 3.10 eXtensible Host Controller - 1.10 (Microsoft)
IRQ 4294967279	AMD USB 3.10 eXtensible Host Controller - 1.10 (Microsoft)
IRQ 4294967278	AMD USB 3.10 eXtensible Host Controller - 1.10 (Microsoft)
IRQ 4294967277	AMD USB 3.10 eXtensible Host Controller - 1.10 (Microsoft)
IRQ 4294967276	AMD USB 3.10 eXtensible Host Controller - 1.10 (Microsoft)
IRQ 4294967275	AMD USB 3.10 eXtensible Host Controller - 1.10 (Microsoft)
IRQ 4	Communications Port (COM1)
IRQ 3	Communications Port (COM2)
IRQ 53	High Definition Audio Controller
IRQ 53	AMD Audio CoProcessor
IRQ 54	AMD High Definition Audio Controller
IRQ 54	Microsoft ACPI-Compliant System
IRQ 4294967285	AMD Radeon(TM) Vega 11 Graphics
IRQ 4294967284	AMD Radeon(TM) Vega 11 Graphics
IRQ 4294967283	AMD Radeon(TM) Vega 11 Graphics
IRQ 55	Microsoft ACPI-Compliant System

Level	Function
IRQ 55	AMD SFH KMDf I2C
IRQ 56 ~ IRQ 204	Microsoft ACPI-Compliant System
IRQ 256 ~ IRQ 511	Microsoft ACPI-Compliant System
IRQ 4294967287	Realtek PCIe GBE Family Controller #2
IRQ 4294967294	PCI Express Root Port
IRQ 4294967293	PCI Express Root Port
IRQ 4294967291	PCI Express Root Port
IRQ 4294967290	Standard SATA AHCI Controller
IRQ 4294967286	Realtek PCIe GBE Family Controller
IRQ 4294967274	AMD USB 3.10 eXtensible Host Controller - 1.10 (Microsoft)
IRQ 4294967273	AMD USB 3.10 eXtensible Host Controller - 1.10 (Microsoft)
IRQ 4294967272	AMD USB 3.10 eXtensible Host Controller - 1.10 (Microsoft)
IRQ 4294967271	AMD USB 3.10 eXtensible Host Controller - 1.10 (Microsoft)
IRQ 4294967270	AMD USB 3.10 eXtensible Host Controller - 1.10 (Microsoft)
IRQ 4294967269	AMD USB 3.10 eXtensible Host Controller - 1.10 (Microsoft)
IRQ 4294967268	AMD USB 3.10 eXtensible Host Controller - 1.10 (Microsoft)
IRQ 4294967267	AMD USB 3.10 eXtensible Host Controller - 1.10 (Microsoft)
IRQ 4294967289	AMD PSP 10.0 Device
IRQ 4294967288	AMD PSP 10.0 Device

E. Watchdog Timer Configuration

The Watchdog Timer (WDT) is used to generate a variety of output signals after a user programmable count. The WDT is suitable for the use in the prevention of system lock-up, such as when software becomes trapped in a deadlock. Under these sorts of circumstances, the timer will count to zero and the selected outputs will be driven.

Under normal circumstance, you will need to restart the WDT at regular intervals before the timer counts to zero.

Sample Code:

```
//-----
//
// THIS CODE AND INFORMATION IS PROVIDED "AS IS" WITHOUT WARRANTY OF ANY
// KIND, EITHER EXPRESSED OR IMPLIED, INCLUDING BUT NOT LIMITED TO THE
// IMPLIED WARRANTIES OF MERCHANTABILITY AND/OR FITNESS FOR A PARTICULAR
// PURPOSE.
//
//-----
#include <dos.h>
#include <conio.h>
#include <stdio.h>
#include <stdlib.h>
#include "F81846.H"
//-----
int main (int argc, char *argv[]); void EnableWDT(int);
void DisableWDT(void);
//-----
int main (int argc, char *argv[])
{
  unsigned char bBuf; unsigned char bTime; char **endptr;

  char SIO;
  printf("Fintek 81846 watch dog program\n"); SIO = Init_F81846();
  if (SIO == 0)
  {
    printf("Can not detect Fintek 81846, program abort.\n"); return(1);
  }/if (SIO == 0)

  if (argc != 2)
  {
    printf(" Parameter incorrect!!\n"); return (1);
  }

  bTime = strtol (argv[1], endptr, 10);
  printf("System will reset after %d seconds\n", bTime);

  if (bTime)
  {   EnableWDT(bTime); } else
  {   DisableWDT(); } return 0;
}
```

iBASE

```
}
//-----
void EnableWDT(int interval)
{
    unsigned char bBuf;

    bBuf = Get_F81846_Reg(0x2B); bBuf &= (~0x20);
    Set_F81846_Reg(0x2B, bBuf); //Enable WDTO

    Set_F81846_LD(0x07); //switch to logic device 7
    Set_F81846_Reg(0x30, 0x01); //enable timer

    bBuf = Get_F81846_Reg(0xF5); bBuf &= (~0x0F);
    bBuf |= 0x52;
    Set_F81846_Reg(0xF5, bBuf); //count mode is second Set_F81846_Reg(0xF6,
    interval); //set timer
    bBuf = Get_F81846_Reg(0xFA); bBuf |= 0x01;
    Set_F81846_Reg(0xFA, bBuf); //enable WDTO output

    bBuf = Get_F81846_Reg(0xF5); bBuf |= 0x20;
    Set_F81846_Reg(0xF5, bBuf); //start counting
}
//-----
void DisableWDT(void)
{
    unsigned char bBuf;
    Set_F81846_LD(0x07); //switch to logic device 7 bBuf = Get_F81846_Reg(0xFA);
    bBuf &= ~0x01;
    Set_F81846_Reg(0xFA, bBuf); //disable WDTO output

    bBuf = Get_F81846_Reg(0xF5); bBuf &= ~0x20;
    bBuf |= 0x40;
    Set_F81846_Reg(0xF5, bBuf); //disable WDT
}
//-----

//-----
//
// THIS CODE AND INFORMATION IS PROVIDED "AS IS" WITHOUT WARRANTY OF ANY
// KIND, EITHER EXPRESSED OR IMPLIED, INCLUDING BUT NOT LIMITED TO THE
// IMPLIED WARRANTIES OF MERCHANTABILITY AND/OR FITNESS FOR A PARTICULAR
// PURPOSE.
//
//-----
#include "F81846.H"
#include <dos.h>
//-----
unsigned int F81846_BASE; void Unlock_F81846 (void); void Lock_F81846 (void);
//-----
unsigned int Init_F81846(void)
{
    unsigned int result; unsigned char ucDid;
```

```

F81846_BASE = 0x4E;
result = F81846_BASE;

ucDid = Get_F81846_Reg(0x20);
if (ucDid == 0x07) //Fintek 81846
{   goto Init_Finish; }

F81846_BASE = 0x2E;
result = F81846_BASE;

ucDid = Get_F81846_Reg(0x20);
if (ucDid == 0x07) //Fintek 81846
{   goto Init_Finish; }

F81846_BASE = 0x00;
result = F81846_BASE;

Init_Finish:
return (result);
}
//-----
void Unlock_F81846 (void)
{
outportb(F81846_INDEX_PORT, F81846_UNLOCK); outportb(F81846_INDEX_PORT,
F81846_UNLOCK);
}
//-----
void Lock_F81846 (void)
{
outportb(F81846_INDEX_PORT, F81846_LOCK);
}
//-----
void Set_F81846_LD( unsigned char LD)
{
Unlock_F81846();
outportb(F81846_INDEX_PORT, F81846_REG_LD);
outportb(F81846_DATA_PORT, LD); Lock_F81846();
}
//-----
void Set_F81846_Reg( unsigned char REG, unsigned char DATA)
{
Unlock_F81846(); outportb(F81846_INDEX_PORT, REG); outportb(F81846_DATA_PORT,
DATA); Lock_F81846();
}
//-----
unsigned char Get_F81846_Reg(unsigned char REG)
{
unsigned char Result; Unlock_F81846();
outportb(F81846_INDEX_PORT, REG); Result = inportb(F81846_DATA_PORT);
Lock_F81846();
return Result;
}
//-----

```

```
//-----  
//  
// THIS CODE AND INFORMATION IS PROVIDED "AS IS" WITHOUT WARRANTY OF ANY  
// KIND, EITHER EXPRESSED OR IMPLIED, INCLUDING BUT NOT LIMITED TO THE  
// IMPLIED WARRANTIES OF MERCHANTABILITY AND/OR FITNESS FOR A PARTICULAR  
// PURPOSE.  
//  
//-----  
#ifndef F81846_H  
#define F81846_H 1  
//-----  
#define F81846_INDEX_PORT (F81846_BASE)  
#define F81846_DATA_PORT (F81846_BASE+1)  
//-----  
#define F81846_REG_LD 0x07  
//-----  
#define F81846_UNLOCK 0x87  
#define F81846_LOCK 0xAA  
//-----  
unsigned int Init_F81846(void);  
void Set_F81846_LD( unsigned char);  
void Set_F81846_Reg( unsigned char, unsigned char); unsigned char  
Get_F81846_Reg( unsigned char);  
//-----  
#endif // F81846_H
```