

# **MI979 Series**

**AMD Embedded R/G-Series SoC  
Mini-ITX Motherboard**

## **User's Manual**

Version 1.0  
(Oct. 2017)

## **Copyright**

© 2017 IBASE Technology, Inc. All rights reserved.

No part of this publication may be reproduced, copied, stored in a retrieval system, translated into any language or transmitted in any form or by any means, electronic, mechanical, photocopying, or otherwise, without the prior written consent of IBASE Technology, Inc. (hereinafter referred to as “IBASE”).

## **Disclaimer**

IBASE reserves the right to make changes and improvements to the products described in this document without prior notice. Every effort has been made to ensure the information in the document is correct; however, IBASE does not guarantee this document is error-free.

IBASE assumes no liability for incidental or consequential damages arising from misapplication or inability to use the product or the information contained herein, nor for any infringements of rights of third parties, which may result from its use.

## **Trademarks**

All the trademarks, registrations and brands mentioned herein are used for identification purposes only and may be trademarks and/or registered trademarks of their respective owners.

## Compliance



The product described in this manual complies with all applicable European Union (CE) directives if it has a CE marking. For systems to remain CE compliant, only CE-compliant parts may be used. Maintaining CE compliance also requires proper cable and cabling techniques.



This product has been tested and found to comply with the limits for a Class B device, pursuant to Part 15 of the FCC Rules. These limits are designed to provide reasonable protection against harmful interference in a residential installation. This equipment generates, uses and can radiate radio frequency energy and, if not installed and used in accordance with manufacturer's instructions, may cause harmful interference to radio communications.

### WEEE



This product must not be disposed of as normal household waste, in accordance with the EU directive of for waste electrical and electronic equipment (WEEE - 2012/19/EU). Instead, it should be disposed of by returning it to a municipal recycling collection point. Check local regulations for disposal of electronic products.

### Green IBASE



This product is compliant with the current RoHS restrictions and prohibits use of the following substances in concentrations exceeding 0.1% by weight (1000 ppm) except for cadmium, limited to 0.01% by weight (100 ppm).

- Lead (Pb)
- Mercury (Hg)
- Cadmium (Cd)
- Hexavalent chromium (Cr6+)
- Polybrominated biphenyls (PBB)
- Polybrominated diphenyl ether (PBDE)

## Important Safety Information

Carefully read the precautions before using the board.

### Environmental conditions:

- Use this product in environments with ambient temperatures between 0°C and 60°C.
- Do not leave this product in an environment where the storage temperature may be below -20° C or above 80° C. The product must be used in a controlled environment.

### Care for your iBASE products:

- Before cleaning the PCB, unplug all cables and remove the battery.
- Clean the PCB with a circuit board cleaner or degreaser, or use cotton swabs and alcohol.
- Vacuum the dust with a computer vacuum cleaner to prevent the fan from being clogged.



### WARNING

### Attention during use:

- Do not use this product near water or a heat source.
- Do not spill water or any other liquids on this product.
- Do not place heavy objects on the top of this product.

### Anti-static precautions

- Wear an anti-static wrist strap to avoid electrostatic discharge.
- Place the PCB on an anti-static kit or mat.
- Hold the edges of PCB when handling.
- Touch the edges of non-metallic components of the product instead of the surface of the PCB.
- Ground yourself by touching a grounded conductor or a grounded bit of metal frequently to discharge any static.



### CAUTION

There is a danger of explosion if the internal lithium-ion battery is replaced by an incorrect battery. Replace only with the same or equivalent type recommended by the manufacturer. Dispose of used batteries by observing local regulations.

## Warranty Policy

- **IBASE standard products:**

24-month (2-year) warranty from the date of shipment. If the date of shipment cannot be ascertained, the product serial numbers can be used to determine the approximate shipping date.

- **3<sup>rd</sup>-party parts:**

12-month (1-year) warranty from delivery for the 3<sup>rd</sup>-party parts that are not manufactured by IBASE, such as CPU, CPU cooler, memory, storage devices, power adapter, panel and touchscreen.

- \* PRODUCTS, HOWEVER, THAT FAIL DUE TO MISUSE, ACCIDENT, IMPROPER INSTALLATION OR UNAUTHORIZED REPAIR SHALL BE TREATED AS OUT OF WARRANTY AND CUSTOMERS SHALL BE BILLED FOR REPAIR AND SHIPPING CHARGES.

## Technical Support & Services

1. Visit the IBASE website at [www.ibase.com.tw](http://www.ibase.com.tw) to find the latest information about the product.
2. If you encounter any technical problems and require assistance from your distributor or sales representative, please prepare and send the following information:
  - Product model name
  - Product serial number
  - Detailed description of the problem
  - The error messages in text or in screenshots if there is any
  - The arrangement of the peripherals
  - Software in use (such as OS and application software, including the version numbers)
3. If repair service is required, please log in to the RMA system of the website or and contact your distributor or sales representative for assistance.

# Table of Contents

---

<b>Compliance</b> .....	<b>iii</b>
<b>Important Safety Information</b> .....	<b>iv</b>
<b>Warranty Policy</b> .....	<b>v</b>
<b>Technical Support &amp; Services</b> .....	<b>v</b>
<b>Chapter 1      General Information</b> .....	<b>1</b>
1.1    Introduction .....	2
1.2    Features .....	2
1.3    Packing List .....	3
1.4    Optional Accessories .....	3
1.5    Specifications .....	4
1.6    Block Diagram .....	6
1.7    Overview .....	7
1.8    Dimensions .....	9
<b>Chapter 2      Hardware Configuration</b> .....	<b>11</b>
2.1    Essential Installations .....	12
2.1.1    Installing the Memory .....	12
2.1.2    Installing the Mini-PCIe / M.2 Card .....	13
2.2    Setting the Jumpers .....	14
2.2.1    How to Set Jumpers .....	14
2.3    Jumper & Connector Locations .....	15
2.4    Jumpers Quick Reference .....	16
2.4.1    Clearing CMOS Data (JP1) .....	16
2.4.2    eDP / LVDS Selection (JP2) .....	17
2.4.3    PWM Backlight Control Selection (JP3) .....	18
2.4.4    Backlight Power Control Selection (JP4) .....	18
2.4.5    eDP Power Selection (JP5) .....	19
2.4.6    LCD Panel Power Selection (JP6) .....	20
2.5    Connectors Quick Reference .....	21
2.5.1    eDP Connector (CN1) .....	22
2.5.2    ATX Power Connector (J13) .....	23
2.5.3    DC Power Input Connector (J14) .....	24
2.5.4    Digital I/O Connector (J12) .....	24
2.5.5    COM1 RS-232/422/485 Port & COM2 RS-232 Port (CN2) .....	25
2.5.6    COM3 & COM4 RS-232 Port (CN3) .....	26
2.5.7    COM5 & COM6 RS-232 Port (J16, J17) .....	27
2.5.8    Fan Power Connector (CPU_FAN1, SYS_FAN1, SYS_FAN2) .....	28
2.5.9    Front Panel Setting Connector (J3) .....	29

2.5.10	SATA Power Connector (J9, J11)	30
2.5.11	USB 2.0 Connector (J10)	30
2.5.12	LCD Backlight Connector (J18)	31
2.5.13	Speaker Connector (J19)	32
2.5.14	LVDS Connector (J20, J21)	33
2.5.15	Audio Connector (J22)	34
<b>Chapter 3</b>	<b>Drivers Installation</b>	<b>35</b>
3.1	Introduction	36
3.2	Graphics Drivers Installation	36
3.3	HD Audio Driver Installation	38
3.4	LAN Drivers Installation	40
<b>Chapter 4</b>	<b>BIOS Setup</b>	<b>42</b>
4.1	Introduction	43
4.2	BIOS Setup	43
4.3	Main Settings	44
4.4	Advanced Settings	45
4.4.1	ACPI Computing	46
4.4.2	IDE Configuration	46
4.4.3	LVDS Configuration	47
4.4.4	iSmart Controller	48
4.4.5	NCT6116D Super IO Configuration	49
4.4.6	Hardware Monitor	56
4.4.7	CPU Configuration	57
4.4.8	CSM Configuration	58
4.4.9	USB Configuration	60
4.5	Chipset Settings	61
4.5.1	South Bridge	61
4.5.2	GFX Configuration	63
4.5.3	North Bridge Configuration	63
4.6	Security Settings	64
4.7	Boot Settings	65
4.8	Save & Exit Settings	66
<b>Appendix</b>		<b>67</b>
A.	I/O Port Address Map	68
B.	Interrupt Request Lines (IRQ)	71
C.	Watchdog Timer Configuration	72
D.	On-Board Connector Types	77

This page is intentionally left blank.

# Chapter 1

## General Information

The information provided in this chapter includes:

- Features
- Packing List
- Optional Accessories
- Specifications
- Block Diagram
- Board Overview
- Board Dimensions

## 1.1 Introduction

MI979 is a Mini-ITX motherboard based on the AMD R-Series / G-series SoC. This board features HDMI and DisplayPort at the I/O coastline and onboard headers for eDP and 24-bit dual channel LVDS interfaces. The board's operating temperature ranges from 0°C to 60 °C.



**Photo of MI979**

## 1.2 Features

- Mini-ITX with AMD R-series / G-Series SoC, up to 3.4GHz
- DDR4 SO-DIMM socket, expandable up to 32 GB with ECC support
- 1 x HDMI, 1 x DisplayPort
- 1 x 24-bit dual channel LVDS or eDP (for MI979MF series only)
- 2 x GbE LAN, 2 x USB 3.0, 4 x USB 2.0, 6 x COM, 2 x SATA III, 1 x mSATA
- 1 x PCIe (x8), 1 x Mini-PCIe slot, 1 x M.2 B2242 slot
- 1 x SIM Card Slot
- Support of iSmart, configurable watchdog timer and digital I/O

## 1.3 Packing List

Your MI979 package should include the items listed below. If any of the items below is missing, contact the distributor or dealer from whom you purchased the product.

- MI979 x 1
- IO Shield x 1
- SATA Cable x 1  
(SATA-3F for ATX power connector;  
SATA-53A for DC-In power connector)
- COM Cable (PK1H) x 1
- USB 2.0 Cable (USB-29) x 1

## 1.4 Optional Accessories

IBASE provides the following optional accessories:

- Audio cable (Audio-34)
- Mini-PCIe Bracket (MPCIE-EXT)

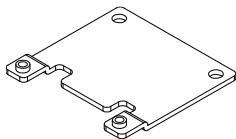

## 1.5 Specifications

Product Name	MI979MF-421 / MI979MF-421D	MI979MF-216 / MI979MF-216D	MI979BF-217
Form Factor	Mini-ITX Motherboard		
<b>System</b>			
Operating System	<ul style="list-style-type: none"> <li>Windows 10 (64-bit)</li> <li>Windows 7 (64-bit)</li> <li>Linux Ubuntu</li> </ul>		
CPU (SoC)	AMD RX-421BD QC	AMD RX-216GD DC	AMD GX-217GI DC
CPU Speed	2.1 ~ 3.4 GHz	1.6 ~ 3.0 GHz	1.7 ~ 2.0 GHz
Cache	2 MB L2	1 MB L2	1 MB L2
TDP	12 ~ 35W	12 ~ 15W	12 ~ 15W
Chipset	Integrated		
Memory	2 x DDR4-2400 SO-DIMM, expandable up to 32 GB with ECC	2 x DDR4-1600 SO-DIMM, expandable up to 32 GB with ECC	1 x DDR4-1600 SO-DIMM, expandable up to 16 GB, non-ECC
Storage	mSATA SSD		
Graphics	Integrated with AMD Radeon HD9000 series graphics core		
Network	2 x Intel® I211AT PCIe Gigabit Ethernet		
Super I/O	Nuvoton NCT6116D		
Audio Codec & Controller	Built-in HD audio controller Realtek ALC662 codec with 5.1 channel		
Power Requirement	<b>MI979MF-421:</b> ATX Power  <b>MI979MF-421D:</b> DC-In 12 ~ 24V	<b>MI979MF-216:</b> ATX Power  <b>MI979MF-216D:</b> DC-In 12 ~ 24V	ATX Power
Digital I/O	4-In / 4-Out		
Watchdog Timer	Yes (256 segments, 0 = disable, 1, 2...255 sec / min)		
BIOS	AMI BIOS		
iSmart	Yes		
H/W Monitor	Yes		
Dimensions	170 x 170 mm (6.7" x 6.7")		
RoHS	Yes		
Certification	CE, FCC Class B, LVD		

Product Name	MI979MF-421 / MI979MF-421D	MI979MF-216 / MI979MF-216D	MI979BF-217
<b>I/O Ports</b>			
<b>Display</b>	<ul style="list-style-type: none"> <li>• <b>1 x HDMI (1.4b)</b>, 3840 x 2160 at 30 Hz</li> <li>• <b>1 x DisplayPort</b>, 3840 x 2160 at 60 Hz</li> <li>• <b>1 x eDP / 24-bit dual channel LVDS</b>  <b>eDP:</b> 1920 x 1080 at 60 Hz  <b>LVDS:</b> 1920 x 1200 at 60 Hz</li> </ul> <p>* eDP and LVDS do not work at the same time.</p>		<ul style="list-style-type: none"> <li>• <b>1 x HDMI (1.4b)</b>, 3840 x 2160 at 30 Hz</li> <li>• <b>1 x Display Port</b>, 3840 x 2160 at 60 Hz</li> </ul>
<b>LAN</b>	2 x RJ45 GbE LAN		
<b>USB</b>	<ul style="list-style-type: none"> <li>• <b>2 x USB 3.0:</b> 2 ports are the edge I/O connectors</li> <li>• <b>4 x USB 2.0:</b> 2 ports are the edge I/O connectors 2 ports via an onboard header</li> </ul>		
<b>Serial</b>	<p><b>6 x COM ports:</b></p> <ul style="list-style-type: none"> <li>• <b>COM1:</b> RS-232/422/485 (edge I/O connector, jumper-less selection and configurable in BIOS)</li> <li>• <b>COM2 ~ 4:</b> RS-232 only (edge I/O connectors)</li> <li>• <b>COM5 ~ 6:</b> RS-232 only (via onboard box-headers)</li> </ul>		
<b>SATA</b>	2 x SATA III (one is shared with the mini-PCIe slot for mSATA)		
<b>Audio</b>	<ul style="list-style-type: none"> <li>• Line-In</li> <li>• Line-Out</li> <li>• Microphone-Input</li> </ul>		
<b>Expansion Slots</b>	<ul style="list-style-type: none"> <li>• 1 x PCIe (x8) slot</li> <li>• 1 x Mini PCIe slot (full-size) with PCIe, mSATA and USB 2.0</li> <li>• 1 x M.2 B2242 slot with USB 3.0</li> </ul>		
<b>Environment</b>			
<b>Temperature</b>	<ul style="list-style-type: none"> <li>• Operating: 0 ~ 60 °C (32 ~ 140 °F)</li> <li>• Storage: -20 ~ 80 °C (-4 ~ 176 °F)</li> </ul>		
<b>Relative Humidity</b>	0 ~ 90 %, non-condensing at 60 °C		

All specifications are subject to change without prior notice.

## 1.6 Block Diagram

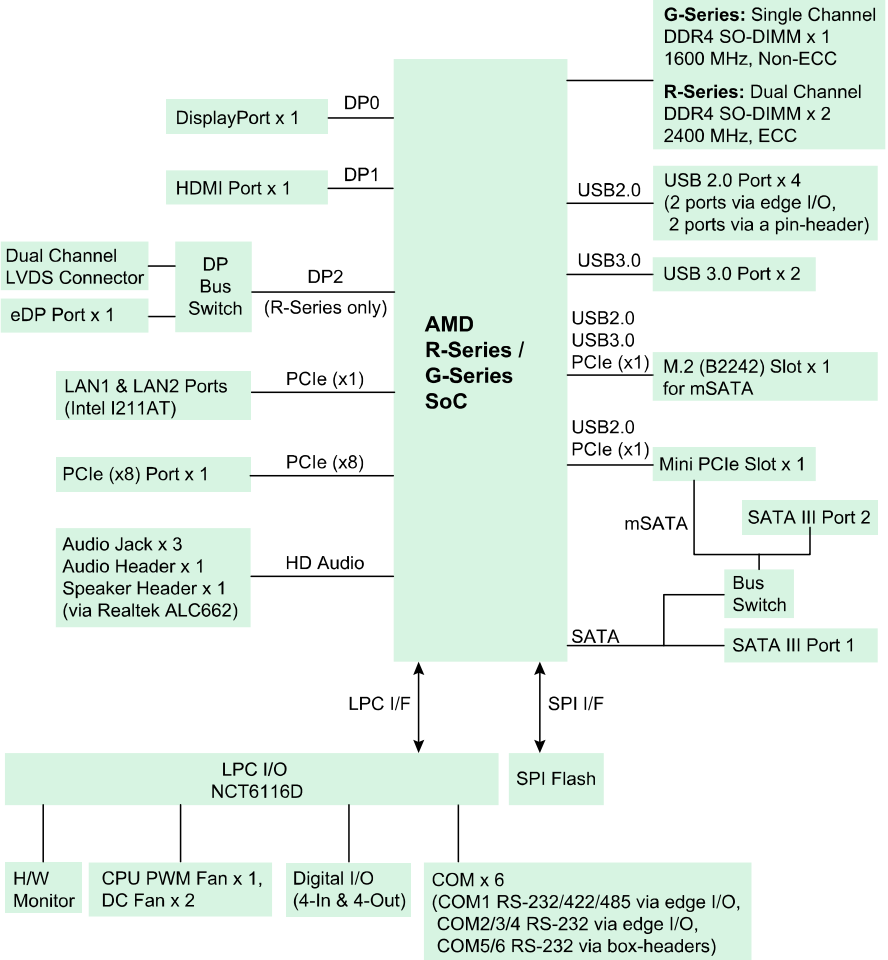

## 1.7 Overview

### Top View



Photo of MI979 (ATX power)

\* The photos above are for reference only. Some minor components may differ.

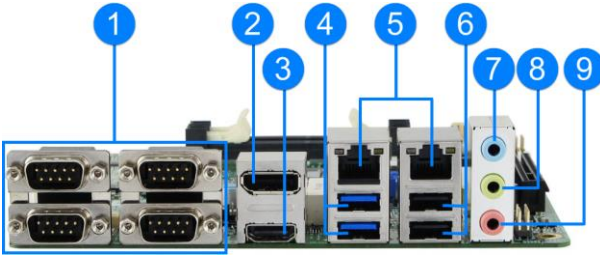
**I/O View**

No.	Name	No.	Name
1	COM Ports	6	USB 2.0 Port
2	DisplayPort	7	Line-In
3	HDMI Port	8	Line-Out
4	USB 3.0 Port	9	Microphone-Input
5	GbE LAN Port		

## 1.8 Dimensions

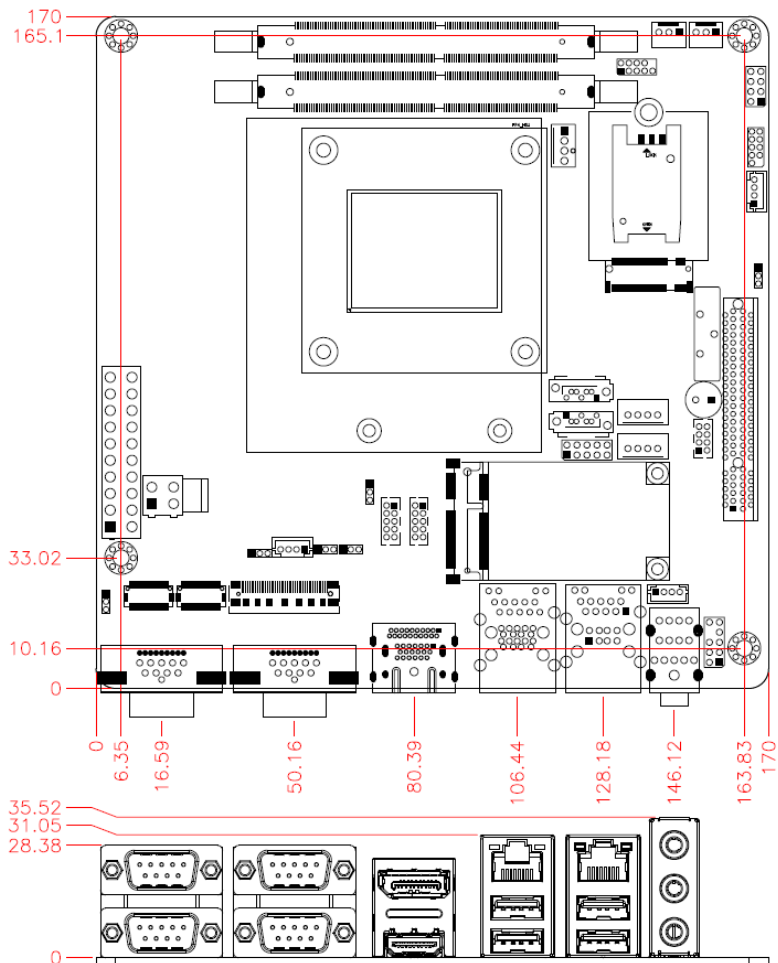

This page is intentionally left blank.

# Chapter 2

## Hardware Configuration

This section provides information on jumper settings and connectors on the MI979 to set up a workable system. The topics covered are:

- Essential installations
- Jumper and connector locations
- Jumper settings and information of connectors

## 2.1 Essential Installations

### 2.1.1 Installing the Memory

To install the modules, locate the memory slot on the board and perform the following steps:

1. Press the ejector tab of the memory slot outwards with your fingertips.



2. Hold the memory module and align the key of the module with that on the memory slot.
3. Gently push the module straight down until the ejector tabs of the memory slot close to hold the module in place when the module touches the bottom of the slot.

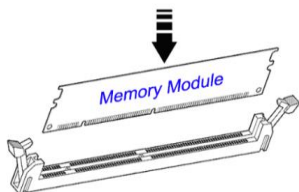

To eject the module, press the ejector tabs outwards with your fingertips.

## 2.1.2 Installing the Mini-PCle / M.2 Card

1. Locate the mini-PCle slot, align the key of the mini-PCle card to the interface, and insert the card slantwise.

(Insert the M.2 card in the same way.)

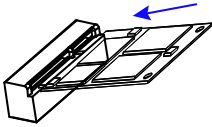

2. Push the mini-PCle card down, fix it with 2 flat head screws for a full-sized card. For a half-sized card use our optional mini-PCle bracket.

(Fix the M.2 card with a screw.)

### Mini-PCle:

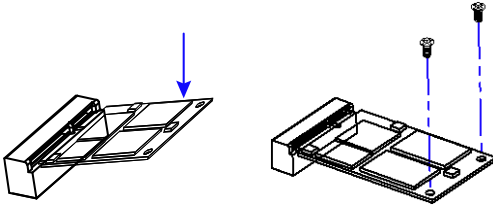

### M.2:

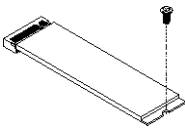

## 2.2 Setting the Jumpers

Configure your MI979 by using jumpers to enable the features that you need based on your applications. Contact your supplier if you have doubts about the best configuration for your use.

### 2.2.1 How to Set Jumpers

Jumpers are short-length conductors consisting of several metal pins with a base mounted on the circuit board. Jumper caps are used to have the functions and features enabled or disabled. If a jumper has 3 pins, you can connect either PIN1 to PIN2 or PIN2 to PIN3 by shorting.

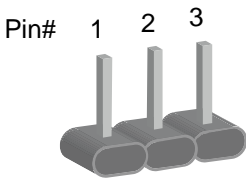

A 3-pin jumper

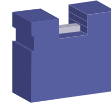

A jumper cap

Refer to the illustration below to set jumpers.

Pin closed	Oblique view	Illustration
Open		
1-2		
2-3		

When two pins of a jumper are encased in a jumper cap, this jumper is **closed**, i.e. turned **On**.

When a jumper cap is removed from two jumper pins, this jumper is **open**, i.e. turned **Off**.

## 2.3 Jumper & Connector Locations

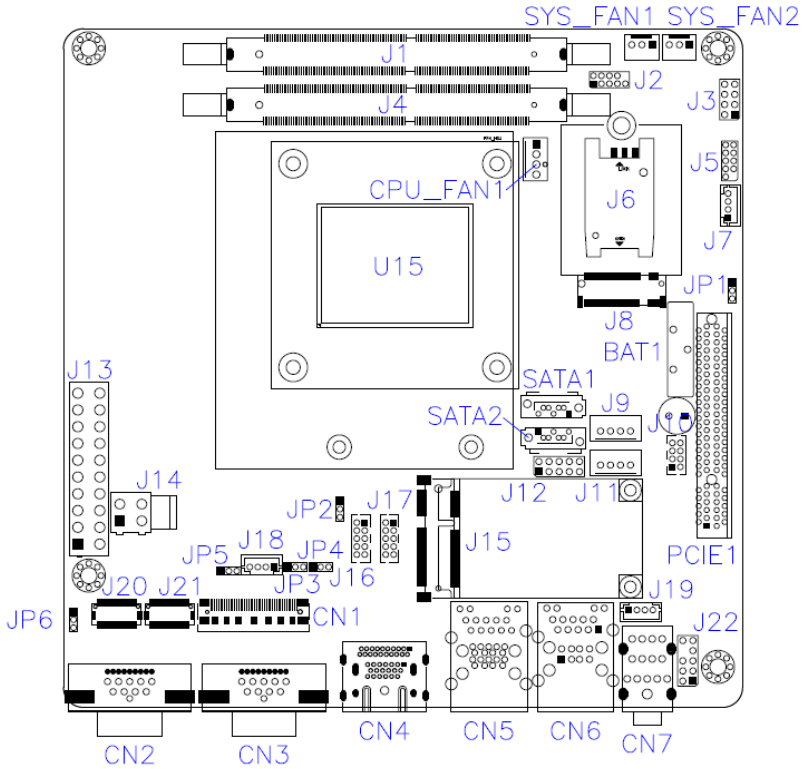

Board diagram of MI979

---

**Note:**

1. **J13** is only available for MI979MF-421, MI979MF-216, and MI979BF-217 using ATX power.
  2. **J14** is only available for MI979MF-216D using DC-In power.
-

## 2.4 Jumpers Quick Reference

Function	Jumper Name	Page
Clearing CMOS Data	JP1	16
eDP / LVDS Selection	JP2	17
PWM Backlight Control Selection	JP3	18
Backlight Power Control Selection	JP4	18
eDP Power Selection	JP5	19
LCD Panel Power Selection	JP6	20

### 2.4.1 Clearing CMOS Data (JP1)

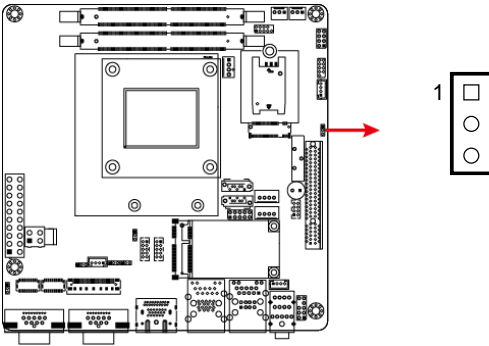

Function	Pin closed	Illustration
Normal (default)	1-2	1
Clear CMOS	2-3	1

### 2.4.2 eDP / LVDS Selection (JP2)

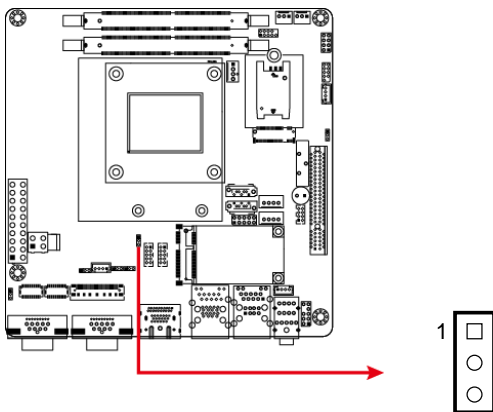

Function	Pin closed	Illustration
Auto: eDP 1 <sup>st</sup> priority & LVDS 2 <sup>nd</sup> priority (default)	1-2	1
LVDS	2-3	1

### 2.4.3 PWM Backlight Control Selection (JP3)

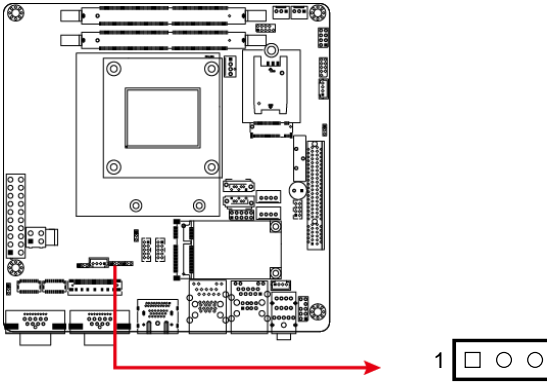

Function	Pin closed	Illustration
3.3V (default)	1-2	1
5V	2-3	1

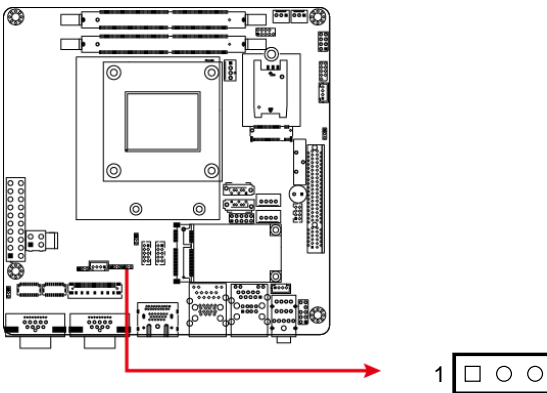

### 2.4.4 Backlight Power Control Selection (JP4)

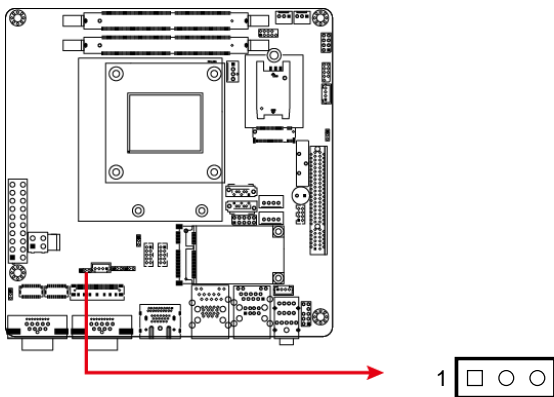

Function	Pin closed	Illustration
3.3V (default)	1-2	1
5V	2-3	1

### 2.4.5 eDP Power Selection (JP5)



Function	Pin closed	Illustration
3.3V (default)	1-2	1 
5V	2-3	1 

## 2.4.6 LCD Panel Power Selection (JP6)

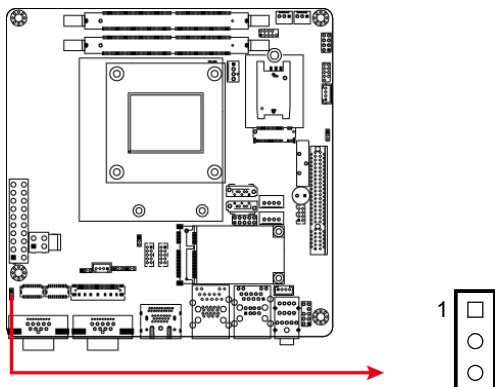

Function	Pin closed	Illustration
3.3V (default)	1-2	1
5V	2-3	1

## 2.5 Connectors Quick Reference

Function	Connector Name	Page
eDP Connector	CN1	22
ATX Power Supply Connector	J13	23
DC Power Input Connector	J14	24
Digital I/O Connector	J12	24
COM1 RS-232/422/485 & COM2 RS-232 Ports	CN2	25
COM3 & COM4 RS-232 Ports	CN3	26
COM5 & COM6 RS-232 Port	J16 (COM5), J17 (COM6)	27
Fan Power Connector	CPU_FAN1, SYS_FAN1, SYS_FAN2	28
Front Panel Setting Connector	J3	29
HDD Power Connector	J9, J11	30
USB 2.0 Connector	J10	30
LCD Backlight Connector	J18	31
Speaker Connector	J19	32
LVDS Connector	J20 (2 <sup>nd</sup> Ch.), J21 (1 <sup>st</sup> Ch.)	33
Audio Connector	J22	34
DisplayPort & HDMI Port	CN4	--
GbE LAN & USB 3.0 Ports	CN5	--
GbE LAN & USB 2.0 Ports	CN6	--
Audio Jacks (Line-In/Out, Mic-In)	CN7	--
DDR4 SO-DIMM Slot	J1, J4	--
SIM Card Socket	J6	--
NGFF M.2 B2242 Slot	J8	--
Mini-PCIe Slot	J15 (shared with SATA1)	--
SATA Port	SATA1 (shared with J15), SATA2	--
PCIe (x8) Slot	PCIE1	--
Factory Use Only	J2, J5, J7	--

## 2.5.1 eDP Connector (CN1)

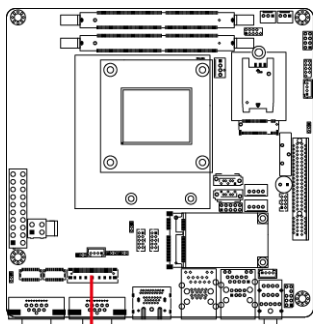

VDD voltage (pins 1 ~ 5) is selectable via the jumper JP5, and it is +3.3V by default.

Pin	Assignment	Pin	Assignment
1	+3.3V (default) / +5V	23	TXN0
2	+3.3V (default) / +5V	24	TXP0
3	+3.3V (default) / +5V	25	GND
4	+3.3V (default) / +5V	26	AUXP
5	+3.3V (default) / +5V	27	AUXN
6	Ground	28	NC
7	Ground	29	VCC3
8	Ground	30	NC
9	Ground	31	VCC12
10	HOT PLUG	32	NC
11	NC	33	Ground
12	NC	34	VCC5
13	Ground	35	NC
14	NC	36	Brightness
15	NC	37	BKLT_EN
16	Ground	38	VCC12
17	NC	39	VCC3
18	NC	40	Ground
19	Ground	41	SMB_CLK
20	TXN1	42	SMB_DATA
21	TXP1	43	NC
22	Ground	44	NC

## 2.5.2 ATX Power Connector (J13)

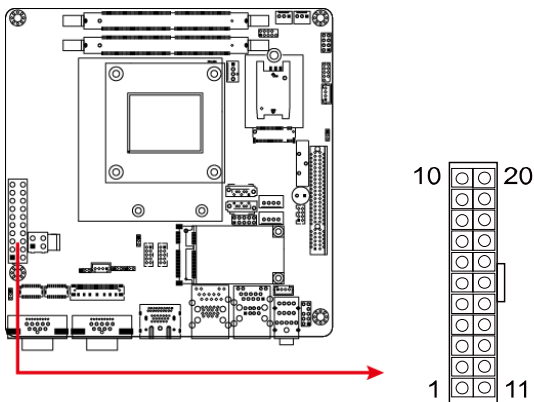

**J13** is only available for MI979MF-421, MI979MF-216, and MI979BF-217.

Pin	Assignment	Pin	Assignment
1	3.3V	11	3.3V
2	3.3V	12	-12V
3	Ground	13	Ground
4	+5V	14	PS-ON
5	Ground	15	Ground
6	+5V	16	Ground
7	Ground	17	Ground
8	Power good	18	-5V
9	5VSB	19	+5V
10	+12V	20	+5V

### 2.5.3 DC Power Input Connector (J14)

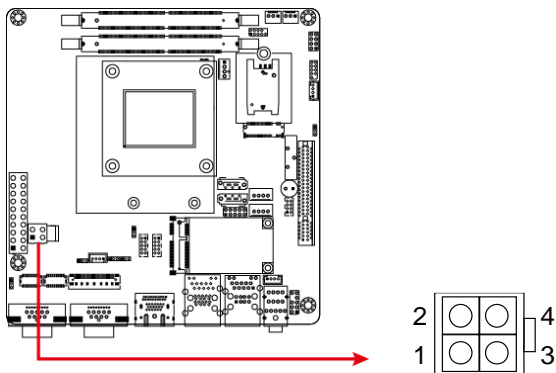

J14 is only available for MI979MF-216D.

Pin	Assignment	Pin	Assignment
1	Ground	2	Ground
3	+12 ~ +19V	4	+12 ~ +19V

### 2.5.4 Digital I/O Connector (J12)

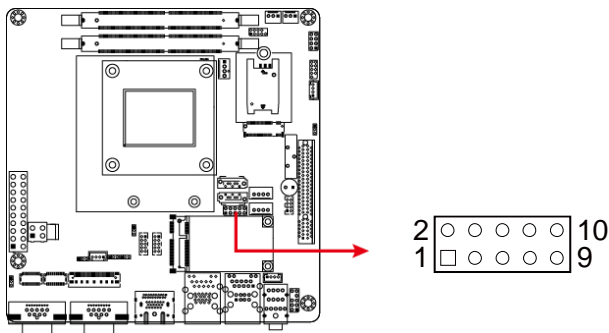

Pin	Assignment	Pin	Assignment
1	Ground	2	+5V
3	OUT3	4	Out1
5	OUT2	6	Out0
7	IN3	8	IN1
9	IN2	10	IN0

### 2.5.5 COM1 RS-232/422/485 Port & COM2 RS-232 Port (CN2)

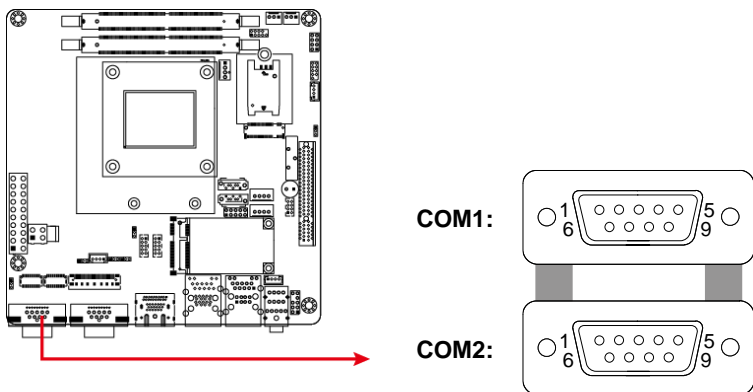

COM1 RS-232/422/485 port is jumper-less and configurable in BIOS.

Pin	Assignment	Pin	Assignment
1	DCD, Data carrier detect	6	DSR, Data set ready
2	RXD, Receive data	7	RTS, Request to send
3	TXD, Transmit data	8	CTS, Clear to send
4	DTR, Data terminal ready	9	RI, Ring indicator
5	Ground		

Pin	Assignment		
	RS-232	RS-422	RS-485
1	DCD	TX-	Data-
2	RXD	TX+	Data+
3	TXD	RX+	NC
4	DTR	RX-	NC
5	Ground	Ground	Ground
6	DSR	NC	NC
7	RTS	NC	NC
8	CTS	NC	NC
9	RI	NC	NC

## COM2 RS-232 port:

Pin	Assignment	Pin	Assignment
1	DCD, Data carrier detect	6	DSR, Data set ready
2	RXD, Receive data	7	RTS, Request to send
3	TXD, Transmit data	8	CTS, Clear to send
4	DTR, Data terminal ready	9	RI, Ring indicator
5	Ground		

## 2.5.6 COM3 & COM4 RS-232 Port (CN3)

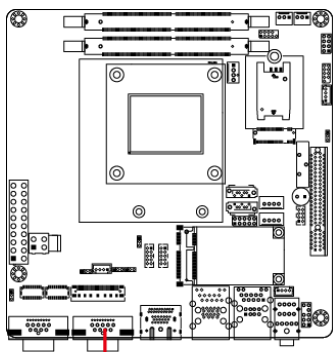

COM3:

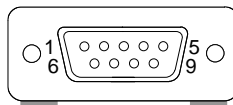

COM4:

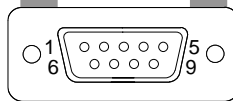

Pin	Assignment	Pin	Assignment
1	DCD, Data carrier detect	6	DSR, Data set ready
2	RXD, Receive data	7	RTS, Request to send
3	TXD, Transmit data	8	CTS, Clear to send
4	DTR, Data terminal ready	9	RI, Ring indicator
5	Ground		

### 2.5.7 COM5 & COM6 RS-232 Port (J16, J17)

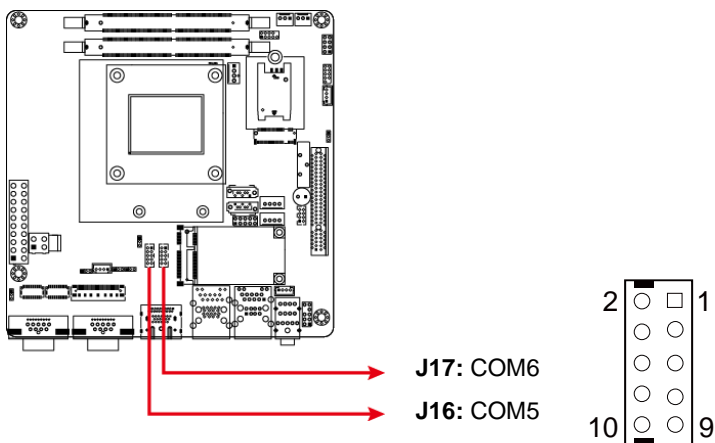

Pin	Assignment	Pin	Assignment
1	DCD, Data carrier detect	2	RXD, Receive data
3	TXD, Transmit data	4	DTR, Data terminal ready
5	Ground	6	DSR, Data set ready
7	RTS, Request to send	8	CTS, Clear to send
9	RI, Ring indicator	10	NC

## 2.5.8 Fan Power Connector (CPU\_FAN1, SYS\_FAN1, SYS\_FAN2)

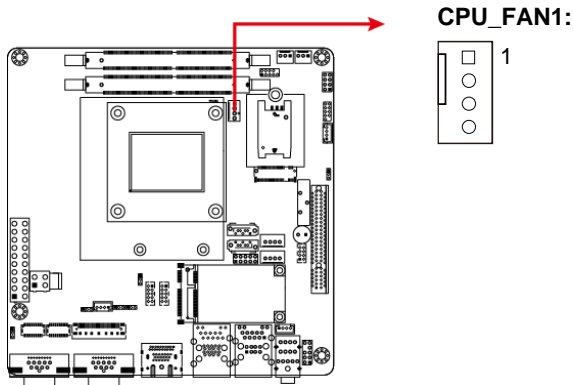

Pin	Assignment	Pin	Assignment
1	Ground	3	Rotation detection
2	+12V	4	Control

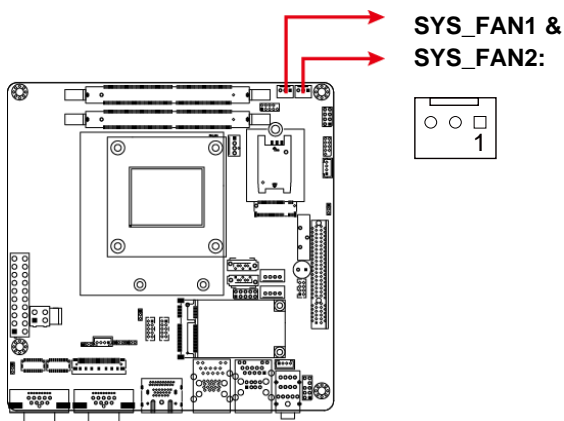

Pin	Assignment	Pin	Assignment
1	Ground	3	Rotation detection
2	+12V		

### 2.5.9 Front Panel Setting Connector ( J3)

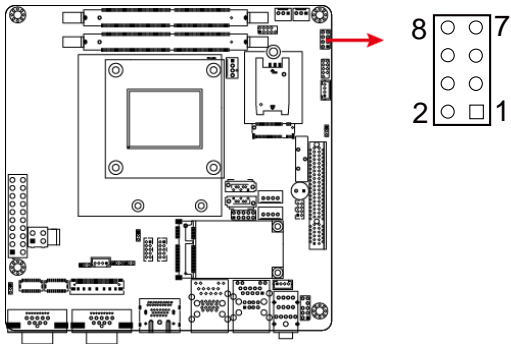

Pin	Assignment	Pin	Assignment
1	Power BTN-	2	Power BTN+
3	HDD LED+	4	HDD LED-
5	Reset BTN-	6	Reset BTN+
7	Power LED+	8	Power LED-

**J3** is utilized for system indicators to provide light indication of the computer activities and switches to change the computer status. It provides interfaces for the following functions.

- ATX Power ON Switch (Pins 1 and 2)**

The 2 pins make an “ATX Power Supply On/Off Switch” for the system that connects to the power switch on the case. When pressed, the power switch will force the system to power on. When pressed again, it will power off the system.
- Hard Disk Drive LED Connector (Pins 3 and 4)**

This connector connects to the hard drive activity LED on control panel. This LED will flash when the HDD is being accessed.
- Reset Switch (Pins 5 and 6)**

The reset switch allows you to reset the system without turning the main power switch off and then on again. Orientation is not required when making a connection to this header.
- Power LED: Pins (7 and 8)**

This connector connects to the system power LED on control panel. This LED will light when the system turns on.

### 2.5.10 SATA Power Connector (J9, J11)

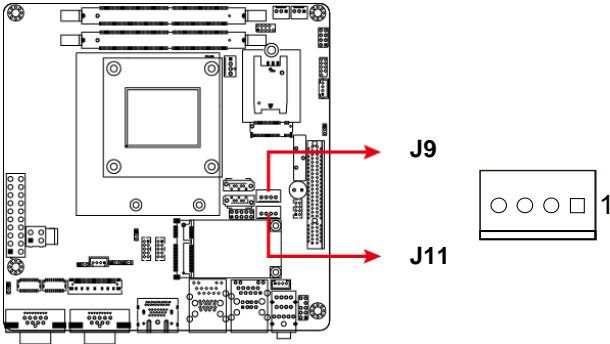

Pin	Assignment	Pin	Assignment
1	+5V	3	Ground
2	Ground	4	+12V

### 2.5.11 USB 2.0 Connector (J10)

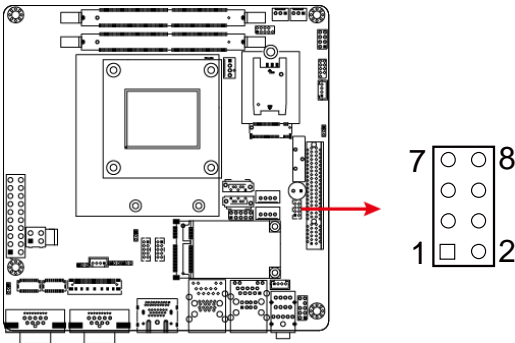

Pin	Assignment	Pin	Assignment
1	+5V	2	Ground
3	Data-	4	Data+
5	Data+	6	Data-
7	Ground	8	+5V

## 2.5.12 LCD Backlight Connector (J18)

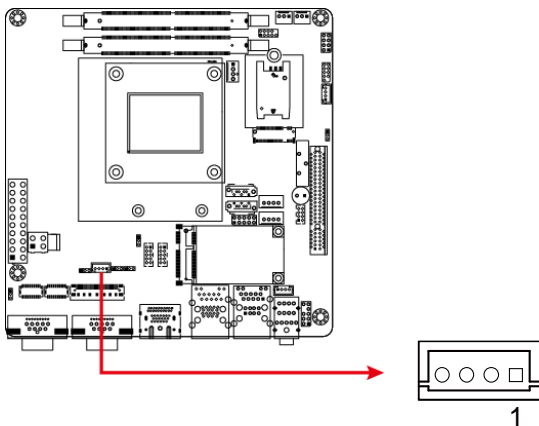

Pin	Assignment	Pin	Assignment
1	+12V	3	Brightness Control
2	Backlight Enable	4	Ground

## 2.5.13 Speaker Connector (J19)

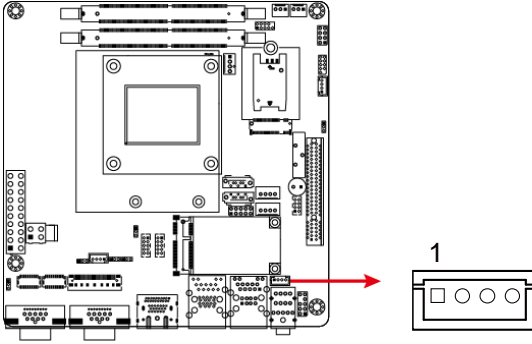

Pin	Assignment	Pin	Assignment
1	Speaker-L+	3	Speaker-R-
2	Speaker-L-	4	Speaker-R+

### 2.5.14 LVDS Connector (J20, J21)

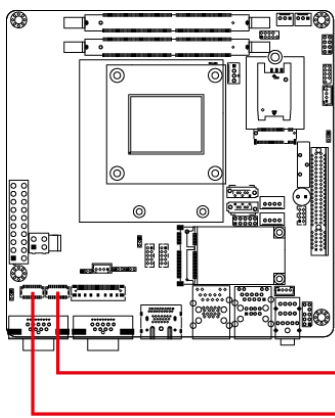

J21: 1<sup>st</sup> channel

J20: 2<sup>nd</sup> channel

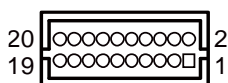

VDD voltage (pins 19 ~ 20) is selectable via the jumper JP6, and it is +3.3V by default.

Pin	Assignment	Pin	Assignment
1	TX0+	2	TX0-
3	Ground	4	Ground
5	TX1+	6	TX1-
7	Ground	8	Ground
9	TX2+	10	TX2-
11	Ground	12	Ground
13	TXC+	14	TXC-
15	Ground	16	Ground
17	TX3+	18	TX3-
19	+3.3 / +5V	20	+3.3 / +5V

### 2.5.15 Audio Connector (J22)

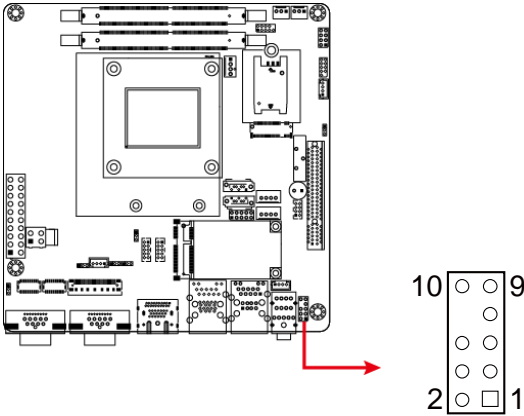

Pin	Assignment	Pin	Assignment
1	MIC IN_L	2	Ground
3	MIC IN_R	4	AUD_DETECT
5	LINE_IN_R	6	JD_MIC_IN
7	Sense	8	KEY
9	LINE_IN_L	10	JD_LINE_IN

# Chapter 3

## Drivers Installation

This chapter introduces installation of the following drivers:

- Graphics Drivers
- HD Audio Drivers
- LAN Drivers

## 3.1 Introduction

This section describes the installation procedures for software and drivers. The contents of this section include the following:

## 3.2 Graphics Drivers Installation

1. Go to the download page of the product. Copy the compressed drivers file to your computer. Double click the file to decompress it. Run “CDGuide” to go to the main drivers page as shown. Click **AMD** and then **AMD Merlin Falcon Drivers**.

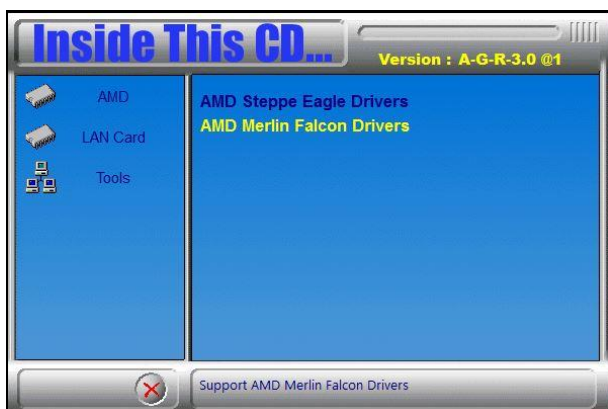

2. Click **AMD Merlin Falcon Graphics Drivers**.

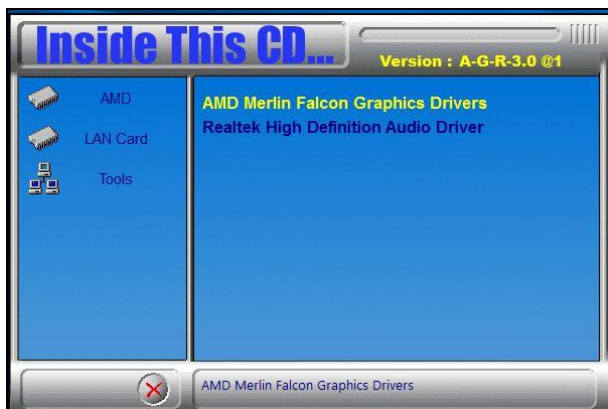

3. When the *AMD Installer* screen appears, click **Install** to continue.

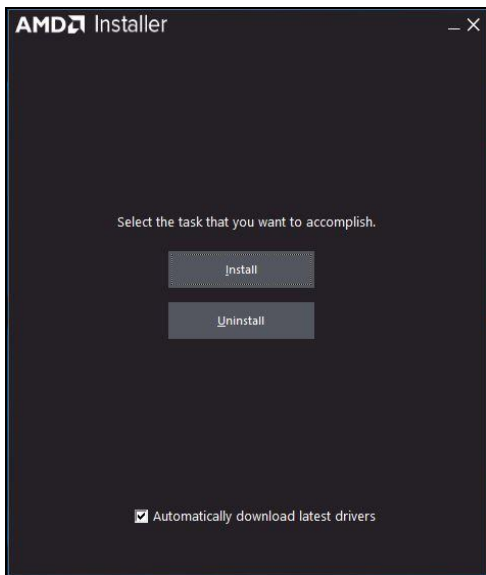

4. Select the desired drivers or the whole package and click **Install**.

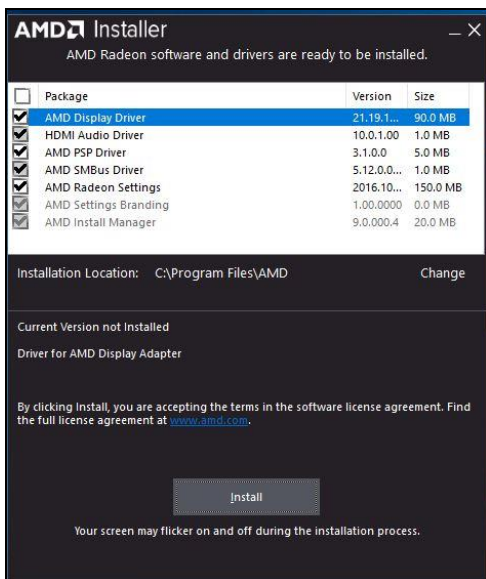

5. The driver has been completely installed. Restart the computer for changes to take effect.

### 3.3 HD Audio Driver Installation

1. Click **AMD** and then **AMD Merlin Falcon Drivers**.

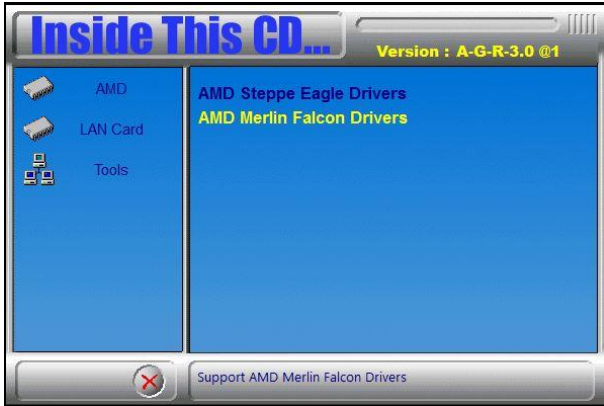

2. Click **Realtek High Definition Audio Driver**.

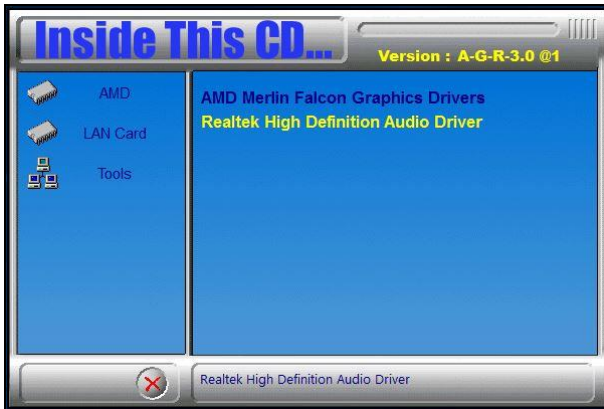

3. On the *Welcome* screen of the InstallShield Wizard, click **Next** for installation.

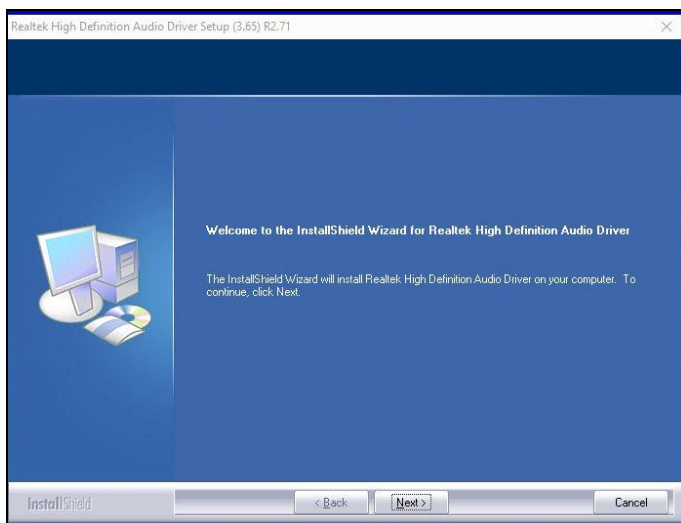

4. Click **Next** until the installation starts.

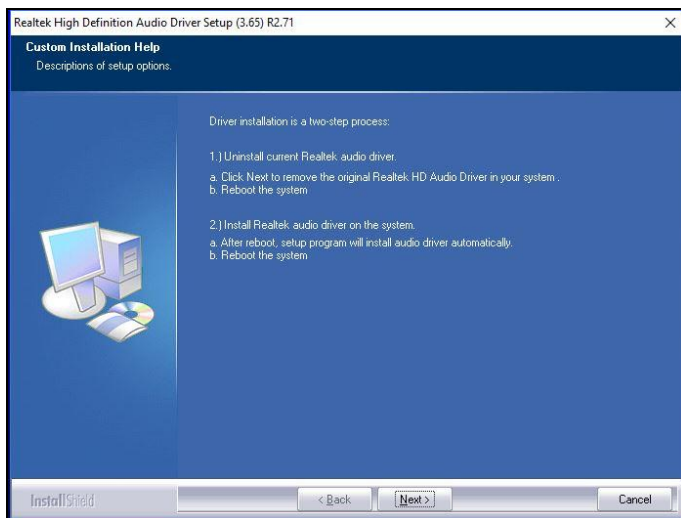

5. The driver has been completely installed. Restart the computer for changes to take effect.

### 3.4 LAN Drivers Installation

1. Click **LAN Card** and then **Intel LAN Controller Drivers**.



2. Click **Intel(R) I21x Gigabit Network Drivers..**

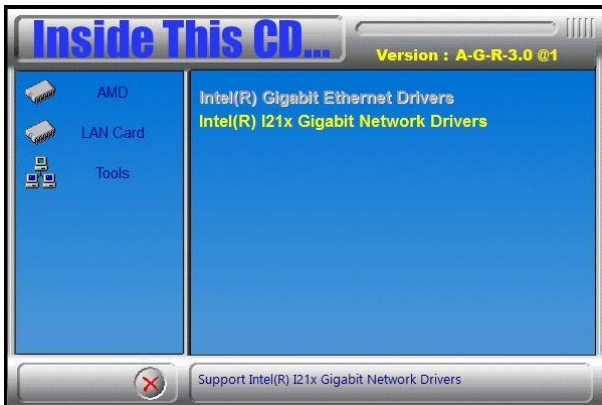

3. When the *Welcome* screen appears, click **Next**.

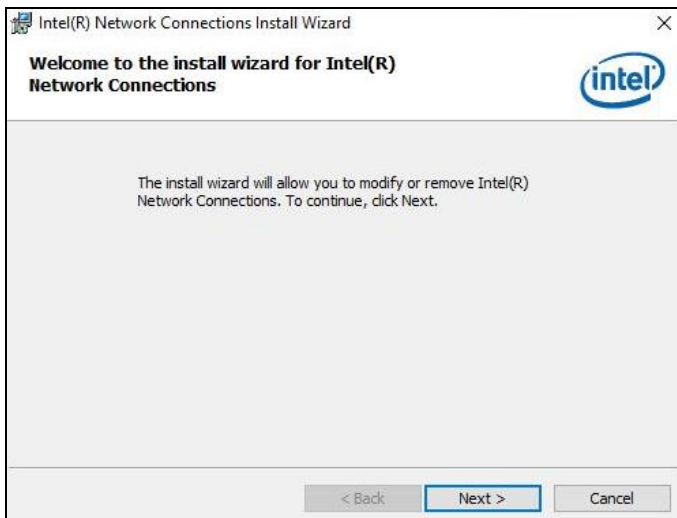

4. As the installation is complete, restart the computer for changes to take effect.

# Chapter 4

## BIOS Setup

This chapter describes the different settings available in the AMI BIOS that comes with the board. The topics covered in this chapter are as follows:

- Main Settings
- Advanced Settings
- Chipset Settings
- Security Settings
- Boot Settings
- Save & Exit

## 4.1 Introduction

The BIOS (Basic Input/Output System) installed in the ROM of your computer system supports AMD processors. The BIOS provides critical low-level support for standard devices such as disk drives, serial ports and parallel ports. It also provides password protection as well as special support for detailed fine-tuning of the chipset controlling the entire system.

## 4.2 BIOS Setup

The BIOS provides a Setup utility program for specifying the system configurations and settings. The BIOS ROM of the system stores the Setup utility. When you turn on the computer, the BIOS is immediately activated. Press the <Del> key immediately allows you to enter the Setup utility. If you are a little bit late pressing the <Del> key, POST (Power On Self Test) will continue with its test routines, thus preventing you from invoking the Setup.

If you still need to enter Setup, restart the system by pressing the "Reset" button or simultaneously pressing the <Ctrl>, <Alt> and <Delete> keys. You can also restart by turning the system Off and back On again.

The following message will appear on the screen:

```
Press <DEL> to Enter Setup
```

In general, press the arrow keys to highlight items, <Enter> to select, the <PgUp> and <PgDn> keys to change entries, <F1> for help, and <Esc> to quit.

When you enter the BIOS Setup utility, the *Main Menu* screen will appear on the screen. The Main Menu allows you to select from various setup functions and exit choices.

---

**Warning:** It is strongly recommended that you avoid making any changes to the chipset defaults.

These defaults have been carefully chosen by both AMI and your system manufacturer to provide the absolute maximum performance and reliability. Changing the defaults could make the system unstable and crash in some cases.

---

### 4.3 Main Settings



BIOS Setting	Description
System Date	Sets the date. Use the <Tab> key to switch between the date elements.
System Time	Set the time. Use the <Tab> key to switch between the time elements.

## 4.4 Advanced Settings

This section allows you to configure, improve your system and allows you to set up some system features according to your preference.



BIOS Setting	Description
ACPI Settings	System ACPI Parameters.
IDE Configuration	Configures IDE devices.
LVDS Configuration	Configures LVDS.
iSmart Controller	Set up the power-on time for the system.
NC6116D Super IO Configuration	System super I/O parameters.
Hardware Monitor	Displays the status of hardware monitoring.
CPU Configuration	CPU configuration para
CSM Configuration	Enables / Disables the Option ROM execution settings, etc.
USB Configuration	USB configuration parameters.

## 4.4.1 ACPI Computing



BIOS Setting	Description
Enable Hibernation	Enables / Disables the system ability to hibernate (OS/S4 Sleep State). This option may be not effective with some OS.
ACPI Sleep State	Selects an ACPI sleep state (Suspend Disabled or S3) where the system will enter when the Suspend button is pressed.

## 4.4.2 IDE Configuration

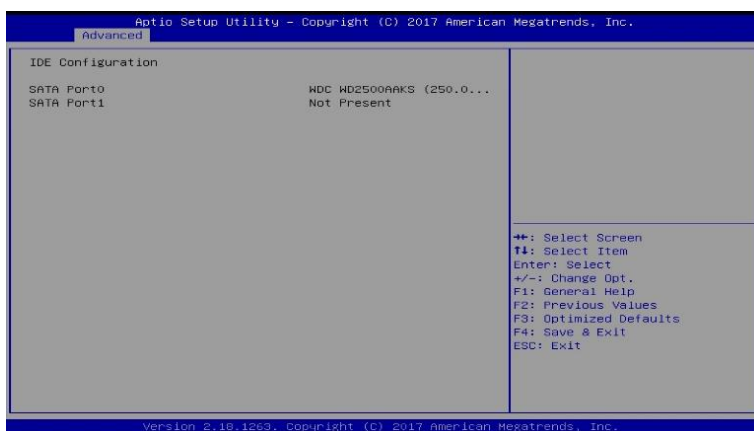

### 4.4.3 LVDS Configuration



BIOS Setting	Description
LVDS Control	Enables / Disables LVDS control.
Panel Color Depth	Selects a panel color depth as 18 or 24 bit.
LVDS Channel Type	Sets the LVDS channel type as single or dual channel.
Panel Type	Selects a resolution that fits your panel.  Options: 800 x 480 / 800 x 600 / 1024 x 768 / 1280 x 768 / 1280 x 800 / 1280 x 960 / 1280 x 1024 / 1366 x 768 / 1440 x 900 / 1600 x 900 / 1600 x 1200 / 1680 x 1200 / 1680 x 1050 / 1920 x 1080 / 1920 x 1200
Backlightness Control	Enables / Disables the brightness.

## 4.4.4 iSmart Controller



BIOS Setting	Description
Power-On after Power failure	Enables / Disables the system to be turned on automatically after a power failure.
Temperature Guardian	Enables / Disables the function of temperature guardian.
Schedule Slot 1 / 2	<p>Sets up the hour / minute for system power-on.</p> <p><b>Important:</b> If you would like to set up a schedule between adjacent days, configure two schedule slots.</p> <p>For example, if setting up a schedule from Wednesday 5 p.m. to Thursday 2 a.m., configure two schedule slots. But if setting up a schedule from 3 p.m to 5 p.m. on Wednesday, configure only a schedule slot.</p>

## 4.4.5 NCT6116D Super IO Configuration

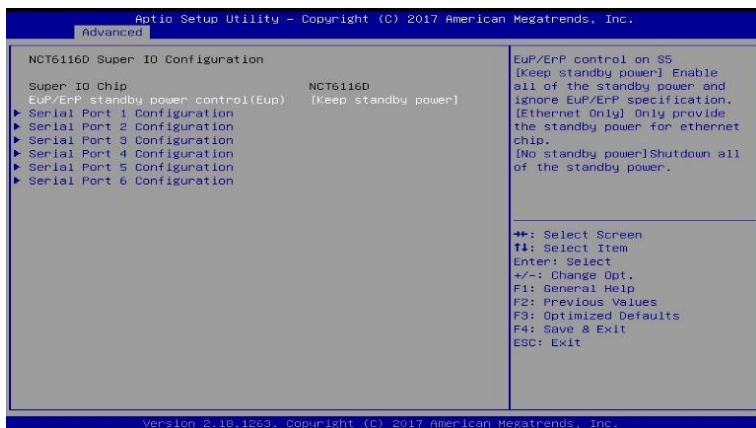

BIOS Setting	Description
EuP/ErP Standby Power on S5 (EuP)	<p>Enables / Disables to provide the standby power for devices.</p> <p><b>Keep standby power</b> enables all of the standby power and ignore EuP/ErP specification.</p> <p><b>Ethernet Only (WOL)</b> only provides the standby power for the Ethernet chip.</p> <p><b>No standby power</b> shuts down all of the standby power.</p>
Serial Ports Configuration	<p>Sets parameters of serial ports.</p> <p>Enables / Disables the serial port and select an optimal setting for the Super IO device.</p>

### 4.4.5.1. Serial Port 1 Configuration



BIOS Setting	Description
Serial Port	Enables / Disables the serial port (COM).
Change Settings	<p>Selects an optimal settings for Super IO device.</p> <p>Options:</p> <ul style="list-style-type: none"> <li>• Auto</li> <li>• IO = 3F8h; IRQ = 4</li> <li>• IO = 3F8h; IRQ = 3, 4, 5, 6, 7, 9, 10, 11, 12</li> <li>• IO = 2F8h; IRQ = 3, 4, 5, 6, 7, 9, 10, 11, 12</li> <li>• IO = 3E8h; IRQ = 3, 4, 5, 6, 7, 9, 10, 11, 12</li> <li>• IO = 2E8h; IRQ = 3, 4, 5, 6, 7, 9, 10, 11, 12</li> </ul>
Serial Port Mode Select	<p>Changes the serial port mode to:</p> <ul style="list-style-type: none"> <li>• RS232</li> <li>• RS485</li> <li>• RS422</li> </ul>

### 4.4.5.2. Serial Port 2 Configuration



BIOS Setting	Description
Serial Port	Enables / Disables the serial port (COM).
Change Settings	<p>Selects an optimal settings for Super IO device.</p> <p>Options:</p> <ul style="list-style-type: none"> <li>• Auto</li> <li>• IO = 2F8h; IRQ = 3</li> <li>• IO = 3F8h; IRQ = 3, 4, 5, 6, 7, 9, 10, 11, 12</li> <li>• IO = 2F8h; IRQ = 3, 4, 5, 6, 7, 9, 10, 11, 12</li> <li>• IO = 3E8h; IRQ = 3, 4, 5, 6, 7, 9, 10, 11, 12</li> <li>• IO = 2E8h; IRQ = 3, 4, 5, 6, 7, 9, 10, 11, 12</li> </ul>

### 4.4.5.3. Serial Port 3 Configuration



BIOS Setting	Description
Serial Port	Enables / Disables the serial port (COM).
Change Settings	<p>Selects an optimal settings for Super IO device.</p> <p>Options:</p> <ul style="list-style-type: none"> <li>• Auto</li> <li>• IO = 3E8h; IRQ = 5</li> <li>• IO = 3E8h; IRQ = 3, 4, 5, 6, 7, 9, 10, 11, 12</li> <li>• IO = 2E8h; IRQ = 3, 4, 5, 6, 7, 9, 10, 11, 12</li> <li>• IO = 338h; IRQ = 3, 4, 5, 6, 7, 9, 10, 11, 12</li> <li>• IO = 238h; IRQ = 3, 4, 5, 6, 7, 9, 10, 11, 12</li> </ul>

### 4.4.5.4. Serial Port 4 Configuration



BIOS Setting	Description
Serial Port	Enables / Disables the serial port (COM).
Change Settings	<p>Selects an optimal settings for Super IO device.</p> <p>Options:</p> <ul style="list-style-type: none"> <li>• Auto</li> <li>• IO = 2E8h; IRQ = 5</li> <li>• IO = 3E8h; IRQ = 3, 4, 5, 6, 7, 9, 10, 11, 12</li> <li>• IO = 2E8h; IRQ = 3, 4, 5, 6, 7, 9, 10, 11, 12</li> <li>• IO = 338h; IRQ = 3, 4, 5, 6, 7, 9, 10, 11, 12</li> <li>• IO = 238h; IRQ = 3, 4, 5, 6, 7, 9, 10, 11, 12</li> </ul>

### 4.4.5.5. Serial Port 5 Configuration



BIOS Setting	Description
Serial Port	Enables / Disables the serial port (COM).
Change Settings	<p>Selects an optimal settings for Super IO device.</p> <p>Options:</p> <ul style="list-style-type: none"> <li>• Auto</li> <li>• IO = 238h; IRQ = 7</li> <li>• IO = 3E8h; IRQ = 3, 4, 5, 6, 7, 9, 10, 11, 12</li> <li>• IO = 2E8h; IRQ = 3, 4, 5, 6, 7, 9, 10, 11, 12</li> <li>• IO = 338h; IRQ = 3, 4, 5, 6, 7, 9, 10, 11, 12</li> <li>• IO = 238h; IRQ = 3, 4, 5, 6, 7, 9, 10, 11, 12</li> </ul>

### 4.4.5.6. Serial Port 6 Configuration



BIOS Setting	Description
Serial Port	Enables / Disables the serial port (COM).
Change Settings	<p>Selects an optimal settings for Super IO device.</p> <p>Options:</p> <ul style="list-style-type: none"> <li>• Auto</li> <li>• IO = 338h; IRQ = 10</li> <li>• IO = 3E8h; IRQ = 3, 4, 5, 6, 7, 9, 10, 11, 12</li> <li>• IO = 2E8h; IRQ = 3, 4, 5, 6, 7, 9, 10, 11, 12</li> <li>• IO = 338h; IRQ = 3, 4, 5, 6, 7, 9, 10, 11, 12</li> <li>• IO = 238h; IRQ = 3, 4, 5, 6, 7, 9, 10, 11, 12</li> </ul>

## 4.4.6 Hardware Monitor



BIOS Setting	Description
CPU / System smart fan control	Enables / Disables the smart fan feature. Options: Disabled / 50 °C / 60 °C / 70 °C / 80 °C / 90 °C
Temperatures / Voltages	These fields are the parameters of the hardware monitoring function feature of the motherboard. The values are read-only values as monitored by the system and show the PC health status.
CPU Shutdown Temperature	Sets a threshold of temperature to shut down if CPU goes overheated. Options: Disabled / 70 °C / 75 °C / 80 °C / 85 °C / 90 °C / 95 °C

## 4.4.7 CPU Configuration



BIOS Setting	Description
Node 0 CPU Information	Displays the memory information related to the Node 0.

## 4.4.8 CSM Configuration



BIOS Setting	Description
CSM Support	Enables / Disables CSM support.
GateA20 Active	<ul style="list-style-type: none"> <li>• <b>Upon Request</b> disables GA20 when using BIOS services.</li> <li>• <b>Always</b> cannot disable GA20, but is useful when any RT code is executed above 1 MB.</li> </ul>
Option ROM Messages	Sets the display mode for the Option ROM. Options: Fore BIOS / Keep Current.
INT19 Trap Response	Sets how BIOS reacts on INT19 trap by Option ROM. <ul style="list-style-type: none"> <li>• <b>Immediate</b> executes the trap right away.</li> <li>• <b>Postponed</b> executes the trap during legacy boot.</li> </ul>
Boot option filter	Controls the priority of Legacy and UEFI ROMs. Options: UEFI and Legacy / Legacy only / UEFI only
Network	Contrlrs the execution of UEFI and Legacy PXE OpROM. Options: Do not launch / Legacy

BIOS Setting	Description
Storage	Controls the execution of UEFI and Legacy Storage OpROM. Options: Do not Launch / UEFI / Legacy
Video	Controls the execution of UEFI and Legacy Video OpROM. Options: Do not Launch / UEFI / Legacy
Other PCI devices	Determines OpROM execution policy for devices other than network, storage or video. Options: Do not Launch / UEFI / Legacy

## 4.4.9 USB Configuration

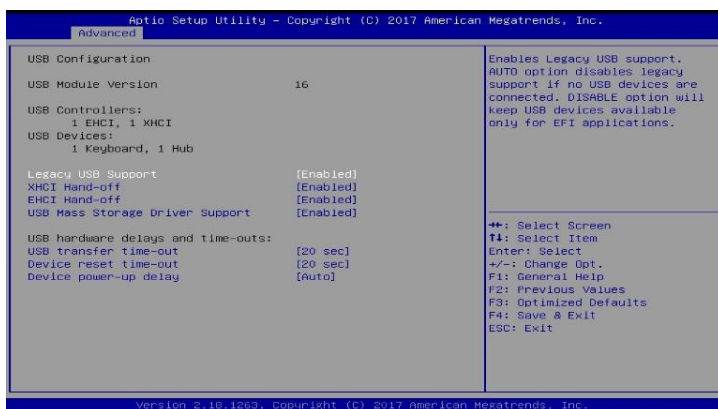

BIOS Setting	Description
Legacy USB Support	<ul style="list-style-type: none"> <li>• <b>Enabled</b> enables Legacy USB support.</li> <li>• <b>Auto</b> disables legacy support if there is no USB device connected.</li> <li>• <b>Disabled</b> keeps USB devices available only for EFI applications.</li> </ul>
XHCI Hand-off	This is a workaround for OSeS without XHCI hand-off support. The XHCI ownership change should be claimed by XHCI driver.
EHCI Hand-off	This is a workaround for OSeS without XHCI hand-off support. The EHCI ownership change should be claimed by EHCI driver.
USB Mass Storage Driver Support	Enables / Disables the support for USB mass storage driver.
USB Transfer time-out	The time-out value (1 / 5 10 / 20 secs) for Control, Bulk, and Interrupt transfers.
Device reset time-out	Gives seconds (10 / 20 / 30 / 40 secs) to delay execution of Start Unit command to USB mass storage device.
Device power-up delay	<p>The maximum time the device will take before it properly reports itself to the Host Controller.</p> <p><b>Auto</b> uses default value for a Root port it is 100ms. But for a Hub port, the delay is taken from Hub descriptor.</p>

## 4.5 Chipset Settings



### 4.5.1 South Bridge



BIOS Setting	Description
SB SATA Configuration	Options for SATA configuration

**4.5.1.1. SB SATA Configuration**

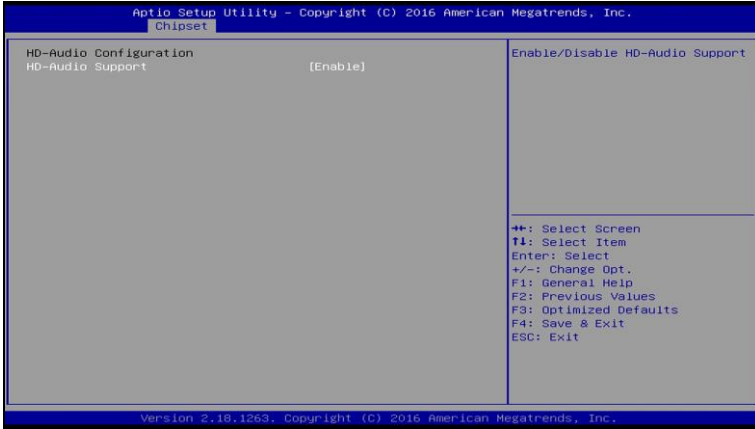

BIOS Setting	Description
OnChip SATA Channel	Enables / Disables the Serial ATA.
OnChip SATA Type	Selects the onchip SATA type as Native IDE or AHCI.

## 4.5.2 GFX Configuration



BIOS Setting	Description
Primary Vdeo Device	Selects the primary vdeo device that BIOS will use for output.  Options: IGD Video, NB PCIe Slot Video
Integrated Graphics	Enables / Disables the integrated graphics controller.  Options: Auto / Disabled / Force
PSPP Policy	PCIe speed power policy  Options: Disabled / Performance / Balanced-High / Balanced-Low / Power Saving

## 4.5.3 North Bridge Configuration



## 4.6 Security Settings

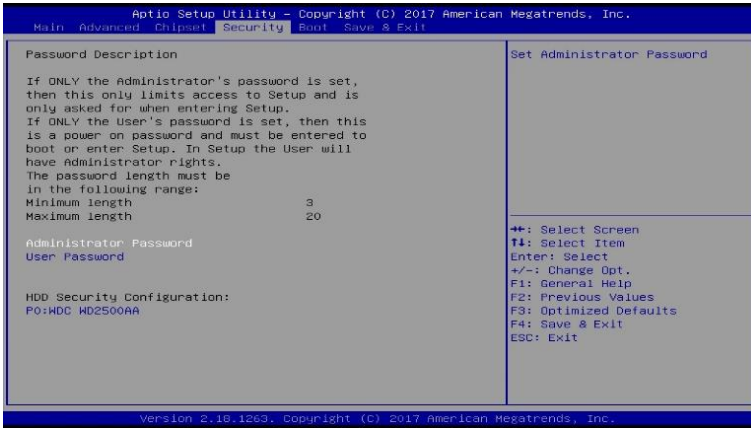

BIOS Setting	Description
Administrator Password	Sets an administrator password for the setup utility.
User Password	Sets a user password.

## 4.7 Boot Settings



BIOS Setting	Description
Setup Prompt Timeout	Number of seconds to wait for setup activation key. 65535 (0xFFFF) means indefinite waiting.
Bootup NumLock State	Selects the keyboard NumLock state.
Quiet Boot	Enables / Disables Quiet Boot option.
Fast Boot	Enables / Disables boot with initialization of a minimal set of devices required to launch active boot option. This has no effect for BBS boot options.
Boot mode select	Selects a Boot mode, Legacy / UEFI / Dual.
Boot Option Priorities	Sets the system boot order priorities for hard disk, CD/DVD, USB, Network.
Hard Disk Drive BBS Priorities	Specifies the Boot Device priority sequence from available hard disk drives.

## 4.8 Save & Exit Settings



BIOS Setting	Description
Save Changes and Exit	Exits system setup after saving the changes.
Discard Changes and Exit	Exits system setup without saving any changes.
Save Changes and Reset	Resets the system after saving the changes.
Discard Changes and Reset	Resets system setup without saving any changes.
Save Changes	Saves changes done so far to any of the setup options.
Discard Changes	Discards changes done so far to any of the setup options.
Restore Defaults	Restores / Loads defaults values for all the setup options.
Save as User Defaults	Saves the changes done so far as User Defaults.
Restore User Defaults	Restores the user defaults to all the setup options.

# Appendix

This section provides the mapping addresses of peripheral devices and the sample code of watchdog timer configuration.

## A. I/O Port Address Map

Each peripheral device in the system is assigned a set of I/O port addresses which also becomes the identity of the device. The following table lists the I/O port addresses used.

Address	Device Description
0x0000F140-0x0000F147	AMD SATA Controller
0x0000F130-0x0000F133	AMD SATA Controller
0x0000F120-0x0000F127	AMD SATA Controller
0x0000F110-0x0000F113	AMD SATA Controller
0x0000F100-0x0000F10F	AMD SATA Controller
0x00000020-0x00000021	Programmable interrupt controller
0x000000A0-0x000000A1	Programmable interrupt controller
0x0000F000-0x0000F0FF	AMD Radeon R7 Graphics
0x000003B0-0x000003BB	AMD Radeon R7 Graphics
0x000003B0-0x000003BB	PCI bus
0x000003C0-0x000003DF	AMD Radeon R7 Graphics
0x00000040-0x00000043	System timer
0x00000000-0x0000000F	Direct memory access controller
0x00000000-0x0000000F	PCI bus
0x00000081-0x00000083	Direct memory access controller
0x00000087-0x00000087	Direct memory access controller
0x00000089-0x0000008B	Direct memory access controller
0x0000008F-0x0000008F	Direct memory access controller
0x000000C0-0x000000DF	Direct memory access controller
0x00000060-0x00000060	Standard PS/2 Keyboard
0x00000064-0x00000064	Standard PS/2 Keyboard
0x000003F8-0x000003FF	Communications Port (COM1)
0x000002F8-0x000002FF	Communications Port (COM2)
0x000003E8-0x000003EF	Communications Port (COM3)

Address	Device Description
0x000002E8-0x000002EF	Communications Port (COM4)
0x00000238-0x0000023F	Communications Port (COM5)
0x00000338-0x0000033F	Communications Port (COM6)
0x00000061-0x00000061	System speaker
0x000003E0-0x00000CF7	PCI bus
0x00000D00-0x0000FFFF	PCI bus
0x0000E000-0x0000EFFF	PCI Express standard Root Port
0x00000070-0x00000071	System CMOS/real time clock
0x00000A00-0x00000A0F	Motherboard resources
0x00000A10-0x00000A1F	Motherboard resources
0x00000A20-0x00000A2F	Motherboard resources
0x00000A30-0x00000A3F	Motherboard resources
0x00000A40-0x00000A4F	Motherboard resources
0x0000D000-0x0000DFFF	PCI Express standard Root Port
0x00000010-0x0000001F	Motherboard resources
0x00000022-0x0000003F	Motherboard resources
0x00000063-0x00000063	Motherboard resources
0x00000065-0x00000065	Motherboard resources
0x00000067-0x0000006F	Motherboard resources
0x00000072-0x0000007F	Motherboard resources
0x00000080-0x00000080	Motherboard resources
0x00000084-0x00000086	Motherboard resources
0x00000088-0x00000088	Motherboard resources
0x0000008C-0x0000008E	Motherboard resources
0x00000090-0x0000009F	Motherboard resources
0x000000A2-0x000000BF	Motherboard resources
0x000000B1-0x000000B1	Motherboard resources
0x000000E0-0x000000EF	Motherboard resources
0x000004D0-0x000004D1	Motherboard resources

Address	Device Description
0x0000040B-0x0000040B	Motherboard resources
0x000004D6-0x000004D6	Motherboard resources
0x00000C00-0x00000C01	Motherboard resources
0x00000C14-0x00000C14	Motherboard resources
0x00000C50-0x00000C51	Motherboard resources
0x00000C52-0x00000C52	Motherboard resources
0x00000C6C-0x00000C6C	Motherboard resources
0x00000C6F-0x00000C6F	Motherboard resources
0x00000CD0-0x00000CD1	Motherboard resources
0x00000CD2-0x00000CD3	Motherboard resources
0x00000CD4-0x00000CD5	Motherboard resources
0x00000CD6-0x00000CD7	Motherboard resources
0x00000CD8-0x00000CDF	Motherboard resources
0x00000800-0x0000089F	Motherboard resources
0x00000B00-0x00000B0F	Motherboard resources
0x00000B20-0x00000B3F	Motherboard resources
0x00000900-0x0000090F	Motherboard resources
0x00000910-0x0000091F	Motherboard resources
0x0000FE00-0x0000FEFE	Motherboard resources

## B. Interrupt Request Lines (IRQ)

Peripheral devices use interrupt request lines to notify CPU for the service required. The following table shows the IRQ used by the devices on board.

Level	Function
IRQ 31	High Definition Audio Controller
IRQ 19	AMD SATA Controller
IRQ 81 ~ IRQ 190	Microsoft ACPI-Compliant System
IRQ 4294967292	AMD Radeon R7 Graphics
IRQ 4294967279	AMD PSP 2.0 Device
IRQ 4294967278	AMD PSP 2.0 Device
IRQ 18	Standard Enhanced PCI to USB Host Controller
IRQ 0	System timer
IRQ 0	High precision event timer
IRQ 8	High precision event timer
IRQ 46	High Definition Audio Controller
IRQ 1	Standard PS/2 Keyboard
IRQ 4	Communications Port (COM1)
IRQ 3	Communications Port (COM2)
IRQ 5	Communications Port (COM3)
IRQ 5	Communications Port (COM4)
IRQ 6	Communications Port (COM5)
IRQ 6	Communications Port (COM6)
IRQ 4294967270 ~ IRQ 4294967277	AMD USB 3.0 Host Controller
IRQ 4294967294	PCI Express standard Root Port
IRQ 4294967286 ~ IRQ 4294967291	Intel(R) I211 Gigabit Network Connection
IRQ 4294967293	PCI Express standard Root Port
IRQ 4294967280 ~ IRQ 4294967285	Intel(R) I211 Gigabit Network Connection #2
IRQ 12	Microsoft PS/2 Mouse

## C. Watchdog Timer Configuration

The Watchdog Timer (WDT) is used to generate a variety of output signals after a user programmable count. The WDT is suitable for use in the prevention of system lock-up, such as when software becomes trapped in a deadlock. Under these sorts of circumstances, the timer will count to zero and the selected outputs will be driven.

Under normal circumstance, you will need to restart the WDT at regular intervals before the timer counts to zero.

### 1. Sample Code: The file NCT6116D.H

```
//-----
//
// THIS CODE AND INFORMATION IS PROVIDED "AS IS" WITHOUT WARRANTY OF ANY
// KIND, EITHER EXPRESSED OR IMPLIED, INCLUDING BUT NOT LIMITED TO THE
// IMPLIED WARRANTIES OF MERCHANTABILITY AND/OR FITNESS FOR A PARTICULAR
// PURPOSE.
//
//-----
#ifndef __NCT6116D_H
#define __NCT6116D_H                                1
//-----
#define NCT6116D_INDEX_PORT      (NCT6116D_BASE)
#define NCT6116D_DATA_PORT      (NCT6116D_BASE+1)
//-----
#define NCT6116D_REG_LD          0x07
//-----
#define NCT6116D_UNLOCK          0x87
#define NCT6116D_LOCK            0xAA
//-----
unsigned int Init_NCT6116D(void);
void Set_NCT6116D_LD( unsigned char);
void Set_NCT6116D_Reg( unsigned char, unsigned char);
unsigned char Get_NCT6116D_Reg( unsigned char);
//-----
#endif      // __NCT6116D_H
```

## 2. Sample Code: The file MAIN.CPP

```

//-----
//
// THIS CODE AND INFORMATION IS PROVIDED "AS IS" WITHOUT WARRANTY OF ANY
// KIND, EITHER EXPRESSED OR IMPLIED, INCLUDING BUT NOT LIMITED TO THE
// IMPLIED WARRANTIES OF MERCHANTABILITY AND/OR FITNESS FOR A PARTICULAR
// PURPOSE.
//
//-----
#include <dos.h>
#include <conio.h>
#include <stdio.h>
#include <stdlib.h>
#include "NCT6116D.H"
//-----
int main (void);

void WDTInitial(void);
void WDTEnable(unsigned char);
void WDTDisable(void);

//-----
int main (void)
{
    char SIO;

    SIO = Init_NCT6116D();
    if (SIO == 0)
    {
        printf("Can not detect Nuvoton NCT6116D, program abort.\n");
        return(1);
    }

    WDTInitial();

    WDTEnable(10);

    WDTDisable();

    return 0;
}
//-----
void WDTInitial(void)
{
    unsigned char bBuf;
    Set_NCT6116D_LD(0x08); //switch
    to logic device 8
    bBuf = Get_NCT6116D_Reg(0x30);
    bBuf &= (~0x01);
    Set_NCT6116D_Reg(0x30, bBuf); //Enable
    WDTO
}
//-----

```

```
void WDTEnable(unsigned char NewInterval)
{
    unsigned char bBuf;

    Set_NCT6116D_LD(0x08); //switch
to logic device 8
    Set_NCT6116D_Reg(0x30, 0x01); //enable
timer

    bBuf = Get_NCT6116D_Reg(0xF0);
    bBuf &= (~0x08);
    Set_NCT6116D_Reg(0xF0, bBuf); //count
mode is second

    Set_NCT6116D_Reg(0xF1, NewInterval); //set timer
}
//-----
void WDTDisable(void)
{
    Set_NCT6116D_LD(0x08); //switch
to logic device 8
    Set_NCT6116D_Reg(0xF1, 0x00); //clear
watchdog timer
    Set_NCT6116D_Reg(0x30, 0x00);
//watchdog disabled
}
//-----
```

### 3. Sample Code: The file NCT6116D.CPP

```

//-----
//
// THIS CODE AND INFORMATION IS PROVIDED "AS IS" WITHOUT WARRANTY OF ANY
// KIND, EITHER EXPRESSED OR IMPLIED, INCLUDING BUT NOT LIMITED TO THE
// IMPLIED WARRANTIES OF MERCHANTABILITY AND/OR FITNESS FOR A PARTICULAR
// PURPOSE.
//
//-----
#include "NCT6116D.H"
#include <dos.h>
//-----
unsigned int NCT6116D_BASE;
void Unlock_NCT6116D (void);
void Lock_NCT6116D (void);
//-----
unsigned int Init_NCT6116D(void)
{
    unsigned int result;
    unsigned char ucDid;

    NCT6116D_BASE = 0x4E;
    result = NCT6116D_BASE;

    ucDid = Get_NCT6116D_Reg(0x20);
    if (ucDid == 0xC4)
        //NCT6116D??
        {           goto Init_Finish;           }

    NCT6116D_BASE = 0x2E;
    result = NCT6116D_BASE;

    ucDid = Get_NCT6116D_Reg(0x20);
    if (ucDid == 0xC4)
        //NCT6116D??
        {           goto Init_Finish;           }

    NCT6116D_BASE = 0x00;
    result = NCT6116D_BASE;

Init_Finish:
    return (result);
}
//-----
void Unlock_NCT6116D (void)
{
    outportb(NCT6116D_INDEX_PORT, NCT6116D_UNLOCK);
    outportb(NCT6116D_INDEX_PORT, NCT6116D_UNLOCK);
}
//-----

```

```
void Lock_NCT6116D (void)
{
    outportb(NCT6116D_INDEX_PORT, NCT6116D_LOCK);
}
//-----
void Set_NCT6116D_LD( unsigned char LD)
{
    Unlock_NCT6116D();
    outportb(NCT6116D_INDEX_PORT, NCT6116D_REG_LD);
    outportb(NCT6116D_DATA_PORT, LD);
    Lock_NCT6116D();
}
//-----
void Set_NCT6116D_Reg( unsigned char REG, unsigned char DATA)
{
    Unlock_NCT6116D();
    outportb(NCT6116D_INDEX_PORT, REG);
    outportb(NCT6116D_DATA_PORT, DATA);
    Lock_NCT6116D();
}
//-----
unsigned char Get_NCT6116D_Reg(unsigned char REG)
{
    unsigned char Result;
    Unlock_NCT6116D();
    outportb(NCT6116D_INDEX_PORT, REG);
    Result = inportb(NCT6116D_DATA_PORT);
    Lock_NCT6116D();
    return Result;
}
//-----
```

## D. On-Board Connector Types

Function	Connector Name	Type
eDP Connector	CN1	AE_FI-TD44SB-E-R750
ATX Power Supply Connector	J13	HK_01-0001-32
DC Power Input Connector	J14	HK_ATX4PT-NY46
Digital I/O Connector	J12	E-CALL_0126-01-203-100
COM1 RS-232/422/485 & COM2 RS-232 Ports	CN2	YIMTEX_409S09PAANSNIR
COM3 & COM4 RS-232 Ports	CN3	YIMTEX_409S09PAANSNIR
COM5 & COM6 RS-232 Port	J16 (COM5), J17 (COM6)	HK_DF11-10S-PA66H
Fan Power Connector	CPU_FAN1	TECHBEST_W2-031104132S1WT(A)-L
Fan Power Connector	SYS_FAN1, SYS_FAN2	E-CALL_0110-02-111-030
Front Panel Setting Connector	J3	E-CALL_0126-01-203-080
HDD Power Connector	J9, J11	HK_W7-03H104142S1WT
USB 2.0 Connector	J10	HK_DF11-8S-PA66H
LCD Backlight Connector	J18	E-CALL_0110-161-040
Speaker Connector	J19	JST_B4B-PH-K-S
LVDS Connector	J20 (2 <sup>nd</sup> Ch.), J21 (1 <sup>st</sup> Ch.)	Hirose DF20G-20DP-1V
Audio Connector	J22	E-CALL_0126-01-2821009