

IB897

**Intel® Atom™ E3800 SoC Series
3.5" Disk Size SBC**

USER'S MANUAL

Version 1.0

Acknowledgments

AMI BIOS is a trademark of American Megatrends Inc.

PS/2 is a trademark of International Business Machines Corporation.

Intel and Atom are registered trademarks of Intel Corporation.

Microsoft Windows is a registered trademark of Microsoft Corporation.

Nuvoton is a registered trademark of Winbond Electronics Corporation.

All other product names or trademarks are properties of their respective owners.

Table of Contents

Introduction	1
Product Description.....	1
Specifications	2
Checklist.....	3
Board Dimensions for [IB897-I45/I27/I15].....	4
Board Dimensions for [IB897-I45P/I27P/I15P]	4
Installations	5
Installing the Memory	6
Setting the Jumpers	7
Connectors on IB897.....	11
BIOS Setup	27
Drivers Installation	43
Intel Chipset Software Installation Utility	44
VGA Drivers Installation	45
Realtek High Definition Audio Driver Installation.....	46
Intel Trusted Execution Engine Installation.....	47
Appendix.....	49
A. I/O Port Address Map	49
B. Interrupt Request Lines (IRQ).....	50
C. Digital I/O Sample Code	51
D. Watchdog Timer Configuration	56

This page is intentionally left blank.

Introduction

Product Description

IB897 is a 3.5-inch single board computer based on the Intel® Atom™ E3800 series processors. It supports two DDR3L (1.35V) SODIMM sockets for a maximum memory capacity of 8GB.

IB897 features the Intel® Gen7 w/4EUs graphics engines and has both CRT and DisplayPort video display interface, and 24-bit LVDS dual channel interface with the use of the NXP PTN3460 device.

Onboard connections are available for two SATAII ports, two COM ports, one USB 3.0 ports, four USB2.0 ports, audio, two Mini PCI-e(x1) slots, and Micro SD. Power input is made with a +9~+30V DC in interface.

IB897 Features:

- Supports Atom™ E3800 series SoC processors
- Two DDR3L SO-DIMM, 1066/1333 MHz, Max. 8GB memory
- Integrated graphics for VGA, DP displays
- 2 x SATA II connectors
- 2x COM port connectors
- 1 x Mini-PCIe(x1) slot (*w/ USB/mSATA support*)
- 1 x Mini-PCIe(x1) slot (*w/ USB support*)
- 2x GbE (RJ-45) connectors
- 24-bit dual channel LVDS
- Micro SD
- 1x 9V to 30V DC-in power connector

Specifications

Product Name	IB897
Form Factor	3.5" disk size SBC
SoC Type/Speed	Intel® Atom™ QC E3845 /2MB cache/1.91GHz (IB897-I45&I45P) Intel® Atom™ DC E3827 /1MB cache/1.75 GHz (IB897-I27&I27P) Intel® Atom™ SC E3815 /512KB cache/1.46 GHz (IB897-I15& I15P) Package = FCBGA1170, 25mmx27mm, 22nm,Tj= -40° C to +110° C
BIOS	AMI BIOS
Memory	Intel® Atom™ SoC integrated memory controller Support DDR3L (1.35V only), Non-ECC memory only 2 x DDR3 SO-DIMM socket [IB897-I45_P/IB897-I27_P], 8GB max. 1 x DDR3 SO-DIMM socket [IB897-I15_P], 4GB max.
VGA	Intel® Gen7 w/4 EUs graphics engines DisplayPort x 1 [Support to 2560x1200@60Hz] CRT x 1 via pin header [Support to 1920x1080@60Hz]
LVDS	24-bit dual channel via NXP PTN3460 thru eDP (Support to 1920x1200 @ 60 Hz)
LAN	Intel® I210IT PCIe Gigabit LAN x 2
USB	Intel® Atom™ SoC built-in USB host controller Support USB 2.0 x 4 ports; USB 3.0 x 1 port, extra USB 2.0 x4 ports (Thru SMC HUB USB2514)
Serial ATA	Intel® Atom™ SoC built-in SATA II controller, supports 2 ports
Audio	Intel® Atom™ SoC built-in HD Audio controller + Realtek ALC269QHD Codec w/class-D speaker amplifier (2.3W per channel @ 5V power supply) [7mm x 7mm @ 48-QFN]; support 2-channel audio out + amp
LPC I/O	Nuvoton NCT5523D [64-pin LQFP, 7x7x1.4mm] - COM #1 (RS232/422/485) [EXAR SP339EER1 x 1 for jumper-less] - COM #2 (RS-232 only) [Hardware Monitor]: 2x Thermal inputs; 2x Voltage monitoring
Digital IO	4 in & 4 out
Expansion Slots	Mini PCI-e socket x2 (1xFull-sized+1xHalf-sized,) **Full length MiniPCIe (1x) support mSATA**
Edge Connector	DB9 for COM1, DisplayPort, RJ45 x 2 for LAN 1 & 2 USB 2.0 vertical connector x 1, USB 3.0 vertical connector x 1 LED indicators (red+green) x1 for power and HDD status & power button x 1 (IB897-I45/I27/I15) 4-pin header for LED indicator & 2-pin header for power button via cable (IB897-I45P/I27P/I15P)
Onboard Header/ Connector	2x8 pin header for CRT; 2x4 pin header for 2x USB 2.0 DF20 socket connector x2 for 24-bit dual channel LVDS 4-pin box header for backlight/brightness control (PWM) 2x6 pin box header for Audio, 4-pin header for speaker 2x5 pin box header for COM2 2x5 pin headers for LPC (80-port card debugging purpose) Mini PCI-e(1x) connector x2, 5 pins box header for smart battery SATA connector x 2 for SATA device 4-pins power connector (JST type, for SATA device) 2-pins connector for power input, Micro SD slot (type 3.3V)
Watchdog	Yes (256 segments, 0, 1, 2...255 sec/min)
Power Connector	9V ~ 30V DC-in thru onboard 2-pin connector
Others	iSMART [Auto-scheduler / Power resume]
OS Support	Windows 8.1 / Embedded; Windows 7 / Embedded, Linux
RoHS / REACH/ CE / FCC	Yes / Yes / Yes / Class B
Operating Temp.	-40° C to +85° C
Board Size	102mm x 147mm

Checklist

Your IB897 package should include the items listed below.

- The IB897 SBC
- This User's Manual
- 1 CD containing chipset drivers and flash memory utility

INTRODUCTION

Board Dimensions for [IB897-I45/I27/I15]

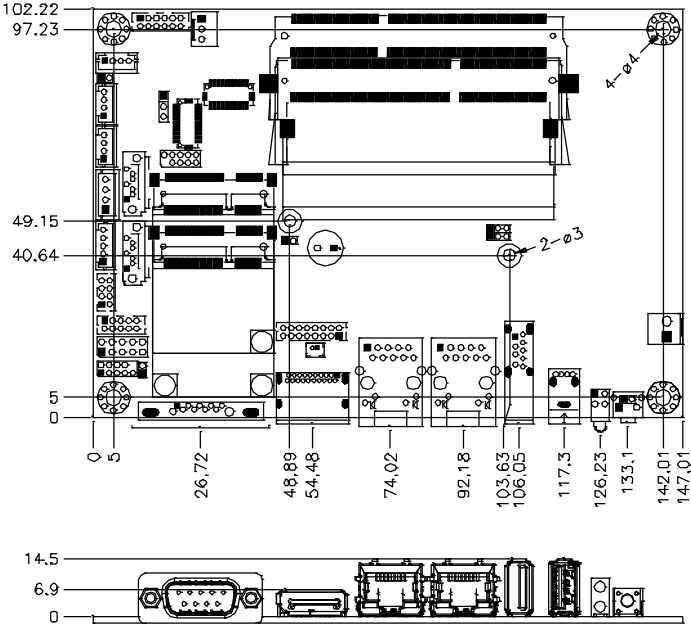

Board Dimensions for [IB897-I45P/I27P/I15P]

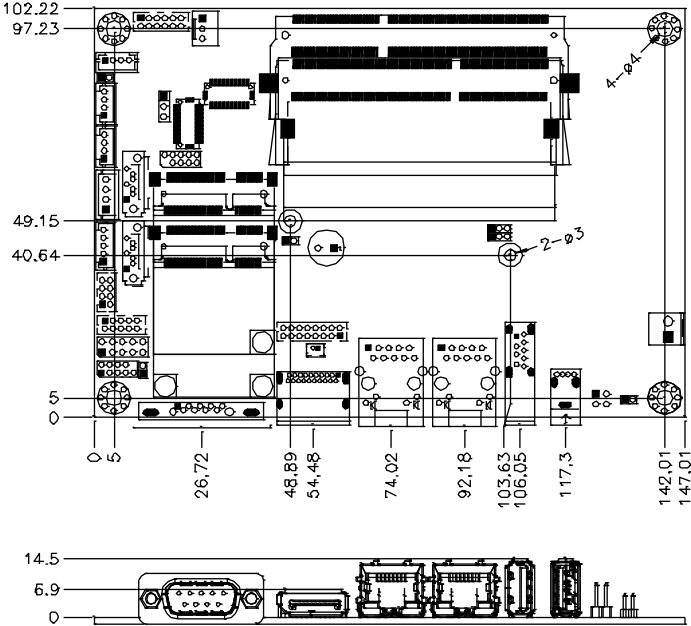

Installations

This section provides information on how to use the jumpers and connectors on the IB897 in order to set up a workable system. The topics covered are:

Installing the Memory	6
Setting the Jumpers	7
Connectors on IB897	11

Installing the Memory

The IB897 board supports TWO DDR3L memory socket for a maximum total memory of 8GB DDR3L memory type.

Installing and Removing Memory Modules

To install the DDR3L modules, locate the memory slot on the board and perform the following steps:

1. Hold the DDR3L module so that the key of the DDR3L module aligned with that on the memory slot.
2. Gently push the DDR3L module in an upright position until the clips of the slot close to hold the DDR3L module in place when the DDR3L module touches the bottom of the slot.
3. To remove the DDR3L module, press the clips with both hands.

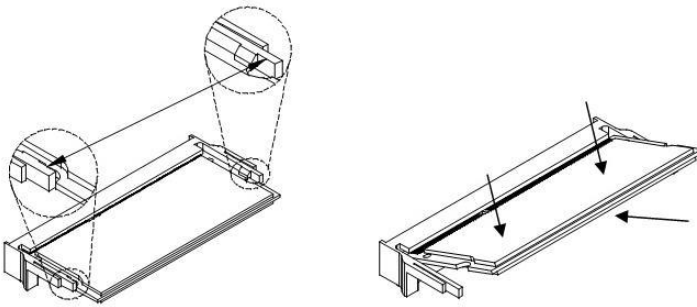

**** Channel-A slot must be installed with memory module for booting up****

Setting the Jumpers

Jumpers are used on IB897 to select various settings and features according to your needs and applications. Contact your supplier if you have doubts about the best configuration for your needs. The following lists the connectors on IB897 and their respective functions.

Jumper Locations on IB897	8
JP2: LVDS Panel Brightness Control Selection	9
J5: LVDS Panel Power Selection	9
JP5: Clear ME Contents.....	10
JP6: Clear CMOS Contents	10

INSTALLATIONS

Jumper Locations on IB897

[IB897-I45/I27/I15]

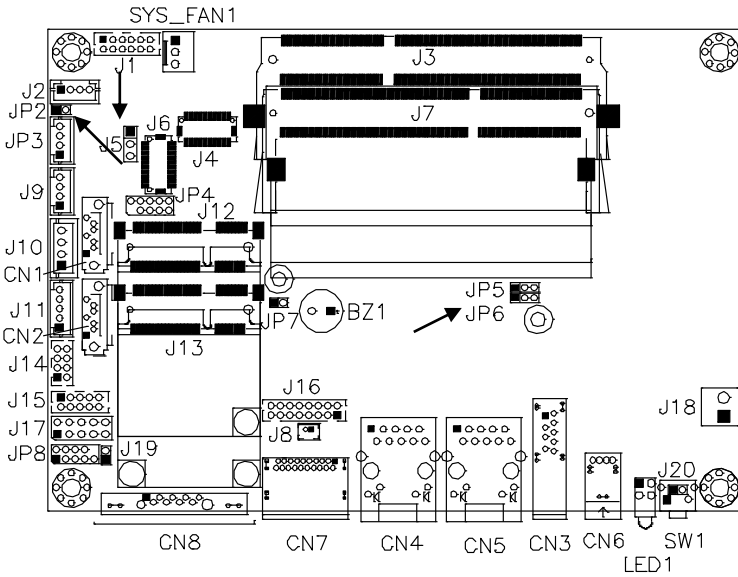

[IB897-I45P/I27P/I15P]

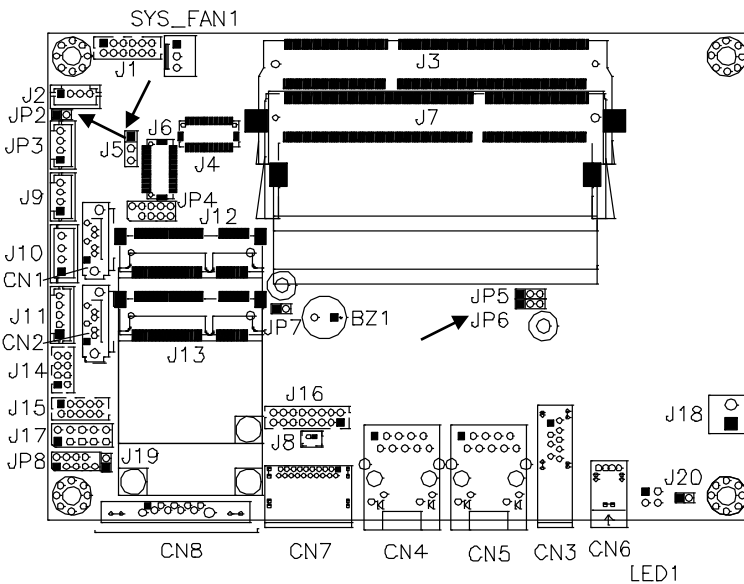

JP2: LVDS Panel Brightness Control Selection

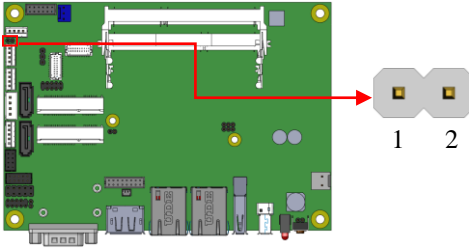

JP2	Brightness Control (PWM mode)
Open	3.3V
Close	5V(Default)

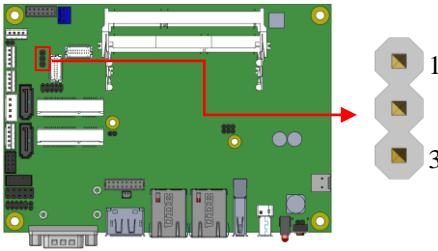

J5: LVDS Panel Power Selection



J5	Setting	Panel Voltage
<p>1 2 3</p>	Pin 1-2 Short/Closed	3.3V (default)
<p>1 2 3</p>	Pin 2-3 Short/Closed	5V

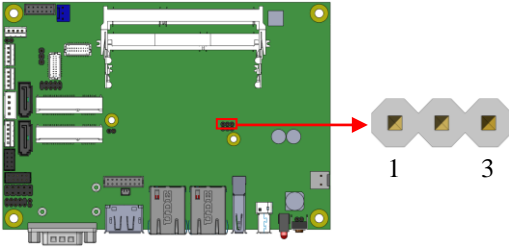

JP5: Clear ME Contents

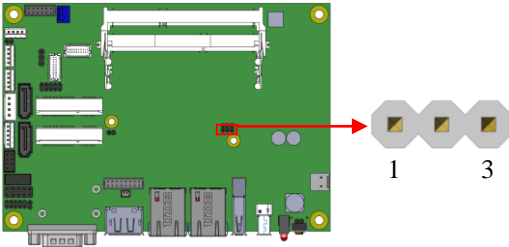

JP5	Setting	Function
 1 2 3	Pin 1-2 Short/Closed	Normal
 1 2 3	Pin 2-3 Short/Closed	Clear ME REGISTER

JP6: Clear CMOS Contents



JP6	Setting	Function
 1 2 3	Pin 1-2 Short/Closed	Normal
 1 2 3	Pin 2-3 Short/Closed	Clear CMOS

Connectors on IB897

Connector Locations on IB897-I45/I27/I15	12
Connector Locations on IB897-I45P/I27P/I15P	12
CN3: USB3.0 Connector	13
CN4, CN5: Gigabit LAN Connector.....	13
CN4: Intel® I210IT Connector.....	13
CN5: Intel® I210IT Connector.....	13
CN6: USB2.0 Connector	13
CN7: DP Connector.....	13
CN8: DB9 Connector (COM1).....	14
CN9: Micro SD (3.3V) Connector.....	14
SW1: Power Switch [For IB897-I45/I27/I15]	14
LED1: Power LED and HDD LED Connector [For IB897-I45/I27/I15]	15
CN1: SATAII /share mSATA/ Connectors.....	16
CN2: SATAII Connectors	16
SYS_FAN1: SYSTEM Fan Power Connector.....	16
J1: Audio Connector (DF11-12DP-2DSA).....	17
J2: Amplify Connector (JST B4B-PH-K-S)	17
J7: DDR3L SO-DIMM(CH-A) Sockets	17
J3: DDR3L SO-DIMM(CH-B) Sockets.....	18
J4, J6: LVDS Connectors, (DF20G-20DP-1V)	18
J4: First Channel LVDS.....	18
J6: Second Channel LVDS	18
J9: MCU Flash Connector (factory use only)	19
J10: SATA HDD Power Connectors(JST B4B-XH-A)	19
J11: Smart Battery(JST B5B-PH-K-S)	20
J12: Mini PCIE Connector (share mSATA)	20
J13: Mini PCIE Connector (Half Size)	20
J14: USB 2.0 Connector(DF11-8DP-2DSA).....	21
J15: COM2/RS232 Serial Port(DF11-10DP-2DSA)	21
J16: VGA Connector (DF11-16DP-2DSA).....	22
J17: Digital I/O Connector(2.54mm).....	22
J18: Board Input Power Connector(HK_WAFER396-2S-WV)	23
J19: Reset Switch(2mm).....	23
J20: Power Switch(2mm).....	23
JP3: LCD Backlight Connector(JST B4B-PH-K-S).....	24
JP4: SPI Flash Connector (factory use only)	25
JP7: Factory use only.....	25
JP8: Debug 80 Port Connector (factory use only)	25

Connector Locations on IB897-I45/I27/I15

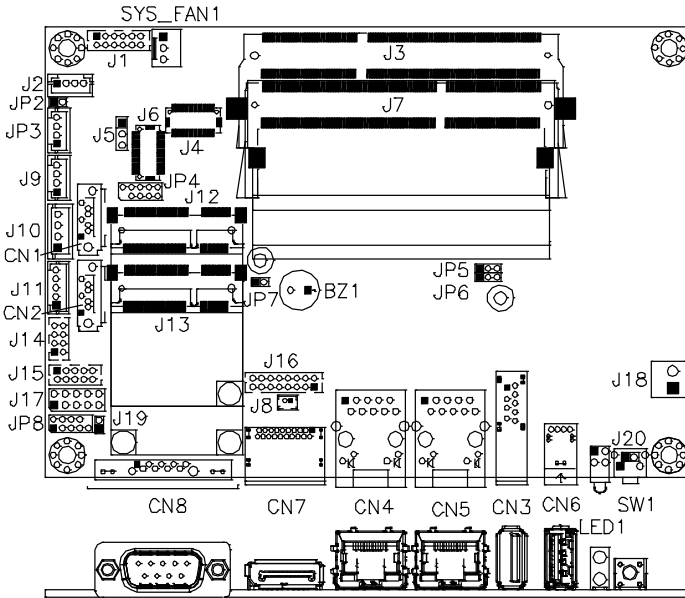

Connector Locations on IB897-I45P/I27P/I15P

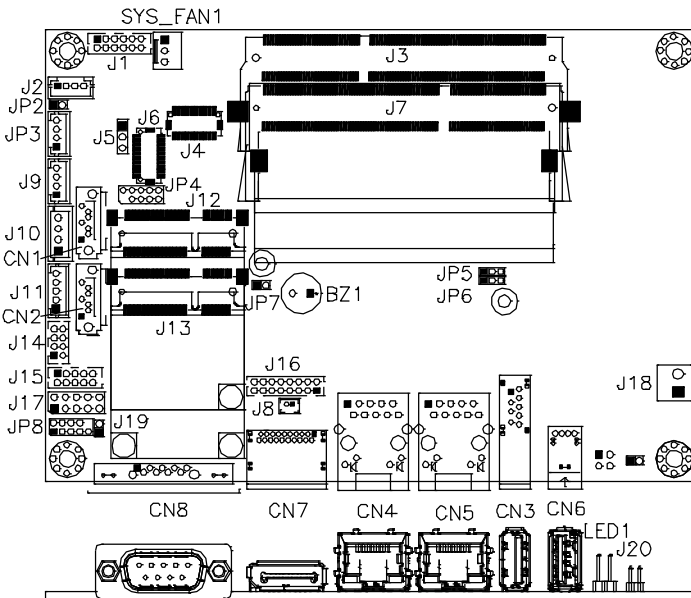

Bottom side

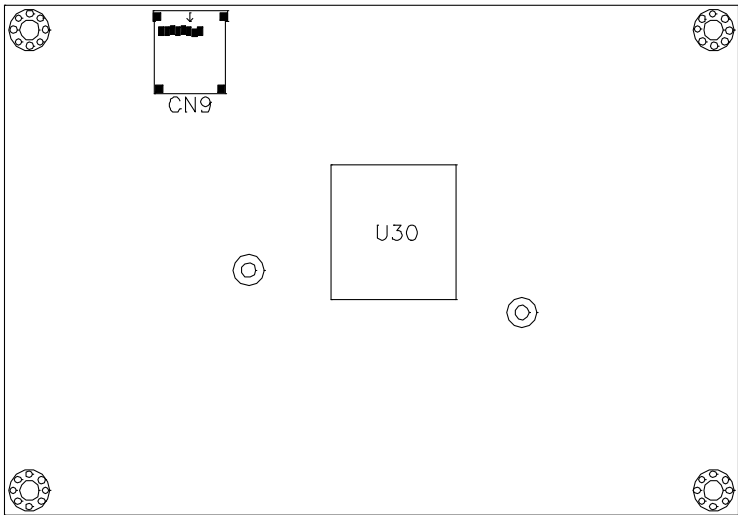
**CN3: USB3.0 Connector****CN4, CN5: Gigabit LAN Connector****CN4: Intel® I210IT Connector****CN5: Intel® I210IT Connector****CN6: USB2.0 Connector****CN7: DP Connector**

INSTALLATIONS

CN8: DB9 Connector (COM1)

Signal Name	Pin #	Pin #	Signal Name
DCD, Data carrier detect	1	6	DSR, Data set ready
RXD, Receive data	2	7	RTS, Request to send
TXD, Transmit data	3	8	CTS, Clear to send
DTR, Data terminal ready	4	9	RI, Ring indicator
GND, ground	5	10	Not Used

COM1 is jumper-less for RS-232, RS-422 and RS-485 and is to be configured with BIOS Selection.

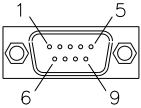

Pin #	Signal Name		
	RS-232	R2-422	RS-485
1	DCD	TX-	DATA-
2	RX	TX+	DATA+
3	TX	RX+	NC
4	DTR	RX-	NC
5	Ground	Ground	Ground
6	DSR	NC	NC
7	RTS	NC	NC
8	CTS	NC	NC
9	RI	NC	NC
10	NC	NC	NC

CN9: Micro SD (3.3V) Connector

SW1: Power Switch [For IB897-I45/I27/I15]

LED1:**Power LED and HDD LED Connector [For IB897-I45/I27/I15]
2x2 Pin-header (2.54mm) [For IB897-I45P/I27P/I15P]**

The green LED at the bottom is power LED. The red LED on top is the HDD LED.

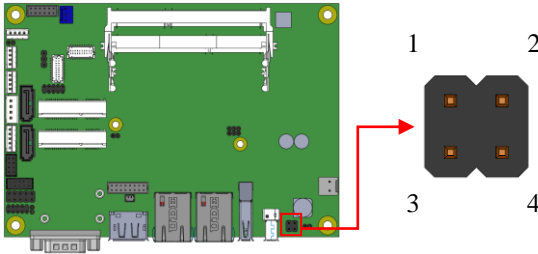

Signal Name	Pin #	Pin #	Signal Name
VCC3	1	2	HDD_LED
VCC5	3	4	GND

INSTALLATIONS

CN1: SATAII /share mSATA/ Connectors

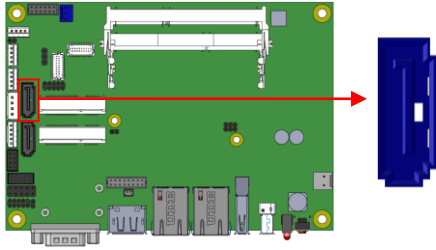

CN2: SATAII Connectors

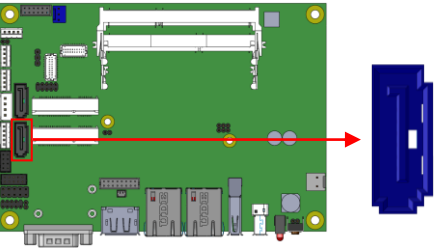

SYS_FAN1: SYSTEM Fan Power Connector

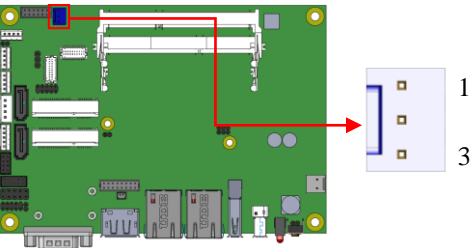

Pin #	Signal Name
1	Ground
2	+12V(500mA)
3	Rotation detection

J1: Audio Connector (DF11-12DP-2DSA)

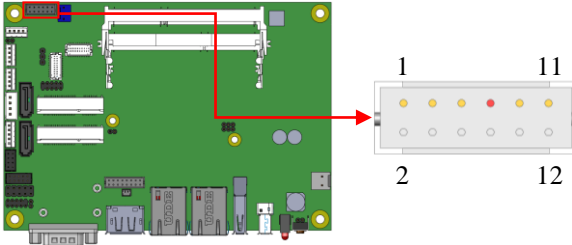

Signal Name	Pin #	Pin #	Signal Name
LINEOUT_R	2	1	LINEOUT_L
Ground	4	3	JD_FRONT
LINEIN_R	6	5	LINEIN_L
Ground	8	7	JD_LINEIN
MIC-R	10	9	MIC_L
Ground	12	11	JD_MIC1

J2: Amplify Connector (JST B4B-PH-K-S)

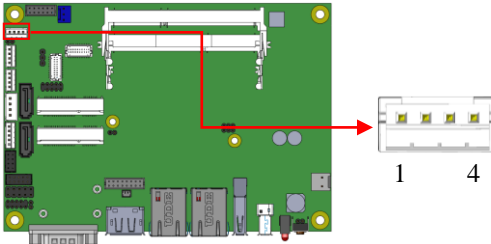

Pin #	Signal Name
1	OUTL+
2	OUTL-
3	OUTR-
4	OUTR+

J7: DDR3L SO-DIMM(CH-A) Sockets

**** Please note CH-A must be installed for booting up****

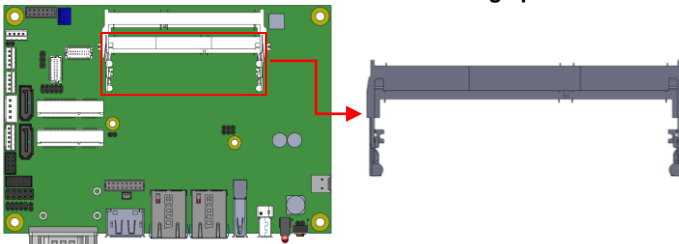

J3: DDR3L SO-DIMM(CH-B) Sockets

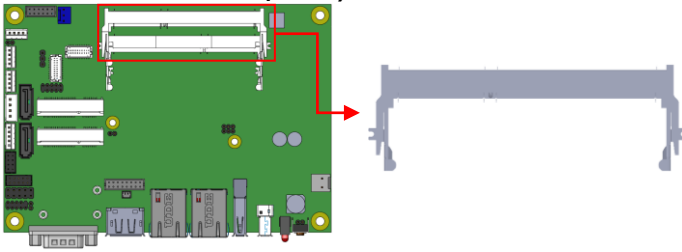

J4, J6: LVDS Connectors, (DF20G-20DP-1V)

J4: First Channel LVDS

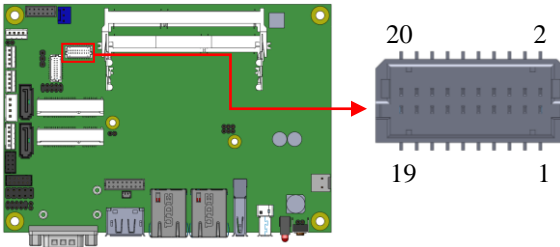

J6: Second Channel LVDS

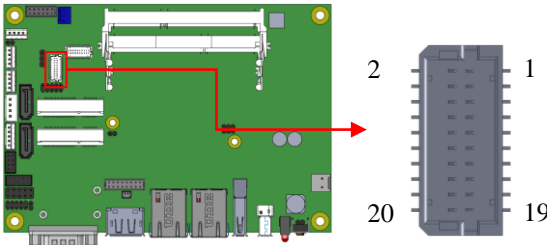

Signal Name	Pin #	Pin #	Signal Name
TX0N	2	1	TX0P
Ground	4	3	Ground
TX1N	6	5	TX1P
Ground	8	7	Ground
TX2N	10	9	TX2P
Ground	12	11	Ground
CLKN	14	13	CLKP
Ground	16	15	Ground
TX3N	18	17	TX3P
Power(1A)	20	19	Power

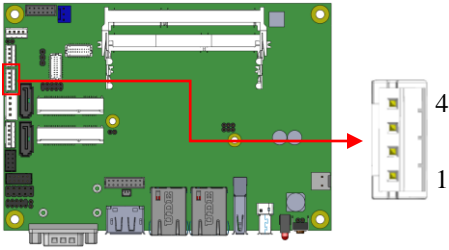
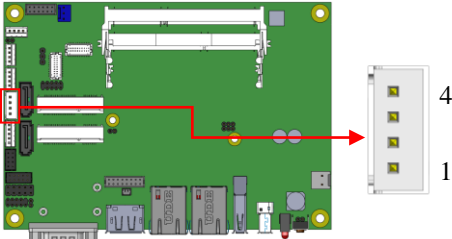
J9: MCU Flash Connector (factory use only)**J10: SATA HDD Power Connectors(JST B4B-XH-A)**

Pin #	Signal Name
1	+5V(1A)
2	Ground
3	Ground
4	+12V(1A)

INSTALLATIONS

J11: Smart Battery(JST B5B-PH-K-S)

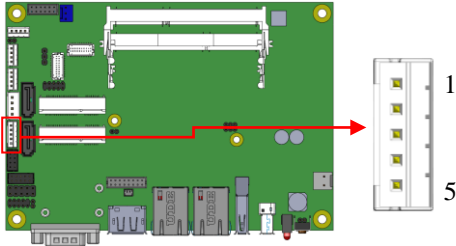

Pin #	Signal Name
1	RST#
2	ICHSWI#
3	Ground
4	SMB_DATA
5	SMB_CLK

J12: Mini PCIE Connector (share mSATA)

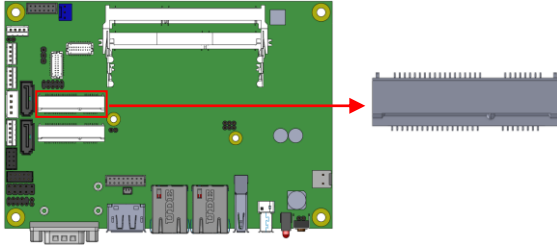

J13: Mini PCIE Connector (Half Size)

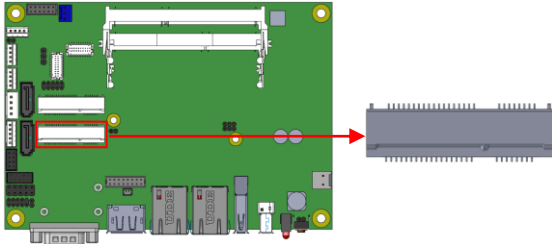

J14: USB 2.0 Connector(DF11-8DP-2DSA)

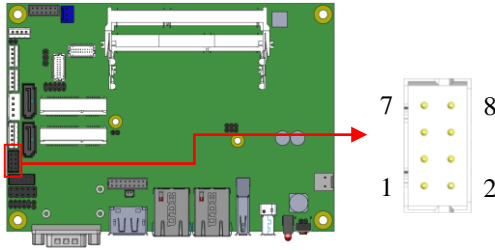

Signal Name	Pin #	Pin #	Signal Name
Vcc	1	2	Ground
D0-	3	4	D1+
D0+	5	6	D1-
Ground	7	8	Vcc

J15: COM2/RS232 Serial Port(DF11-10DP-2DSA)

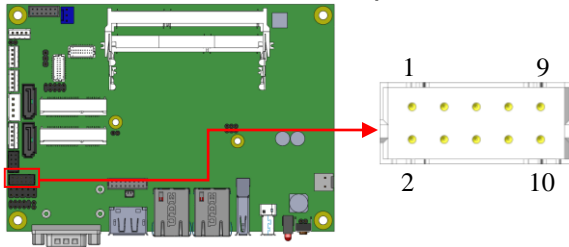

Signal Name	Pin #	Pin #	Signal Name
DCD, Data carrier detect	1	2	RXD, Receive data
TXD, Transmit data	3	4	Data terminal ready
GND, ground	5	6	DSR, Data set ready
RTS, Request to send	7	8	CTS, Clear to send
RI, Ring indicator	9	10	Not Used

J16: VGA Connector (DF11-16DP-2DSA)

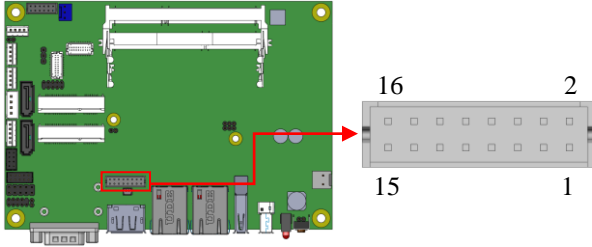

Signal Name	Pin #	Pin #	Signal Name
+5V	2	1	Red
Ground	4	3	Green
N.C	6	5	Blue
DDCDATA	8	7	N.C
H_SYNC	10	9	GND
V_SYNC	12	11	GND
DDCCLK	14	13	GND
N.C.	16	15	GND

J17: Digital I/O(signal level 5V)Connector(2.54mm)

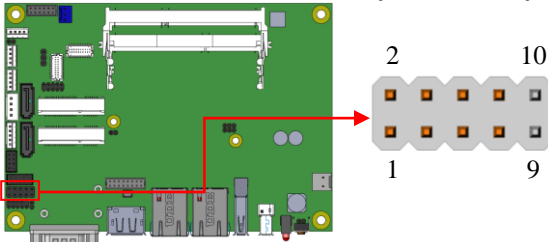

Signal Name	Pin #	Pin #	Signal Name
GND	1	2	VCC(500mA)
OUT3	3	4	OUT1
OUT2	5	6	OUT0
IN3	7	8	IN1
IN2	9	10	IN0

J18: Board Input Power Connector(HK_WAFER396-2S-WV)

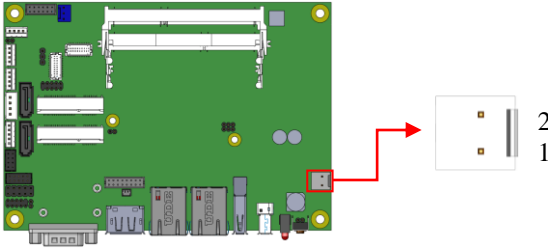

Pin #	Signal Name
1	+9V to +30V(10A)
2	GND

J19: Reset Switch(2mm)

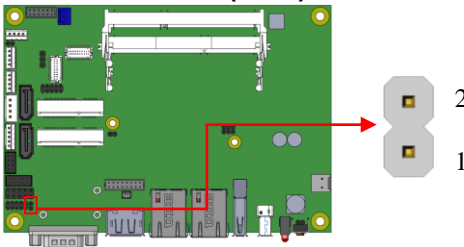

Pin #	Signal Name
1	Reset Switch
2	Ground

J20: Power Switch(2mm)

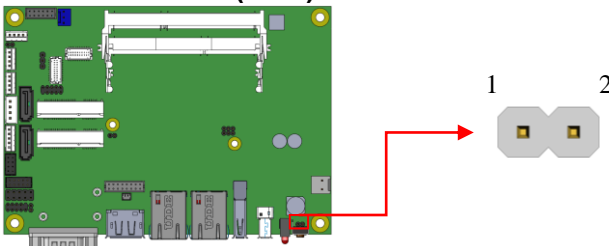

Pin #	Signal Name
1	Power Switch
2	Ground

INSTALLATIONS

JP3: LCD Backlight Connector(JST B4B-PH-K-S)

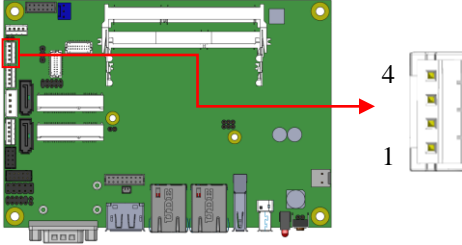

Pin #	Signal Name
1	+12V(1A)
2	Backlight Enable
3	Brightness Control
4	Ground

JP4: SPI Flash Connector (factory use only)

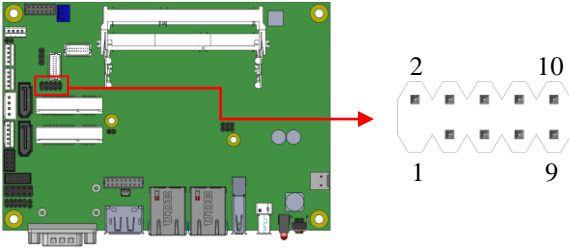

JP7: Factory use only

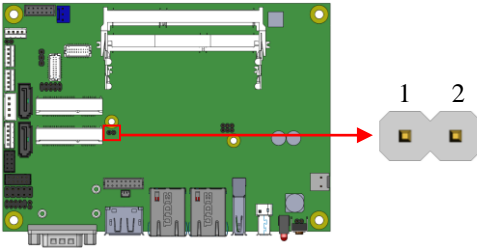

JP8: Debug 80 Port Connector (factory use only)

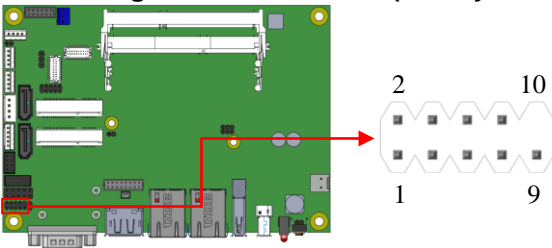

This page is intentionally left blank.

BIOS Setup

This chapter describes the different settings available in the AMI BIOS that comes with the board. The topics covered in this chapter are as follows:

BIOS Introduction	28
BIOS Setup	28
Main Settings	26
Advanced Settings	30
Chipset Settings	38
Security Settings	39
Boot Settings.....	40
Save & Exit Settings.....	41
Additional Information about OS Installation.....	34

BIOS Introduction

The BIOS (Basic Input/Output System) installed in your computer system's ROM supports Intel processors. The BIOS provides critical low-level support for a standard device such as disk drives, serial ports and parallel ports. It also provides password protection as well as special support for detailed fine-tuning of the chipset controlling the entire system.

BIOS Setup

The BIOS provides a Setup utility program for specifying the system configurations and settings. The BIOS ROM of the system stores the Setup utility. When you turn on the computer, the BIOS is immediately activated. Pressing the key immediately allows you to enter the Setup utility. If you are a little bit late pressing the key, POST (Power On Self Test) will continue with its test routines, thus preventing you from invoking the Setup. If you still wish to enter Setup, restart the system by pressing the "Reset" button or simultaneously pressing the <Ctrl>, <Alt> and <Delete> keys. You can also restart by turning the system Off and back On again. The following message will appear on the screen:

Press to Enter Setup

In general, you press the arrow keys to highlight items, <Enter> to select, the <PgUp> and <PgDn> keys to change entries, <F1> for help and <Esc> to quit.

When you enter the Setup utility, the Main Menu screen will appear on the screen. The Main Menu allows you to select from various setup functions and exit choices.

Warning: *It is strongly recommended that you avoid making any changes to the chipset defaults. These defaults have been carefully chosen by both AMI and your system manufacturer to provide the absolute maximum performance and reliability. Changing the defaults could cause the system to become unstable and crash in some cases.*

Main Settings

Aptio Setup Utility – Copyright © 2013 American Megatrends, Inc.

Main	Advanced	Chipset	Boot	Security	Save & Exit
BIOS Information				Choose the system default language	
System Language			[English]		→ ← Select Screen
System Date			[Tue 01/20/2009]		↑ ↓ Select Item
System Time			[21:52:06]		Enter: Select
Access Level			Administrator		+ - Change Field
					F1: General Help
					F2: Previous Values
					F3: Optimized Default
					F4: Save ESC: Exit

System Language

Choose the system default language.

System Date

Set the Date. Use Tab to switch between Data elements.

System Time

Set the Time. Use Tab to switch between Data elements.

Advanced Settings

This section allows you to configure and improve your system and allows you to set up some system features according to your preference.

Aptio Setup Utility – Copyright © 2013 American Megatrends, Inc.

Main	Advanced	Chipset	Boot	Security	Save & Exit
	<ul style="list-style-type: none"> ▶ ACPI Settings ▶ LVDS Configuration ▶ iSmart Controller ▶ Super IO Configuration ▶ H/W Monitor ▶ CPU Configuration ▶ PPM Configuration ▶ IDE Configuration ▶ SDIO Configuration 				→ ←Select Screen ↑ ↓ Select Item Enter: Select +- Change Opt. F1: General Help F2: Previous Values F3: Optimized Defaults F4: Save & Exit ESC: Exit

ACPI Settings

Aptio Setup Utility – Copyright © 2013 American Megatrends, Inc.

Main	Advanced	Chipset	Boot	Security	Save & Exit
	ACPI Settings				
	Enable ACPI Auto Configuration		Disabled		→ ←Select Screen ↑ ↓ Select Item Enter: Select +- Change Opt. F1: General Help F2: Previous Values F3: Optimized Defaults F4: Save & Exit ESC: Exit
	Enable Hibernation		Enabled		
	ACPI Sleep State		S3 only (Suspend to ...)		

Enabled ACPI Auto Configuration

Enables or Disables BIOS ACPI Auto Configuration.

Enable Hibernation

Enables or Disables System ability to Hibernate (OS/S4 Sleep State). This option may be not effective with some OS.

ACPI Sleep State

Select ACPI sleep state the system will enter when the SUSPEND button is pressed.

LVDS Configuration

Aptio Setup Utility – Copyright © 2013 American Megatrends, Inc.

Main	Advanced	Chipset	Boot	Security	Save & Exit
Configuration					→ ←Select Screen ↑ ↓ Select Item Enter: Select +- Change Opt. F1: General Help F2: Previous Values F3: Optimized Defaults F4: Save & Exit ESC: Exit
Panel Color Depth		24 BIT			
LVDS Channel Type		Single			
Panel Type		1024 x 768			
LVDS Backlight Control		0(Min)			

iSmart Controller

Aptio Setup Utility – Copyright © 2013 American Megatrends, Inc.

Main	Advanced	Chipset	Boot	Security	Save & Exit
iSmart Controller					→ ←Select Screen ↑ ↓ Select Item Enter: Select +- Change Opt. F1: General Help F2: Previous Values F3: Optimized Defaults F4: Save & Exit ESC: Exit
Power-On after Power failure		Disable			
Schedule Slot 1		None			
Schedule Slot 2		None			

Power-On after Power failure

This field sets the system power status whether *Disable* or *Enable* when power returns to the system from a power failure situation.

Schedule Slot 1 / 2

Setup the hour/minute for system power on.

Super IO Configuration

Aptio Setup Utility - Copyright © 2013 American Megatrends, Inc.

Main	Advanced	Chipset	Boot	Security	Save & Exit
Super IO Configuration				→ ← Select Screen ↑ ↓ Select Item Enter: Select +- Change Opt. F1: General Help F2: Previous Values F3: Optimized Defaults F4: Save & Exit ESC: Exit	
▶ Serial Port 1 Configuration					
▶ Serial Port 2 Configuration					

Serial Port 1 Configuration

Set parameters of serial port 1(COMA)

Serial Port 2 Configuration

Set parameters of serial port 2(COMA)

H/W Monitor

Aptio Setup Utility – Copyright © 2013 American Megatrends, Inc.

Main	Advanced	Chipset	Boot	Security	Save & Exit
PC Health Status			Disabled		
Smart Fan Function			Disabled		
SYS temp			+33.0 C		
CPU temp			+34.5 C		
FAN1 Speed			4066 RPM		→ ← Select Screen
Vcore			+1.704 V		↑ ↓ Select Item
+1.35V			+1.544 V		Enter: Select
AVCC			+3.360 V		+ - Change Opt.
USB3			+3.344 V		F1: General Help
VCC3V			+3.328 V		F2: Previous Values
					F3: Optimized Defaults
					F4: Save & Exit
CPU Shutdown Temperature			Disabled		ESC: Exit

Smart Fan Function

This field enables or disables the smart fan feature.

Disabled (default)

- 50 °C
- 60 °C
- 70 °C
- 80 °C
- 90 °C

Shutdown Temperature

This field enables or disables the Shutdown Temperature

Disabled (default)

- 70 °C/158 F
- 75 °C/167 F
- 80 °C/176 F
- 85 °C/185 F
- 90 °C/194 F
- 90 °C/203 F

Temperatures/Voltages

These fields are the parameters of the hardware monitoring function feature of the motherboard. The values are read-only values as monitored by the system and show the PC health status

CPU Configuration

This section shows the CPU configuration parameters.

Aptio Setup Utility - Copyright © 2013 American Megatrends, Inc.

Main	Advanced	Chipset	Boot	Security	Save & Exit
CPU Configuration					
▶ Socket 0 CPU Information					
CPU Speed			1751 Mhz		
64-bit			Supported		
					→ ← Select Screen ↑ ↓ Select Item Enter: Select +- Change Opt. F1: General Help F2: Previous Values F3: Optimized Defaults F4: Save & Exit ESC: Exit

Socket 0 CPU Information

Socket specific CPU Information.

CPU PPM Configuration

Aptio Setup Utility - Copyright © 2013 American Megatrends, Inc.

Main	Advanced	Chipset	Boot	Security	Save & Exit
CPU PPM Configuration					
EIST			Enabled		→ ← Select Screen ↑ ↓ Select Item Enter: Select +- Change Field F1: General Help F2: Previous Values F3: Optimized Default F4: Save ESC: Exit

EIST

Enable/Disable Intel SpeedStep.

IDE Configuration

SATA Devices Configuration.

Aptio Setup Utility - Copyright © 2013 American Megatrends, Inc.

Main	Advanced	Chipset	Boot	Security	Save & Exit
IDE Configuration					
Serial-ATA (SATA)		Enabled			
SATA Mode		AHCI			
Serial-ATA Port 0		Enabled			
SATA Port0 HotPlug		Disabled		→ ← Select Screen	
Serial-ATA Port 1		Enabled		↑ ↓ Select Item	
SATA Port1 HotPlug		Disabled		Enter: Select	
SATA Port0		Not Present		+- Change Field	
SATA Port1		Not Present		F1: General Help	
				F2: Previous Values	
				F3: Optimized Default	
				F4: Save	
				ESC: Exit	

Serial-ATA(SATA)

Enabled / Disabled Serial ATA

SATA Mode

Select IDE / AHCI Mode

Serial -ATA Port 0

Enabled / Disabled Serial Port 0

SATA Port0 HotPlug

Enabled / Disabled SATA Port 0 HotPlug

Serial -ATA Port 1

Enabled / Disabled Serial Port 1

SATA Port1 HotPlug

Enabled / Disabled SATA Port 1 HotPlug

SDIO Configuration

Aptio Setup Utility - Copyright © 2013 American Megatrends, Inc.

Main	Advanced	Chipset	Boot	Security	Save & Exit
	SDIO Access Mode		Auto		→ ← Select Screen ↑ ↓ Select Item Enter: Select +- Change Field F1: General Help F2: Previous Values F3: Optimized Default F4: Save ESC: Exit

SDIO Access Mode

Auto Option: Access SD device in DMA mode if controller supports it. Otherwise, in PIO mode. DMA options: Access SD device in DMA mode. PIO Option: Access PIO device in DMA

Chipset Settings

Aptio Setup Utility - Copyright © 2013 American Megatrends, Inc.

Main	Advanced	Chipset	Boot	Security	Save & Exit
		▶ North Bridge			→ ← Select Screen ↑ ↓ Select Item Enter: Select +- Change Opt. F1: General Help F2: Previous Values F3: Optimized Defaults F4: Save & Exit ESC: Exit

North Bridge

Aptio Setup Utility - Copyright © 2013 American Megatrends, Inc.

Main	Advanced	Chipset	Boot	Security	Save & Exit
		Memory Information			→ ← Select Screen ↑ ↓ Select Item Enter: Select +- Change Opt. F1: General Help F2: Previous Values F3: Optimized Defaults F4: Save & Exit ESC: Exit
		Total Memory	4096 MB (LPDDR3)		
		Memory Slot0	4096 MB (LPDDR3)		
		Memory Slot2	Not Present		

Boot Settings

This section allows you to configure the boot settings.

Aptio Setup Utility - Copyright © 2013 American Megatrends, Inc.

Main	Advanced	Chipset	Boot	Security	Save & Exit
Boot Configuration					
Setup Prompt Timeout			1		
Bootup NumLock State			On		→ ← Select Screen
Quiet Boot			Disabled		↑ ↓ Select Item
Fast Boot			Disabled		Enter: Select
					+ - Change Opt.
					F1: General Help
Boot Option Priorities					F2: Previous Values
Boot Option #1			UEFI:Built-in EFI		F3: Optimized Defaults
					F4: Save & Exit
					ESC: Exit

Setup Prompt Timeout

Number of seconds to wait for setup activation key.
65535(0xFFFF) means indefinite waiting.

Bootup NumLock State

Select the keyboard NumLock state.

Quiet Boot

Enables or disables Quiet Boot option.

Fast Boot

Enables or disables boot with initialization of a minimal set of devices required to launch active boot option. Has no effect for BBS boot options.

Boot Option Priorities

Sets the system boot order.

Save & Exit Settings

Aptio Setup Utility – Copyright © 2013 American Megatrends, Inc.

Main	Advanced	Chipset	Boot	Security	Save & Exit
Save Changes and Exit Discard Changes and Exit Save Changes and Reset Discard Changes and Reset Save Options Save Changes Discard Changes Restore Defaults Save as User Defaults Restore User Defaults Boot Override					→ ← Select Screen ↑ ↓ Select Item Enter: Select +- Change Opt. F1: General Help F2: Previous Values F3: Optimized Defaults F4: Save & Exit ESC: Exit

Save Changes and Exit

Exit system setup after saving the changes.

Discard Changes and Exit

Exit system setup without saving any changes.

Save Changes and Reset

Reset the system after saving the changes.

Discard Changes and Reset

Reset system setup without saving any changes.

Save Changes

Save Changes done so far to any of the setup options.

Discard Changes

Discard Changes done so far to any of the setup options.

Restore Defaults

Restore/Load Defaults values for all the setup options.

Save as User Defaults

Save the changes done so far as User Defaults.

Restore User Defaults

Restore the User Defaults to all the setup options.

This page is intentionally left blank.

Drivers Installation

This section describes the installation procedures for software and drivers. The software and drivers are included with the motherboard. If you find the items missing, please contact the vendor where you made the purchase. The contents of this section include the following:

Intel Chipset Software Installation Utility	44
VGA Drivers Installation.....	45
Realtek High Definition Audio Driver Installation	46
Intel Trusted Execution Engine Installation.....	47

IMPORTANT NOTE:

After installing your Windows operating system, you must install first the Intel Chipset Software Installation Utility before proceeding with the drivers installation.

Intel Chipset Software Installation Utility

The Intel Chipset Drivers should be installed first before the software drivers to enable Plug & Play INF support for Intel chipset components. Follow the instructions below to complete the installation.

1. Insert the DVD that comes with the board. Click *Intel* and then *Intel(R) Baytrail Chipset*. Click *Intel(R) Chipset Software Installation Utility*.



3. When the Welcome screen to the Intel® Chipset Device Software appears, click *Next* to continue.

4. Click *Yes* to accept the software license agreement and proceed with the installation process.

5. The Setup process is now complete. Click *Finish* to restart the computer and for changes to take effect.

VGA Drivers Installation

1. Insert the DVD that comes with the board. Click *Intel* and then *Intel(R) Baytrail Chipset*. Click *Intel(R) Baytrail Graphics Driver*.



2. When the Welcome screen appears, click *Next* to continue.
3. Click *Yes* to accept the license agreement and continue the installation.
4. Setup complete. Click *Finish* to restart the computer and for changes to take effect.

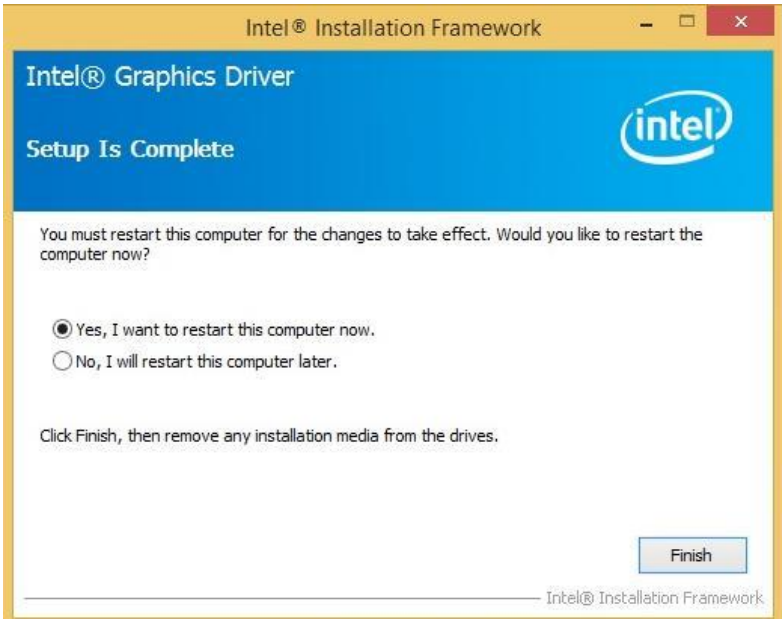

Realtek High Definition Audio Driver Installation

1. Insert the DVD that comes with the board. Click *Intel* and then *Intel(R) Baytrail Chipset*. Click *Realtek High Definition Audio Driver*.



2. On the Welcome screen, click *Next* to proceed with the installation.

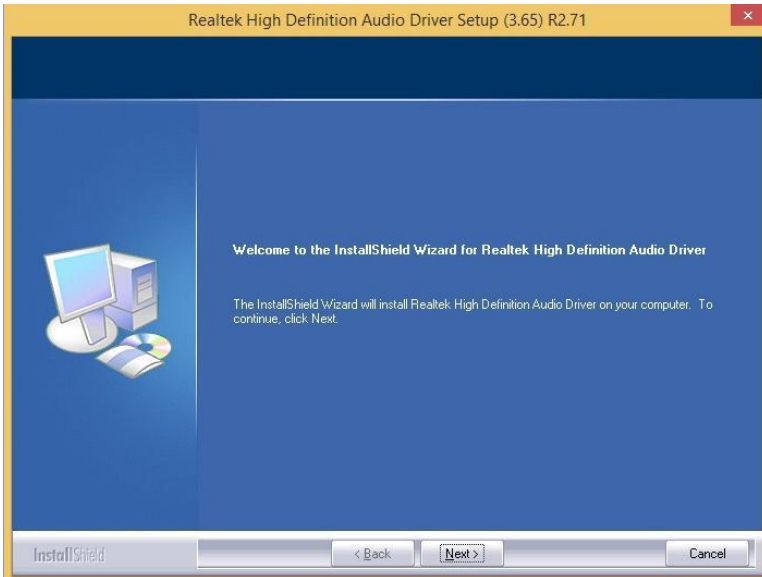

3. InstallShield Wizard is complete. Click *Finish* to restart the computer and for changes to take effect.

Intel Trusted Execution Engine Installation

Note :Windows 7 OS only

Important Notes

- 4) Intel TXE PV Firmware is signed by Intel
- PV POR configuration is signed Intel TXE FW and Production Silicon
 - Signed Intel TXE FW and Pre Production Silicon is supported for development needs only

Combination of unsigned Intel TXE Firmware and Production Silicon is not supported and will result in unexpected behavior

- 5) For Windows 7 OS only:
 Intel® Trusted Execution Engine Interface (Intel® TXEI) Driver uses KMDF (WDF) 1.11, which is built-in on Windows 8 and Windows 8.1. However, Windows 7 doesn't have it. Please install Kernel-Mode Driver Framework (KMDF) version 1.1. Otherwise, yellow bang appears on Intel TXEI device upon installation. Please follow instructions in this [link: KB2685811](#)

Other names and brands may be claimed as the property of others.
 All products, computer systems, dates and figures specifications are preliminary based on current expectations, and are subject to change without notice.

Intel Confidential



6

1. Insert the DVD that comes with the board. Click *Intel* and then *Intel(R) Baytrail Chipset*. Click *Intel(R) Baytrail Graphics Driver*.



2. On the Setup Welcome screen, click *Next* to proceed with the installation process.

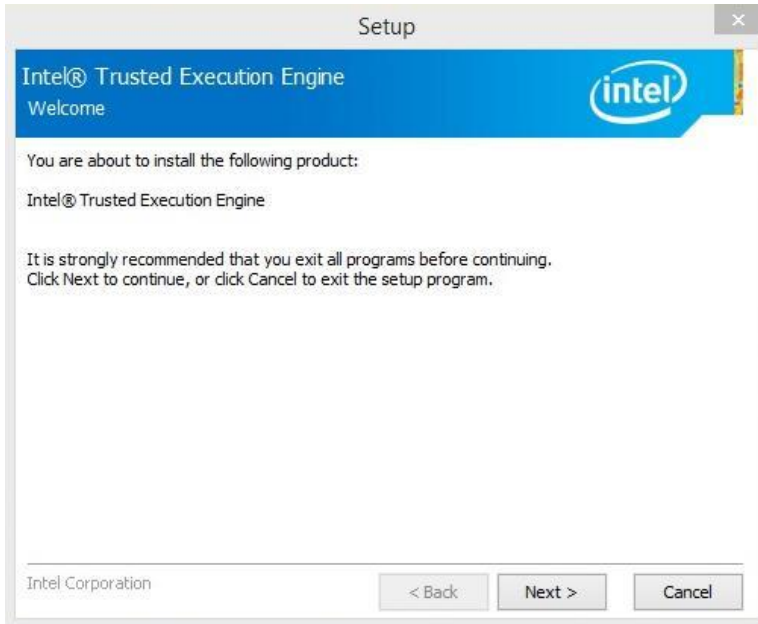

3. Click *Next* accept the license agreement and continue the installation.

4. Installation of the Intel Trusted Execution Engine is now complete. Click *Finish*.

Appendix

A. I/O Port Address Map

Each peripheral device in the system is assigned a set of I/O port addresses which also becomes the identity of the device. The following table lists the I/O port addresses used.

Address	Device Description
0000h-001Fh	Direct memory access controller
0000h-001Fh	PCI bus
0040h-0043h	System timer
0050h-0053h	System timer
0070h-0077h	System CMOS/real time clock
0081h-0091h	Direct memory access controller
0093h-009Fh	Direct memory access controller
00C0h-00DFh	Direct memory access controller
00F0h-00F0h	Numeric data processor
02F8h-02FFh	Communications Port (COM2)
03B0h-03BBh	Intel(R) HD Graphics 4600
03C0h-03DFh	Intel(R) HD Graphics 4600
03F8h-03FFh	Communications Port (COM1)
0D00h-FFFFh	PCI bus
E000h-EFFFh	Intel(R) 8 Series/C220 Series PCI Express Root Port #7 - 8C1C
F000h-F03Fh	Intel(R) HD Graphics 4600
F040h-F05Fh	Intel(R) 8 Series/C220 Series SMBus Controller - 8C22
F060h-F07Fh	Intel(R) 8 Series/C220 Series SATA AHCI Controller - 8C02
F0A0h-F0A3h	Intel(R) 8 Series/C220 Series SATA AHCI Controller - 8C02
F0B0h-F0B7h	Intel(R) 8 Series/C220 Series SATA AHCI Controller - 8C02
F0C0h-F0C3h	Intel(R) 8 Series/C220 Series SATA AHCI Controller - 8C02
F0D0h-F0D7h	Intel(R) 8 Series/C220 Series SATA AHCI Controller - 8C02
F0E0h-F0E7h	Intel(R) Active Management Technology - SOL (COM3)

B. Interrupt Request Lines (IRQ)

Peripheral devices use interrupt request lines to notify CPU for the service required. The following table shows the IRQ used by the devices on board.

Level	Function
IRQ0	System Timer
IRQ3	Serial Port #2
IRQ4	Serial Port #1
IRQ 10	Intel(R) 8 Series/C220 Series SMBus Controller - 8C22
IRQ 13	Numeric data processor
IRQ 16	High Definition Audio Controller
IRQ 16	Intel(R) 8 Series/C220 Series USB EHCI #2 - 8C2D
IRQ 16	Intel(R) Management Engine Interface
IRQ 19	Intel(R) 8 Series/C220 Series SATA AHCI Controller - 8C02
IRQ 19	Intel(R) Active Management Technology - SOL (COM3)
IRQ 22	High Definition Audio Controller
IRQ 23	Intel(R) 8 Series/C220 Series USB EHCI #1 - 8C26

C. Digital I/O Sample Code

File of the NCT5523D.H

```
//-----  
// THIS CODE AND INFORMATION IS PROVIDED "AS IS" WITHOUT WARRANTY OF ANY  
// KIND, EITHER EXPRESSED OR IMPLIED, INCLUDING BUT NOT LIMITED TO THE  
// IMPLIED WARRANTIES OF MERCHANTABILITY AND/OR FITNESS FOR A PARTICULAR  
// PURPOSE.  
//-----  
#ifndef __NCT5523D_H  
#define __NCT5523D_H          1  
//-----  
#define NCT5523D_INDEX_PORT    (NCT5523D_BASE)  
#define NCT5523D_DATA_PORT    (NCT5523D_BASE+1)  
//-----  
#define NCT5523D_REG_LD        0x07  
//-----  
#define NCT5523D_UNLOCK        0x87  
#define NCT5523D_LOCK          0xAA  
//-----  
unsigned int Init_NCT5523D(void);  
void Set_NCT5523D_LD( unsigned char);  
void Set_NCT5523D_Reg( unsigned char, unsigned char);  
unsigned char Get_NCT5523D_Reg( unsigned char);  
//-----  
#endif// __NCT5523D_H
```

APPENDIX

File of the MAIN.CPP

```
//-----  
// THIS CODE AND INFORMATION IS PROVIDED "AS IS" WITHOUT WARRANTY OF ANY  
// KIND, EITHER EXPRESSED OR IMPLIED, INCLUDING BUT NOT LIMITED TO THE  
// IMPLIED WARRANTIES OF MERCHANTABILITY AND/OR FITNESS FOR A PARTICULAR  
// PURPOSE.  
//-----  
#include <dos.h>  
#include <conio.h>  
#include <stdio.h>  
#include <stdlib.h>  
#include "NCT5523D.H"  
//-----  
int main (void);  
  
void Dio5Initial(void);  
void Dio5SetOutput(unsigned char);  
unsigned char Dio5GetInput(void);  
void Dio5SetDirection(unsigned char);  
unsigned char Dio5GetDirection(void);  
//-----  
int main (void)  
{  
    char SIO;  
  
    SIO = Init_NCT5523D();  
    if (SIO == 0)  
    {  
        printf("Can not detect Nuvoton NCT5523D, program abort.\n");  
        return(1);  
    }  
  
    Dio5Initial();  
  
    //for GPIO20..27  
    Dio5SetDirection(0x0F); //GP20..23 = input, GP24..27=output  
    printf("Current DIO direction = 0x%X\n", Dio5GetDirection());  
  
    printf("Current DIO status = 0x%X\n", Dio5GetInput());  
  
    printf("Set DIO output to high\n");  
    Dio5SetOutput(0x0F);  
  
    printf("Set DIO output to low\n");  
    Dio5SetOutput(0x00);  
  
    return 0;  
}  
//-----
```

```
void Dio5Initial(void)
{
    unsigned char ucBuf;

    ucBuf = Get_NCT5523D_Reg(0x1C);
    ucBuf &= ~0x02;
    Set_NCT5523D_Reg(0x1C, ucBuf);

    Set_NCT5523D_LD(0x07); //switch to logic device 7
    //enable the GP2 group
    ucBuf = Get_NCT5523D_Reg(0x30);
    ucBuf |= 0x04;
    Set_NCT5523D_Reg(0x30, ucBuf);
}
//-----
void Dio5SetOutput(unsigned char NewData)
{
    Set_NCT5523D_LD(0x07); //switch to logic device 7
    Set_NCT5523D_Reg(0xE1, NewData);
}
//-----
unsigned char Dio5GetInput(void)
{
    unsigned char result;

    Set_NCT5523D_LD(0x07); //switch to logic device 7
    result = Get_NCT5523D_Reg(0xE1);
    return (result);
}
//-----
void Dio5SetDirection(unsigned char NewData)
{
    //NewData : 1 for input, 0 for output
    Set_NCT5523D_LD(0x07); //switch to logic device 7
    Set_NCT5523D_Reg(0xE8, NewData);
}
//-----
unsigned char Dio5GetDirection(void)
{
    unsigned char result;

    Set_NCT5523D_LD(0x07); //switch to logic device 7
    result = Get_NCT5523D_Reg(0xE8);
    return (result);
}
//-----
```

APPENDIX

File of the NCT5523D.CPP

```
//-----  
// THIS CODE AND INFORMATION IS PROVIDED "AS IS" WITHOUT WARRANTY OF ANY  
// KIND, EITHER EXPRESSED OR IMPLIED, INCLUDING BUT NOT LIMITED TO THE  
// IMPLIED WARRANTIES OF MERCHANTABILITY AND/OR FITNESS FOR A PARTICULAR  
// PURPOSE.  
//-----  
#include "NCT5523D.H"  
#include <dos.h>  
//-----  
unsigned int NCT5523D_BASE;  
void Unlock_NCT5523D (void);  
void Lock_NCT5523D (void);  
//-----  
unsigned int Init_NCT5523D(void)  
{  
    unsigned int result;  
    unsigned char ucDid;  
  
    NCT5523D_BASE = 0x4E;  
    result = NCT5523D_BASE;  
  
    ucDid = Get_NCT5523D_Reg(0x20);  
    if (ucDid == 0xC4) //NCT5523D??  
    { goto Init_Finish; }  
  
    NCT5523D_BASE = 0x2E;  
    result = NCT5523D_BASE;  
  
    ucDid = Get_NCT5523D_Reg(0x20);  
    if (ucDid == 0xC4) //NCT5523D??  
    { goto Init_Finish; }  
  
    NCT5523D_BASE = 0x00;  
    result = NCT5523D_BASE;  
  
Init_Finish:  
    return (result);  
}  
//-----  
void Unlock_NCT5523D (void)  
{  
    outportb(NCT5523D_INDEX_PORT, NCT5523D_UNLOCK);  
    outportb(NCT5523D_INDEX_PORT, NCT5523D_UNLOCK);  
}  
//-----  
void Lock_NCT5523D (void)  
{  
    outportb(NCT5523D_INDEX_PORT, NCT5523D_LOCK);  
}  
//-----
```

```
void Set_NCT5523D_LD( unsigned char LD)
{
    Unlock_NCT5523D();
    outputb(NCT5523D_INDEX_PORT, NCT5523D_REG_LD);
    outputb(NCT5523D_DATA_PORT, LD);
    Lock_NCT5523D();
}
//-----
void Set_NCT5523D_Reg( unsigned char REG, unsigned char DATA)
{
    Unlock_NCT5523D();
    outputb(NCT5523D_INDEX_PORT, REG);
    outputb(NCT5523D_DATA_PORT, DATA);
    Lock_NCT5523D();
}
//-----
unsigned char Get_NCT5523D_Reg(unsigned char REG)
{
    unsigned char Result;
    Unlock_NCT5523D();
    outputb(NCT5523D_INDEX_PORT, REG);
    Result = inportb(NCT5523D_DATA_PORT);
    Lock_NCT5523D();
    return Result;
}
//-----
```

D. Watchdog Timer Configuration

The WDT is used to generate a variety of output signals after a user programmable count. The WDT is suitable for use in the prevention of system lock-up, such as when software becomes trapped in a deadlock. Under these sorts of circumstances, the timer will count to zero and the selected outputs will be driven. Under normal circumstance, the user will restart the WDT at regular intervals before the timer counts to zero.

SAMPLE CODE:

```
File of the NCT5523D.H
//-----
//
// THIS CODE AND INFORMATION IS PROVIDED "AS IS" WITHOUT WARRANTY OF ANY
// KIND, EITHER EXPRESSED OR IMPLIED, INCLUDING BUT NOT LIMITED TO THE
// IMPLIED WARRANTIES OF MERCHANTABILITY AND/OR FITNESS FOR A PARTICULAR
// PURPOSE.
//
//-----
#ifndef __NCT5523D_H
#define __NCT5523D_H          1
//-----
#define NCT5523D_INDEX_PORT (NCT5523D_BASE)
#define NCT5523D_DATA_PORT (NCT5523D_BASE+1)
//-----
#define NCT5523D_REG_LD      0x07
//-----
#define NCT5523D_UNLOCK      0x87
#define NCT5523D_LOCK        0xAA
//-----
unsigned int Init_NCT5523D(void);
void Set_NCT5523D_LD( unsigned char);
void Set_NCT5523D_Reg( unsigned char, unsigned char);
unsigned char Get_NCT5523D_Reg( unsigned char);
//-----
#endif// __NCT5523D_H
```

File of the MAIN.CPP.

```
//-----  
//  
// THIS CODE AND INFORMATION IS PROVIDED "AS IS" WITHOUT WARRANTY OF ANY  
// KIND, EITHER EXPRESSED OR IMPLIED, INCLUDING BUT NOT LIMITED TO THE  
// IMPLIED WARRANTIES OF MERCHANTABILITY AND/OR FITNESS FOR A PARTICULAR  
// PURPOSE.  
//  
//-----  
#include <dos.h>  
#include <conio.h>  
#include <stdio.h>  
#include <stdlib.h>  
#include "NCT5523D.H"  
//-----  
int main (void);  
  
void WDTInitial(void);  
void WDTEnable(unsigned char);  
void WDTDisable(void);  
  
//-----  
int main (void)  
{  
    char SIO;  
  
    SIO = Init_NCT5523D();  
    if (SIO == 0)  
    {  
        printf("Can not detect Nuvoton NCT5523D, program abort.\n");  
        return(1);  
    }  
  
    WDTInitial();  
  
    WDTEnable(10);  
  
    WDTDisable();  
  
    return 0;  
}  
//-----  
void WDTInitial(void)  
{  
    unsigned char bBuf;  
    Set_NCT5523D_LD(0x08); //switch to logic device 8  
    bBuf = Get_NCT5523D_Reg(0x30);  
    bBuf &= (~0x01);  
    Set_NCT5523D_Reg(0x30, bBuf); //Enable WDTO  
}  
//-----
```

APPENDIX

```
void WDTEnable(unsigned char NewInterval)
{
    unsigned char bBuf;

    Set_NCT5523D_LD(0x08);                //switch to logic device 8
    Set_NCT5523D_Reg(0x30, 0x01);        //enable timer

    bBuf = Get_NCT5523D_Reg(0xF0);
    bBuf &= (~0x08);
    Set_NCT5523D_Reg(0xF0, bBuf);        //count mode is second

    Set_NCT5523D_Reg(0xF1, NewInterval); //set timer
}
//-----
void WDTDisable(void)
{
    Set_NCT5523D_LD(0x08);                //switch to logic device 8
    Set_NCT5523D_Reg(0xF1, 0x00);        //clear watchdog timer
    Set_NCT5523D_Reg(0x30, 0x00);        //watchdog disabled
}
//-----
```

File of the NCT5523D.CPP

```
//-----
//
// THIS CODE AND INFORMATION IS PROVIDED "AS IS" WITHOUT WARRANTY OF ANY
// KIND, EITHER EXPRESSED OR IMPLIED, INCLUDING BUT NOT LIMITED TO THE
// IMPLIED WARRANTIES OF MERCHANTABILITY AND/OR FITNESS FOR A PARTICULAR
// PURPOSE.
//
//-----
#include "NCT5523D.H"
#include <dos.h>
//-----
unsigned int NCT5523D_BASE;
void Unlock_NCT5523D (void);
void Lock_NCT5523D (void);
//-----
unsigned int Init_NCT5523D(void)
{
    unsigned int result;
    unsigned char ucDid;

    NCT5523D_BASE = 0x4E;
    result = NCT5523D_BASE;

    ucDid = Get_NCT5523D_Reg(0x20);
    if (ucDid == 0xC4) //NCT5523D??
    { goto Init_Finish; }

    NCT5523D_BASE = 0x2E;
    result = NCT5523D_BASE;

    ucDid = Get_NCT5523D_Reg(0x20);
    if (ucDid == 0xC4) //NCT5523D??
    { goto Init_Finish; }

    NCT5523D_BASE = 0x00;
    result = NCT5523D_BASE;

Init_Finish:
    return (result);
}
//-----
void Unlock_NCT5523D (void)
{
    outportb(NCT5523D_INDEX_PORT, NCT5523D_UNLOCK);
    outportb(NCT5523D_INDEX_PORT, NCT5523D_UNLOCK);
}
//-----
void Lock_NCT5523D (void)
{
    outportb(NCT5523D_INDEX_PORT, NCT5523D_LOCK);
}
//-----
```

```
void Set_NCT5523D_LD( unsigned char LD)
{
    Unlock_NCT5523D();
    outportb(NCT5523D_INDEX_PORT, NCT5523D_REG_LD);
    outportb(NCT5523D_DATA_PORT, LD);
    Lock_NCT5523D();
}
//-----
void Set_NCT5523D_Reg( unsigned char REG, unsigned char DATA)
{
    Unlock_NCT5523D();
    outportb(NCT5523D_INDEX_PORT, REG);
    outportb(NCT5523D_DATA_PORT, DATA);
    Lock_NCT5523D();
}
//-----
unsigned char Get_NCT5523D_Reg(unsigned char REG)
{
    unsigned char Result;
    Unlock_NCT5523D();
    outportb(NCT5523D_INDEX_PORT, REG);
    Result = inportb(NCT5523D_DATA_PORT);
    Lock_NCT5523D();
    return Result;
}
//-----
```

