

ET880 Series

**COM Express (Type 6 & R3.0) Module
with Intel® Atom® x6000 Series SoC**

User's Manual

Version 1.0
(April 2023)

Copyright

© 2023 IBASE Technology, Inc. All rights reserved.

No part of this publication may be reproduced, copied, stored in a retrieval system, translated into any language or transmitted in any form or by any means, electronic, mechanical, photocopying, or otherwise, without the prior written consent of IBASE Technology, Inc. (hereinafter referred to as “IBASE”).

Disclaimer

IBASE reserves the right to make changes and improvements to the products described in this document without prior notice. Every effort has been made to ensure the information in the document is correct; however, IBASE does not guarantee this document is error-free.

IBASE assumes no liability for incidental or consequential damages arising from misapplication or inability to use the product or the information contained herein, nor for any infringements of rights of third parties, which may result from its use.

Trademarks

All the trademarks, registrations and brands mentioned herein are used for identification purposes only and may be trademarks and/or registered trademarks of their respective owners.

Compliance



This product has passed CE tests for environmental specifications and limits. This product is in accordance with the directives of the European Union (EU). In a domestic environment, this product may cause radio interference in which case users may be required to take adequate measures.



This product has been tested and found to comply with the limits for a Class B device, pursuant to Part 15 of the FCC Rules. These limits are designed to provide reasonable protection against harmful interference in a residential installation. This equipment generates, uses and can radiate radio frequency energy and, if not installed and used in accordance with manufacturer's instructions, may cause harmful interference to radio communications.

WEEE



This product must not be disposed of as normal household waste, in accordance with the EU directive of for waste electrical and electronic equipment (WEEE - 2012/19/EU). Instead, it should be disposed of by returning it to a municipal recycling collection point. Check local regulations for disposal of electronic products.

Green IBASE



This product is compliant with the current RoHS restrictions and prohibits use of the following substances in concentrations exceeding 0.1% by weight (1000 ppm) except for cadmium, limited to 0.01% by weight (100 ppm).

- Lead (Pb)
- Mercury (Hg)
- Cadmium (Cd)
- Hexavalent chromium (Cr6+)
- Polybrominated biphenyls (PBB)
- Polybrominated diphenyl ether (PBDE)

Important Safety Information

Carefully read the precautions before using the board.

Environmental conditions:

- Use this product in environments with ambient temperatures between -40°C and 85°C.
- Do not leave this product in an environment where the storage temperature may be below 40° C or above 90° C. To prevent from damages, the product must be used in a controlled environment.

Care for your iBASE products:

- Before cleaning the PCB, unplug all cables and remove the battery.
- Clean the PCB with a circuit board cleaner, degreaser or use cotton swabs and alcohol.
- Vacuum the dust with a computer vacuum cleaner to prevent the fan from being clogged.



WARNING

Attention during use:

- Do not use this product near water.
- Do not spill water or any other liquids on this product.
- Do not place heavy objects on the top of this product.

Anti-static precautions

- Wear an anti-static wrist strap to avoid electrostatic discharge.
- Place the PCB on an anti-static kit or mat.
- Hold the edges of PCB when handling.
- Touch the edges of non-metallic components of the product instead of the surface of the PCB.
- Ground yourself by touching a grounded conductor or a grounded bit of metal frequently to discharge any static.



CAUTION

Danger of explosion if the internal lithium-ion battery is replaced by an incorrect type. Replace only with the same or equivalent type recommended by the manufacturer. Dispose of used batteries according to the manufacturer's instructions or recycle them at a local recycling facility or battery collection point.

Warranty Policy

- **IBASE standard products:**

24-month (2-year) warranty from the date of shipment. If the date of shipment cannot be ascertained, the product serial numbers can be used to determine the approximate shipping date.

- **3rd-party parts:**

12-month (1-year) warranty from delivery for the 3rd-party parts that are not manufactured by IBASE, such as CPU, CPU cooler, memory, storage devices, power adapter, panel and touchscreen.

- * PRODUCTS, HOWEVER, THAT FAIL DUE TO MISUSE, ACCIDENT, IMPROPER INSTALLATION OR UNAUTHORIZED REPAIR SHALL BE TREATED AS OUT OF WARRANTY AND CUSTOMERS SHALL BE BILLED FOR REPAIR AND SHIPPING CHARGES.

Technical Support & Services

1. Visit the IBASE website at www.ibase.com.tw to find the latest information about the product.
2. If you need any further assistance from your distributor or sales representative, prepare the following information of your product and elaborate upon the problem.
 - Product model name
 - Product serial number
 - Detailed description of the problem
 - The error messages in text or in screenshots if there is any
 - The arrangement of the peripherals
 - Software in use (such as OS and application software, including the version numbers)
3. If repair service is required, please log in to the RMA system of the website or and contact your distributor or sales representative for assistance.

Table of Contents

Chapter 1	General Information	1
1.1	Introduction	2
1.2	Features	2
1.3	Packing List	3
1.4	Optional Accessories	3
1.5	Specifications	3
1.6	Block Diagram	5
1.7	Product View	6
1.8	Dimensions	7
Chapter 2	Hardware Configuration	9
2.1	Installations	10
2.1.1	Installing the Memory	10
2.2	Switch, Jumper and Connector Location	11
2.3	Switch and Connector Quick Reference	12
2.3.1	AT / ATX Mode Switch (SW1)	12
2.3.2	COM Express Module Type 6 Connector (SOM1, SOM2) ...	13
Chapter 3	Drivers Installation	17
3.1	Introduction	18
3.2	Intel® Chipset Software Installation Utility	18
3.3	Graphics Driver Installation	20
3.4	HD Audio Driver Installation	22
3.5	Intel® ME Drivers	24
3.6	LAN Driver Installation	26
Chapter 4	BIOS Setup	29
4.1	Introduction	30
4.2	BIOS Setup	30
4.3	Main Settings	31
4.4	Advanced Settings	31
4.5	Chipset Settings	43
4.6	Security Settings	45
4.7	Boot Settings	47
4.8	Save & Exit Settings	48

Appendix	49
A. I/O Port Address Map	50
B. Interrupt Request Lines (IRQ)	52
C. Watchdog Timer Configuration.....	53

This page is intentionally left blank.

Chapter 1

General Information

The information provided in this chapter includes:

- Features
- Packing List
- Optional Accessories
- Specifications
- Block Diagram
- Product View
- Board Dimensions

1.1 Introduction

ET880 is a COM Express module based on the Intel® Atom™x7/x5 processor. It comes with type 6 pinouts and complies with the PICMG COM.0 Rev.3.0 specifications. ET880 features 8GB DDR4 memory on board, a DDR4 SODIMM socket, and outputs signals for DVI, DisplayPort and eDP/LVDS interface connection.



ET880

1.2 Features

- Onboard Intel® Atom® x6000 series processors
- Onboard 8GB DDR4 memory + 1x DDR4 SO-DIMM, IBECC compatible
- 1x I226IT PCI-E 2.5G LAN
- 2x USB 3.1, 4x USB 2.0, 2x SATA III, 2x UART (Tx/Rx only)
- Supports 3x independent displays, DisplayPort /DVI-D / LVDS or eDP via carrier board (IP419)
- Supports wide-range operating temperature

1.3 Packing List

Your product package should include the items listed below. If any of the items below is missing, contact the distributor or dealer from whom you purchased the product.

- ET880 COM Express Module

1.4 Optional Accessories

- Heatsink for ET880 with Atom® x6000 series SoC - HSET880-A
- Heat spreader for ET880 with Atom® x6000 series SoC - HSET880-1

1.5 Specifications

Models	
ET880-6425E	COM Express (Type-6) module w/ Intel® Atom® x6425E SoC on board, supports eDP
ET880-6425ELV	COM Express (Type-6) module w/ Intel® Atom® x6425E SoC on board, supports LVDS
ET880-6211E	COM Express (Type-6) module w/ Intel® Atom® x6211E SoC on board, supports eDP
ET880-6211ELV	COM Express (Type-6) module w/ Intel® Atom® x6211E SoC on board, supports LVDS
Specifications	
CPU	<ul style="list-style-type: none"> • Intel® Atom® QC x6425E (1.8Ghz/3.0GHz) • Intel® Atom® DC x6211E (1.2Ghz/3.0GHz)
PCH	Integrated in Intel® SoC
Memory Type	<ul style="list-style-type: none"> • Onboard DDR4 8GB & 1x DDR4 SO-DIMM • Max. 24GB, IB ECC compatible
BIOS	AMI
Watchdog Timer	256 levels

Specifications	
Hardware Monitor	Yes
Storage Interface	N/A
Expansion Slots	5x PCI-E(x1) to carrier board
Graphics Controller	Intel® Gen11 integrated graphics
Video Output	2x DDI, LVDS or eDP on carrier board
Ethernet	<ul style="list-style-type: none">• 1x Intel I226IT 2.5GbE• RJ45 on carrier board
I/O Chipset	Fintek F81804U-I
Serial Port	2x COM ports (Tx/Rx only)
USB 2.0	4x USB2.0 via carrier board
USB 3.X	2x USB3.1 (5Gbps) via carrier board
Serial ATA	2x SATA III via carrier board
Audio	Built-in HD Audio controller
TPM	TPM (2.0)
Others	Digital I/O (4-in/4-out)
Dimensions (L X W)	95mm x 95mm (3.74" x 3.74")
Operating Temperature	-40°C~+85°C (-40°F~+185°F); excluding SO-DIMM memory module
Storage Temperature	-40°C~90°C (-40°F~+194°F)
Relative Humidity	90% (non-condensing @60°C)

All specifications are subject to change without prior notice.

1.6 Block Diagram

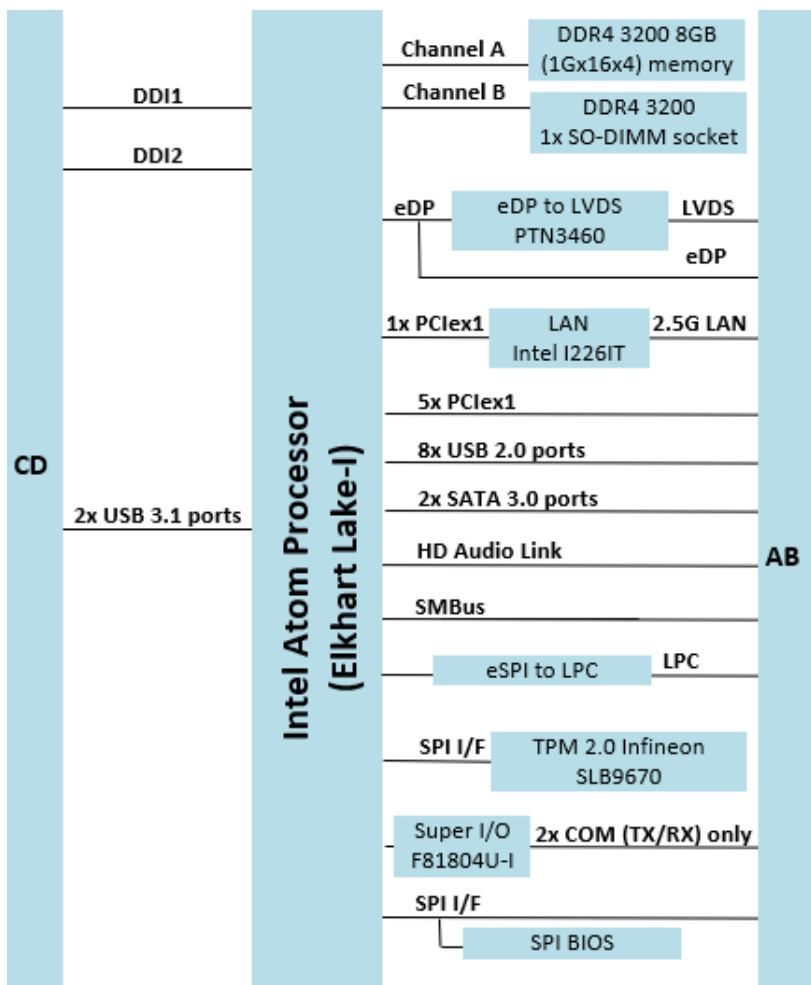

1.7 Product View

Top View



Bottom View

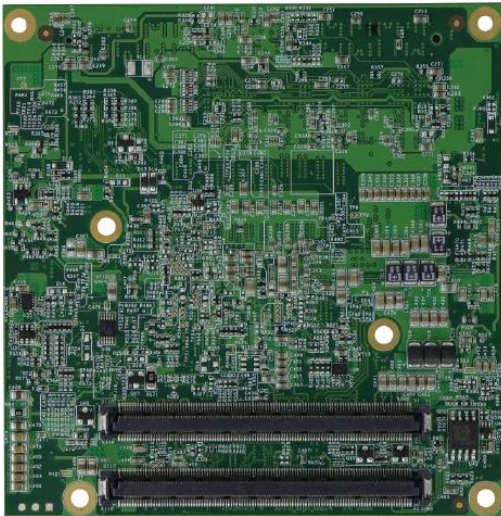

* The photos above are for reference only. Some minor components may differ.

1.8 Dimensions

Unit: mm

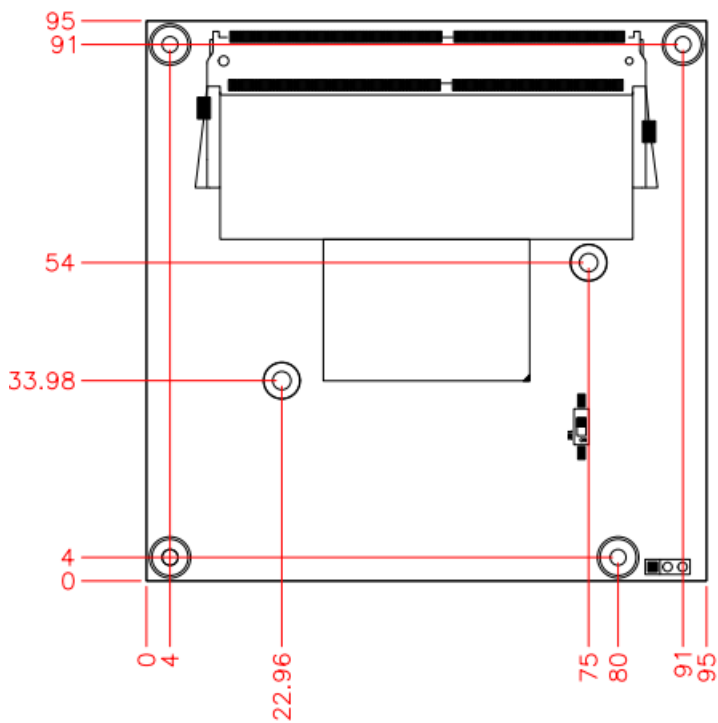

This page is intentionally left blank.

Chapter 2

Hardware Configuration

This section provides information on jumper settings and connectors on the ET880 in order to set up a workable system. On top of that, you will also need to install crucial pieces such as the CPU and the memory before using the product. The topics covered are:

- Installations
- Jumper and connector locations
- Jumper settings and information of connectors

2.1 Installations

2.1.1 Installing the Memory

If you need to replace or install a memory module, locate the memory slot on the board and perform the following steps:

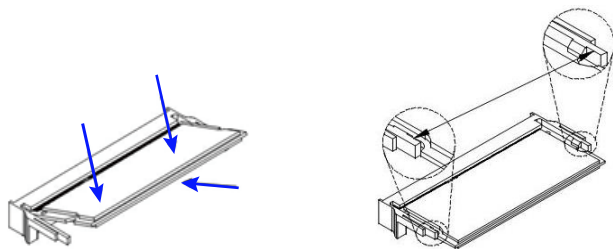

1. Align the key of the memory module with that on the memory slot and insert the module slantwise.
2. Gently push the module in an upright position until the clips of the slot close to hold the module in place when the module touches the bottom of the slot.

To remove the module, press the clips outwards with both hands, and the module will pop-up.

2.2 Switch, Jumper and Connector Location

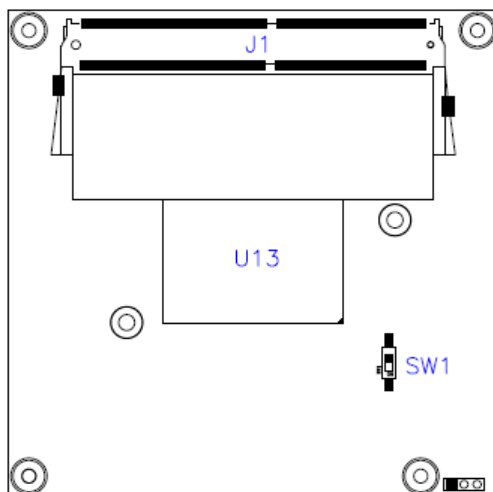

J14

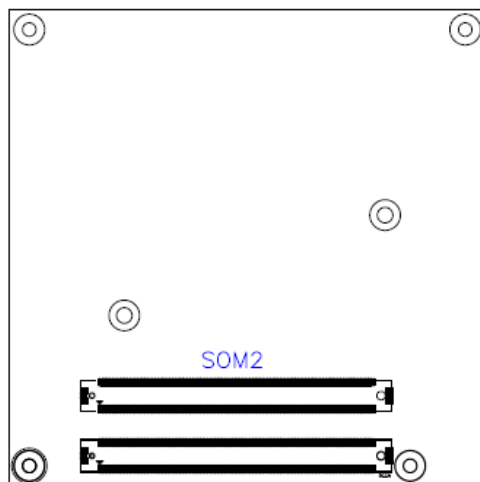

SOM1

2.3 Switch and Connector Quick Reference

Function	Jumper
AT / ATX Mode Switch	SW1
Connector to Carrier Board	SOM1, SOM2
DDR4 SO-DIMM Slot	J1

2.3.1 AT / ATX Mode Switch (SW1)

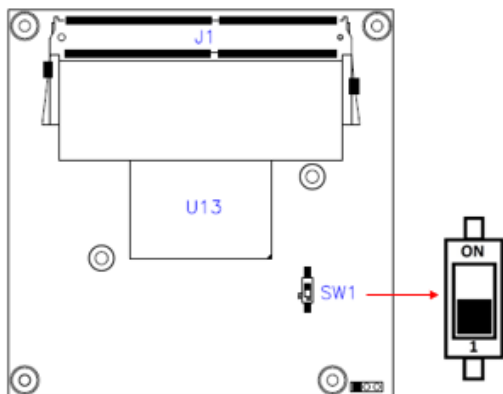

Function	Pin closed	Illustration
ATX Mode (default)	OFF (Pin 1)	
AT Mode	ON (Pin 2)	

2.3.2 COM Express Module Type 6 Connector (SOM1, SOM2)

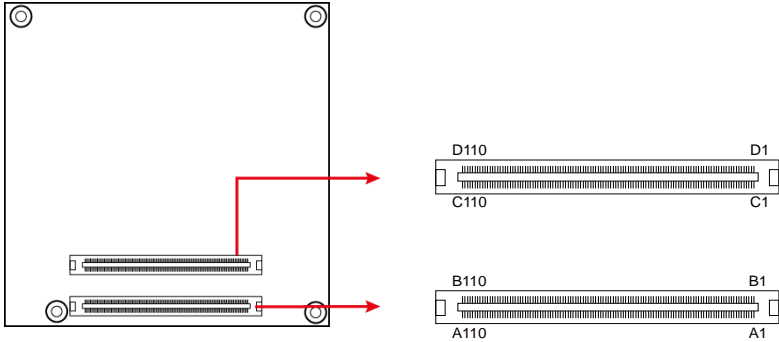

Row A		Row B		Row C		Row D	
Pin	Signal	Pin	Signal	Pin	Signal	Pin	Signal
A1	GND (FIXED)	B1	GND (FIXED)	C1	GND (FIXED)	D1	GND (FIXED)
A2	GBE0_MDI3-	B2	GBE0_ACT#	C2	GND	D2	GND
A3	GBE0_MDI3+	B3	LPC_FRAME#	C3	USB_SSRX0-	D3	USB_SSTX0-
A4	GBE0_LINK100#	B4	LPC_AD0	C4	USB_SSRX0+	D4	USB_SSTX0+
A5	GBE0_LINK1000#	B5	LPC_AD1	C5	GND	D5	GND
A6	GBE0_MDI2-	B6	LPC_AD2	C6	USB_SSRX1-	D6	USB_SSTX1-
A7	GBE0_MDI2+	B7	LPC_AD3	C7	USB_SSRX1+	D7	USB_SSTX1+
A8	GBE0_LINK#	B8	LPC_DRQ0#(NC)	C8	GND	D8	GND
A9	GBE0_MDI1-	B9	LPC_DRQ1#	C9	USB_SSRX2-(NC)	D9	USB_SSTX2-(NC)
A10	GBE0_MDI1+	B10	LPC_CLK	C10	USB_SSRX2+(NC)	D10	USB_SSTX2+(NC)
A11	GND (FIXED)	B11	GND (FIXED)	C11	GND (FIXED)	D11	GND (FIXED)
A12	GBE0_MDI0-	B12	PWRBTN#	C12	USB_SSRX3-(NC)	D12	USB_SSTX3-(NC)
A13	GBE0_MDI0+	B13	SMB_CK	C13	USB_SSRX3+(NC)	D13	USB_SSTX3+(NC)
A14	GBE0_CTREF	B14	SMB_DAT	C14	GND	D14	GND
A15	SUS_S3#	B15	SMB_ALERT#	C15	DDI1_PAIR6+(NC)	D15	DDI1_CTRLCLK_AUX+
A16	SATA0_TX+	B16	SATA1_TX+	C16	DDI1_PAIR6-(NC)	D16	DDI1_CTRLDATA_AUX-
A17	SATA0_TX-	B17	SATA1_TX-	C17	RSVD(NC)	D17	RSVD(NC)
A18	SUS_S4#	B18	SUS_STAT#	C18	RSVD(NC)	D18	RSVD(NC)
A19	SATA0_RX+	B19	SATA1_RX+	C19	PCIE_RX6+(NC)	D19	PCIE_TX6+(NC)
A20	SATA0_RX-	B20	SATA1_RX-	C20	PCIE_RX6-(NC)	D20	PCIE_TX6-(NC)
A21	GND (FIXED)	B21	GND (FIXED)	C21	GND (FIXED)	D21	GND (FIXED)
A22	SATA2_TX+(NC)	B22	SATA3_TX+(NC)	C22	PCIE_RX7+(NC)	D22	PCIE_TX7+(NC)
A23	SATA2_TX-(NC)	B23	SATA3_TX-(NC)	C23	PCIE_RX7-(NC)	D23	PCIE_TX7-(NC)
A24	SUS_S5#	B24	PWR_OK	C24	DDI1_HPD	D24	RSVD(NC)
A25	SATA2_RX+(NC)	B25	SATA3_RX+(NC)	C25	DDI1_PAIR4+(NC)	D25	RSVD(NC)
A26	SATA2_RX-(NC)	B26	SATA3_RX-(NC)	C26	DDI1_PAIR4-(NC)	D26	DDI1_PAIR0+
A27	BATLOW#	B27	WDT	C27	RSVD(NC)	D27	DDI1_PAIR0-
A28	SATA_ACT#	B28	HDA_SDIN2(NC)	C28	RSVD(NC)	D28	RSVD(NC)
A29	HDA_SYNC	B29	HDA_SDIN1(NC)	C29	DDI1_PAIR5+(NC)	D29	DDI1_PAIR1+
A30	HDA_RST#	B30	HDA_SDIN0	C30	DDI1_PAIR5-(NC)	D30	DDI1_PAIR1-

Row A		Row B		Row C		Row D	
Pin	Signal	Pin	Signal	Pin	Signal	Pin	Signal
A31	GND (FIXED)	B31	GND (FIXED)	C31	GND (FIXED)	D31	GND (FIXED)
A32	HDA_BITCLK	B32	SPKR	C32	DDI2_CTRLCLK_A UX+	D32	DDI1_PAIR2+
A33	HDA_SDOUT	B33	I2C_CK	C33	DDI2_CTRLDATA_ AUX-	D33	DDI1_PAIR2-
A34	BIOS_DIS0#	B34	I2C_DAT	C34	DDI2_DDC_AUX_S EL	D34	DDI1_DDC_AUX_ SEL
A35	THRMTRIP#	B35	THRM#	C35	RSVD(NC)	D35	RSVD(NC)
A36	USB6-	B36	USB7-	C36	DDI3_CTRLCLK_A UX+(NC)	D36	DDI1_PAIR3+
A37	USB6+	B37	USB7+	C37	DDI3_CTRLDATA_ AUX-(NC)	D37	DDI1_PAIR3-
A38	USB_6_7_OC#	B38	USB_4_5_OC#	C38	DDI3_DDC_AUX_S EL(NC)	D38	RSVD(NC)
A39	USB4-	B39	USB5-	C39	DDI3_PAIR0+(NC)	D39	DDI2_PAIR0+
A40	USB4+	B40	USB5+	C40	DDI3_PAIR0-(NC)	D40	DDI2_PAIR0-
A41	GND (FIXED)	B41	GND (FIXED)	C41	GND (FIXED)	D41	GND (FIXED)
A42	USB2-	B42	USB3-	C42	DDI3_PAIR1+(NC)	D42	DDI2_PAIR1+
A43	USB2+	B43	USB3+	C43	DDI3_PAIR1-(NC)	D43	DDI2_PAIR1-
A44	USB_2_3_OC#	B44	USB_0_1_OC#	C44	DDI3_HPD(NC)	D44	DDI2_HPD
A45	USB0-	B45	USB1-	C45	RSVD	D45	RSVD(NC)
A46	USB0+	B46	USB1+	C46	DDI3_PAIR2+(NC)	D46	DDI2_PAIR2+
A47	VCC_RTC	B47	ESPI_EN#(NC)	C47	DDI3_PAIR2-(NC)	D47	DDI2_PAIR2-
A48	RSVD(NC)	B48	USB0_HOST_PR SNT(NC)	C48	RSVD(NC)	D48	RSVD(NC)
A49	GBE0_SDP	B49	SYS_RESET#	C49	DDI3_PAIR3+(NC)	D49	DDI2_PAIR3+
A50	LPC_SERIRQ	B50	CB_RESET#	C50	DDI3_PAIR3-(NC)	D50	DDI2_PAIR3-
A51	GND (FIXED)	B51	GND (FIXED)	C51	GND (FIXED)	D51	GND (FIXED)
A52	PCIE_TX5+(NC)	B52	PCIE_RX5+(NC)	C52	PEG_RX0+(NC)	D52	PEG_TX0+(NC)
A53	PCIE_TX5-(NC)	B53	PCIE_RX5-(NC)	C53	PEG_RX0-(NC)	D53	PEG_TX0-(NC)
A54	GPIO	B54	GPO1(OUT1)	C54	TYPE0#(NC)	D54	PEG_LANE_RV#(NC)
A55	PCIE_TX4+	B55	PCIE_RX4+	C55	PEG_RX1+(NC)	D55	PEG_TX1+(NC)
A56	PCIE_TX4-	B56	PCIE_RX4-	C56	PEG_RX1-(NC)	D56	PEG_TX1-(NC)
A57	GND	B57	GPO2(OUT2)	C57	TYPE1#(NC)	D57	TYPE2#
A58	PCIE_TX3+	B58	PCIE_RX3+	C58	PEG_RX2+(NC)	D58	PEG_TX2+(NC)
A59	PCIE_TX3-	B59	PCIE_RX3-	C59	PEG_RX2-(NC)	D59	PEG_TX2-(NC)
A60	GND (FIXED)	B60	GND (FIXED)	C60	GND (FIXED)	D60	GND (FIXED)
A61	PCIE_TX2+	B61	PCIE_RX2+	C61	PEG_RX3+(NC)	D61	PEG_TX3+(NC)
A62	PCIE_TX2-	B62	PCIE_RX2-	C62	PEG_RX3-(NC)	D62	PEG_TX3-(NC)
A63	GPI1(IN1)	B63	GPO3(OUT3)	C63	RSVD(NC)	D63	RSVD(NC)
A64	PCIE_TX1+	B64	PCIE_RX1+	C64	RSVD(NC)	D64	RSVD(NC)
A65	PCIE_TX1-	B65	PCIE_RX1-	C65	PEG_RX4+(NC)	D65	PEG_TX4+(NC)
A66	GND	B66	WAKE0#	C66	PEG_RX4-(NC)	D66	PEG_TX4-(NC)
A67	GPI2(IN2)	B67	WAKE1#	C67	RAPID_SHUTDOWN(NC)	D67	GND
A68	PCIE_TX0+	B68	PCIE_RX0+	C68	PEG_RX5+(NC)	D68	PEG_TX5+(NC)
A69	PCIE_TX0-	B69	PCIE_RX0-	C69	PEG_RX5-(NC)	D69	PEG_TX5-(NC)
A70	GND (FIXED)	B70	GND (FIXED)	C70	GND (FIXED)	D70	GND (FIXED)
A71	LVDS_A0+	B71	LVDS_B0+	C71	PEG_RX6+(NC)	D71	PEG_TX6+(NC)
A72	LVDS_A0-	B72	LVDS_B0-	C72	PEG_RX6-(NC)	D72	PEG_TX6-(NC)
A73	LVDS_A1+	B73	LVDS_B1+	C73	GND	D73	GND
A74	LVDS_A1-	B74	LVDS_B1-	C74	PEG_RX7+(NC)	D74	PEG_TX7+(NC)
A75	LVDS_A2+	B75	LVDS_B2+	C75	PEG_RX7-(NC)	D75	PEG_TX7-(NC)

Row A		Row B		Row C		Row D	
Pin	Signal	Pin	Signal	Pin	Signal	Pin	Signal
A76	LVDS_A2-	B76	LVDS_B2-	C76	GND	D76	GND
A77	LVDS_VDD_EN	B77	LVDS_B3+	C77	RSVD(NC)	D77	RSVD(NC)
A78	LVDS_A3+	B78	LVDS_B3-	C78	PEG_RX8+(NC)	D78	PEG_TX8+(NC)
A79	LVDS_A3-	B79	LVDS_BKLT_EN	C79	PEG_RX8-(NC)	D79	PEG_TX8-(NC)
A80	GND (FIXED)	B80	GND (FIXED)	C80	GND (FIXED)	D80	GND (FIXED)
A81	LVDS_A_CK+	B81	LVDS_B_CK+	C81	PEG_RX9+(NC)	D81	PEG_TX9+(NC)
A82	LVDS_A_CK-	B82	LVDS_B_CK-	C82	PEG_RX9-(NC)	D82	PEG_TX9-(NC)
A83	LVDS_I2C_CK	B83	LVDS_BKLT_CTL	C83	RSVD(NC)	D83	RSVD(NC)
A84	LVDS_I2C_DAT	B84	VCC_5V_SBY	C84	GND	D84	GND
A85	GPI3(IN3)	B85	VCC_5V_SBY	C85	PEG_RX10+(NC)	D85	PEG_TX10+(NC)
A86	RSVD(NC)	B86	VCC_5V_SBY	C86	PEG_RX10-(NC)	D86	PEG_TX10-(NC)
A87	eDP_HPD	B87	VCC_5V_SBY	C87	GND	D87	GND
A88	PCIE_CLK_REF+	B88	BIOS_DIS1#	C88	PEG_RX11+(NC)	D88	PEG_TX11+(NC)
A89	PCIE_CLK_REF-	B89	VGA_RED(NC)	C89	PEG_RX11-(NC)	D89	PEG_TX11-(NC)
A90	GND (FIXED)	B90	GND (FIXED)	C90	GND (FIXED)	D90	GND (FIXED)
A91	SPI_POWER	B91	VGA_GRN(NC)	C91	PEG_RX12+(NC)	D91	PEG_TX12+(NC)
A92	SPI_MISO	B92	VGA_BLU(NC)	C92	PEG_RX12-(NC)	D92	PEG_TX12-(NC)
A93	GPO0(OUT0)	B93	VGA_HSYNC(NC)	C93	GND	D93	GND
A94	SPI_CLK	B94	VGA_VSYNC(NC)	C94	PEG_RX13+(NC)	D94	PEG_TX13+(NC)
A95	SPI_MOSI	B95	VGA_I2C_CK(NC)	C95	PEG_RX13-(NC)	D95	PEG_TX13-(NC)
A96	TPM_PP	B96	VGA_I2C_DAT(NC)	C96	GND	D96	GND
A97	TYPE10#(NC)	B97	SPI_CS#	C97	RSVD(NC)	D97	RSVD
A98	SER0_TX	B98	RSVD(NC)	C98	PEG_RX14+(NC)	D98	PEG_TX14+(NC)
A99	SER0_RX	B99	RSVD(NC)	C99	PEG_RX14-(NC)	D99	PEG_TX14-(NC)
A100	GND (FIXED)	B100	GND (FIXED)	C100	GND (FIXED)	D100	GND (FIXED)
A101	SER1_TX	B101	FAN_PWMOUT	C101	PEG_RX15+(NC)	D101	PEG_TX15+(NC)
A102	SER1_RX	B102	FAN_TACHIN	C102	PEG_RX15-(NC)	D102	PEG_TX15-(NC)
A103	LID#(NC)	B103	SLEEP#(NC)	C103	GND	D103	GND
A104	VCC_12V	B104	VCC_12V	C104	VCC_12V	D104	VCC_12V
A105	VCC_12V	B105	VCC_12V	C105	VCC_12V	D105	VCC_12V
A106	VCC_12V	B106	VCC_12V	C106	VCC_12V	D106	VCC_12V
A107	VCC_12V	B107	VCC_12V	C107	VCC_12V	D107	VCC_12V
A108	VCC_12V	B108	VCC_12V	C108	VCC_12V	D108	VCC_12V
A109	VCC_12V	B109	VCC_12V	C109	VCC_12V	D109	VCC_12V
A110	GND (FIXED)	B110	GND (FIXED)	C110	GND (FIXED)	D110	GND (FIXED)

This page is intentionally left blank.

Chapter 3

Drivers Installation

This chapter introduces installation of the following drivers:

- Intel® Chipset Software Installation Utility
- Graphics Driver
- HD Audio Driver
- Intel® ME Drivers
- LAN Driver

3.1 Introduction

This section describes the installation procedures for software and drivers. The contents of this section include the following:

Note: After installing your Windows operating system, you must install the Intel® Chipset Software Installation Utility first before proceeding with the drivers installation.

3.2 Intel® Chipset Software Installation Utility

The Intel® Chipset drivers should be installed first before the software drivers to install INF files for Plug & Play function for Intel chipset components. Follow the instructions below to complete the installation.

1. Go to the download page of the product. Copy the compressed drivers file to your computer. Double click the file to decompress it. Run “CDGuide” to go to the main drivers page as shown. Click **Intel** on the left pane and then **Intel(R) Elkhartlake Chipset Drivers** on the right pane.



- Click **Intel(R) Chipset Software Installation Utility**.



- When the *Welcome* screen to the Intel® Chipset Device Software appears, click **Next**.
- Accept the software license agreement and click **Yes**.
- On the *Readme File Information* screen, click **Install**.



- When the driver has been completely installed, restart the computer for changes to take effect.

3.3 Graphics Driver Installation

1. Click **Intel** on the left pane and then **Intel(R) Elkhartlake Chipset Drivers** on the right pane.



2. Click **Intel(R) Elkhartlake Graphics Driver**.



3. When the *intel Graphics Driver Installer* screen appears, click **Begin Installation**.



4. Accept the Intel Software License Agreement. Click **I agree**.
5. The installer shows the components to be installed. Click **Start**.

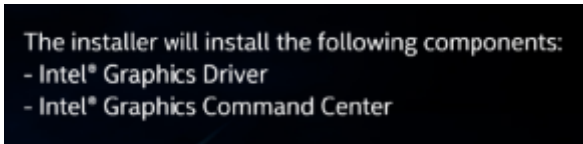

6. When the screen shows the message "Installation complete!", click **Finish**.

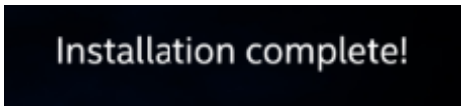

3.4 HD Audio Driver Installation

1. Click **Intel** on the left pane and then **Intel(R) Elkhartlake Chipset Drivers** on the right pane.



2. Click **Realtek High Definition Audio Driver**.



3. On the *Welcome* screen of the InstallShield Wizard, click **Next**.

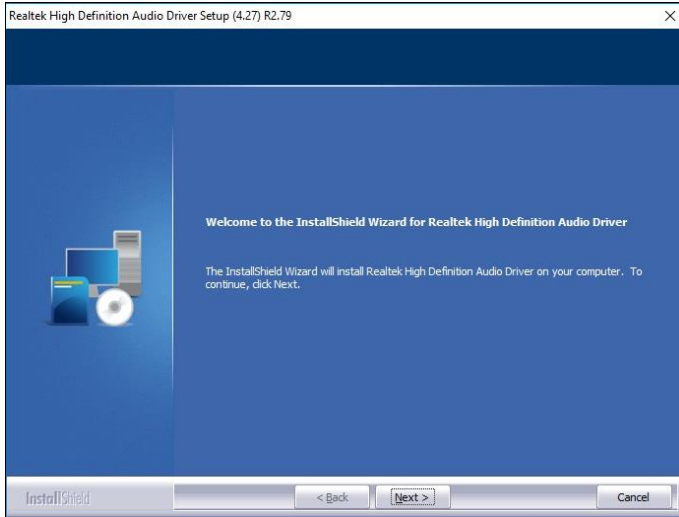

4. On the next screen, click **Next**.

Driver installation is a two-step process:

- 1.) Uninstall current Realtek audio driver.
 - a. Click Next to remove the original Realtek HD Audio Driver in your system .
 - b. Reboot the system
- 2.) Install Realtek audio driver on the system.
 - a. After reboot, setup program will install audio driver automatically.
 - b. Reboot the system

5. When InstallShield Wizard has finished the installation, click **Finish**.

3.5 Intel® ME Drivers

1. Click **Intel** on the left pane and then **Intel(R) Elkhartlake Chipset Drivers** on the right pane.

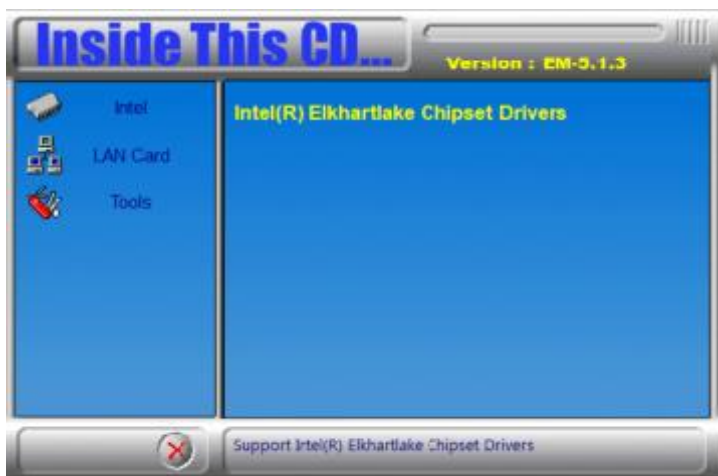

2. Click **Intel(R) ME Drivers** to install the Intel Management Engine Components.



- When the *Welcome* screen appears, click **Next**.

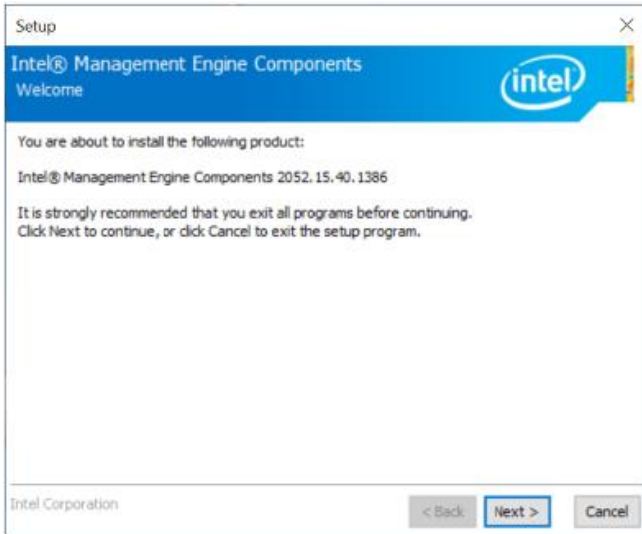

- Accept the license agreement and click **Next**.
- Click **Next** to install to the default folder, or click **Change** to choose another destination folder.

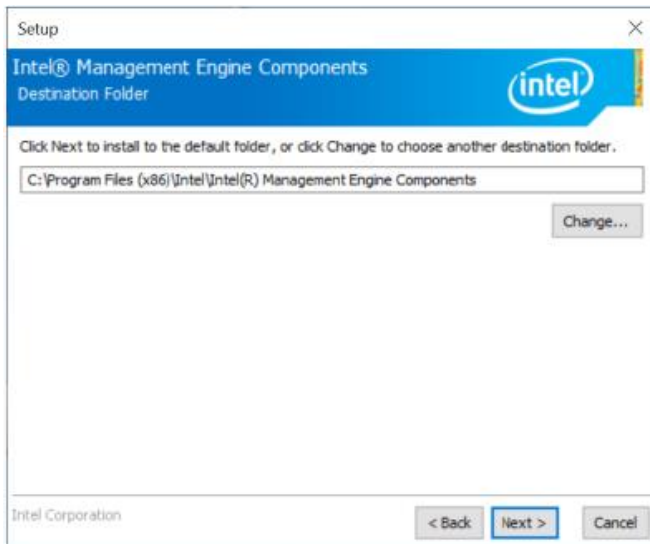

- When the components have been installed, click **Finish**.

3.6 LAN Driver Installation

1. Click **LAN Card** on the left pane and then **Intel LAN Controller Drivers** on the right pane.



2. Click **Intel(R) I21x / I22x Gigabit Network Drivers..**

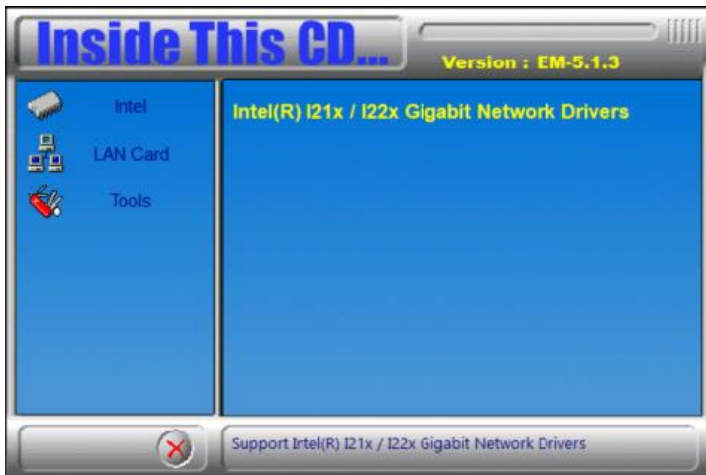

3. On the next screen, click Install Drivers and Software.



4. On the Welcome screen to the install wizard for Intel(R) Network connections, click **Next**.
5. On the Setup Options screen, click **Next**.

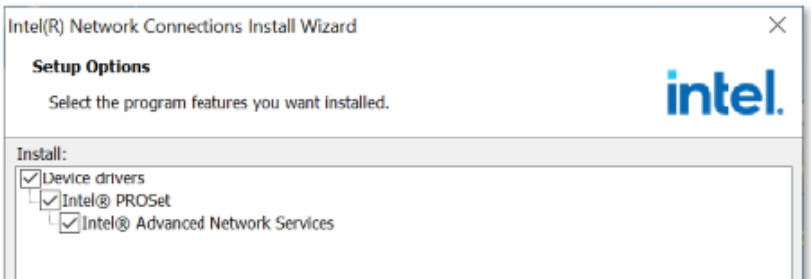

6. On the next screen, click **Install** to begin installation.
7. When Install wizard has completed the installation, click **Finish**.

This page is intentionally left blank.

Chapter 4

BIOS Setup

This chapter describes the different settings available in the AMI BIOS that comes with the board. The topics covered in this chapter are as follows:

- Main Settings
- Advanced Settings
- Chipset Settings
- Security Settings
- Boot Settings
- Save & Exit

4.1 Introduction

The BIOS (Basic Input/Output System) installed in the ROM of your computer system supports Intel® processors. The BIOS provides critical low-level support for standard devices such as disk drives, serial ports and parallel ports. It also provides password protection as well as special support for detailed fine-tuning of the chipset controlling the entire system.

4.2 BIOS Setup

The BIOS provides a Setup utility program for specifying the system configurations and settings. The BIOS ROM of the system stores the Setup utility. When you turn on the computer, the BIOS is immediately activated. Press the key immediately allows you to enter the Setup utility. If you are a little bit late pressing the key, POST (Power On Self Test) will continue with its test routines, thus preventing you from invoking the Setup.

If you still need to enter Setup, restart the system by pressing the "Reset" button or simultaneously pressing the <Ctrl>, <Alt> and <Delete> keys. You can also restart by turning the system Off and back On again.

The following message will appear on the screen:

```
Press <DEL> to Enter Setup
```

In general, press the arrow keys to highlight items, <Enter> to select, the <PgUp> and <PgDn> keys to change entries, <F1> for help, and <Esc> to quit.

When you enter the BIOS Setup utility, the *Main Menu* screen will appear on the screen. The Main Menu allows you to select from various setup functions and exit choices.

Warning: It is strongly recommended that you avoid making any changes to the chipset defaults.

These defaults have been carefully chosen by both AMI and your system manufacturer to provide the absolute maximum performance and reliability. Changing the defaults could make the system unstable and crash in some cases.

4.3 Main Settings



BIOS Setting	Description
System Date	Sets the date. Use the <Tab> key to switch between the DATE elements.
System Time	Set the time. Use the <Tab> key to switch between the TIME elements.

4.4 Advanced Settings

This section allows you to configure, improve your system and allows you to set up some system features according to your preference.

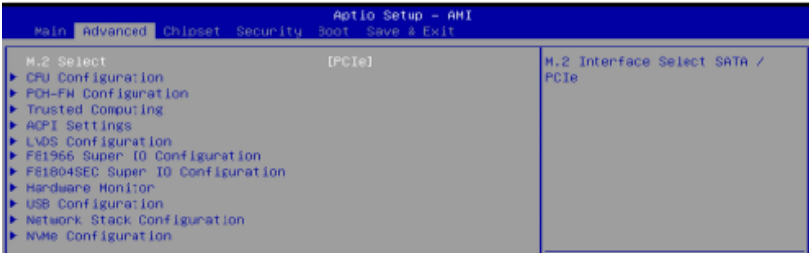

Note: The item **LVDS (eDP/DP) Configuration** is only available for ET880-6425ELV & ET880-6211ELV.

4.4.1 M.2 Setup

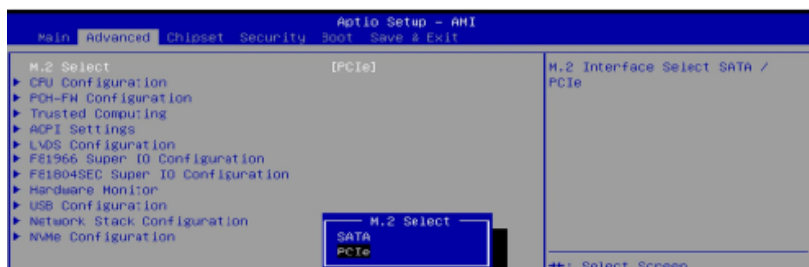

BIOS Setting	Description
M.2 Select	Selects SATA or PCIe interface for M.2.

4.4.2 CPU Configuration



BIOS Setting	Description
Intel (VMX) Virtualization Technology	When enabled, a VMX can utilize the additional hardware capabilities provided by Vanderpool Technology.

4.4.3 PCH-FW Configuration



PCH-FW Configuration: Configure Management Engine Technology Parameters.

ME Firmware Version	15.40.10.2252
ME Firmware Mode	Normal Mode
ME Firmware SKU	Consumer SKU
ME Firmware Status 1	0x90000255
ME Firmware Status 2	0x8B100106
ME State	[Enabled]

BIOS Setting	Description
ME State	When disabled, ME will be put into ME Temporarily Disabled Mode.

4.4.4 Trusted Computing

Advanced		Aptio Setup - AHI	
TPM 2.0 Device Found	7.62	Enables or Disables BIOS support for security device. OS will not show Security Device. TCG EFI protocol and INTIA interface will not be available.	
Firmware Version:	IPX		
Vendor:			
Security Device Support	[Enabled]		
Active PCR banks	SHA256		
Available PCR banks	SHA-1,SHA256		
SHA-1 PCR Bank	[Disabled]		
SHA256 PCR Bank	[Enabled]		
Pending operation	[None]		
Platform Hierarchy	[Enabled]		
Storage Hierarchy	[Enabled]	++: Select Screen !: Select Item Enter: Select +/-: Change Opt. F1: General Help F2: Previous Values Esc: Optimized Defaults	
Endorsement Hierarchy	[Enabled]		
TPM 2.0 UEFI Spec Version	[TCG_2]		
Physical Presence Spec Version	[1.3]		
TPM 2.0 InterfaceType	[TIS]		
Device Select	[Auto]		

BIOS Setting	Description
Security Device Support	Enables / Disables BIOS support for security device. OS will not show security device. TCG EFI protocol and INTIA interface will not be available.
SHA-1 PCR Bank	Enables / Disables SHA-1 PCR Bank.
SHA256 PCR Bank	Enables / Disables SHA256 PCR Bank.
Pending operation	Schedule an operation for the security device. Note: Your computer will reboot during restart in order to change state of security device.
Platform Hierarchy	Enables / Disables platform hierarchy.
Storage/ Endorsement Hierarchy	Enables / Disables storage/endorsement hierarchy.
TPM2.0 UEFI Spec Version	Selects the supported TCG version based on your OS. TCG_1_2 : supports Windows 8 /10. TCG_2 : supports new TCG2 protocol and event format for Windows 10 or later.
Physical Presence Spec Version	Selects to show the PPI Spec Version (1.2 or 1.3) that the OS supports. Note : Some HCK tests might not support 1.3.
Device Select	<p>TPM 1.2 will restrict support to TPM 1.2 devices only. TPM 2.0 will restrict support to TPM 2.0 devices only.</p> <ul style="list-style-type: none"> Auto will support both with the default being set to TPM 2.0 devices if not found, and TPM 1.2 device will be enumerated.

4.4.5 ACPI Settings



BIOS Setting	Description
Enable Hibernation	Enables / Disables the system ability to hibernate (OS/S4 Sleep State). This option may be not effective with some OS.
ACPI Sleep State	Selects an ACPI sleep state (Suspend Disabled or S3) where the system will enter when the Suspend button is pressed.

4.4.6 LVDS Configuration

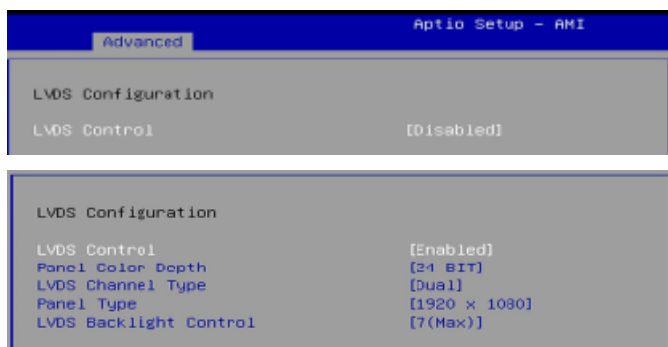

BIOS Setting	Description
LVDS Control	Enables / Disables LVDS.
Panel Color Depth	Options: 18 BIT, 24 BIT
LVDS Channel Type	Options: Single, Dual
Panel Type	Options: 800 x 480 / 800 x 600 / 1024 x 768 / 1280 x 768 / 1280 x 960 / 1280 x 1024 / 1366 x 768 / 1440 x 900 / 1600 x 900 / 1600 x 1200 / 1680 x 1050 / 1920 x 1080 / 1920 x 1200
LVDS Backlight Control	Selects a level of brightness. Options: Level-0 ~ Level-7

4.4.7 F81966 Fintek Super IO Configuration

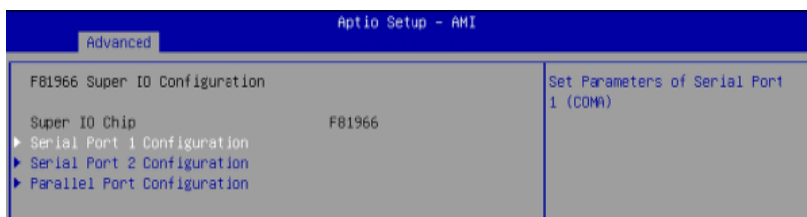

BIOS Setting	Description
Serial Port 1 Configuration	Set parameters of Serial Port 1 (COMA).
Serial Port 2 Configuration	Set parameters of Serial Port 2 (COMB).
Parallel Port Configuration	Set parameters of parallel port (LPT/LPTE).

4.4.7.1 Serial Port 1 Configuration

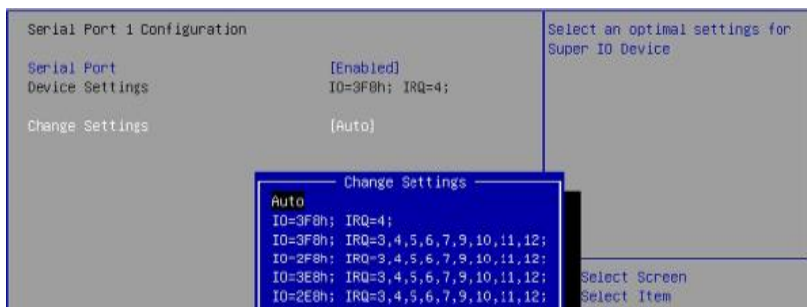

BIOS Setting	Description
Serial Port	Enables / Disables the serial port.
Change Settings	Selects an optimal settings for Super I/O device.

4.4.7.2 Serial Port 2 Configuration



BIOS Setting	Description
Serial Port	Enables / Disables the serial port.
Change Settings	Selects an optimal settings for Super I/O device.

4.4.7.3 Parallel Port Configuration

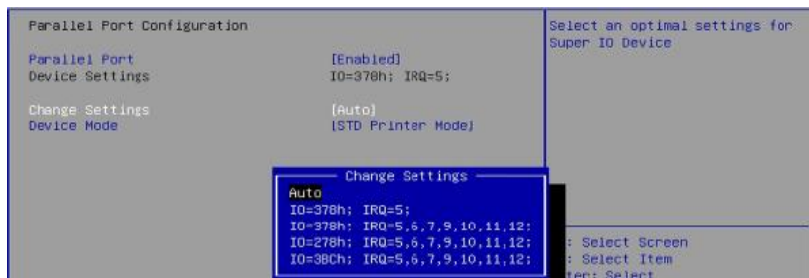

BIOS Setting	Description
Parallel Port	Enables / Disables parallel port (LPT/LPTE)
Change Settings	Selects an optimal settings for Super I/O device. Options: <ul style="list-style-type: none"> • Auto • IO = 378h; IRQ = 5 • IO = 378h; IRQ = 5, 6, 7, 9, 10, 11, 12 • IO = 278h; IRQ = 5, 6, 7, 9, 10, 11, 12 • IO = 3BCh; IRQ =5, 6, 7, 9, 10, 11, 12
Device Mode	Changes the printer port mode. Options: STD Printer Mode / SPP Mode / EPP-1.9 and SPP Mode / EPP-1.7 and SPP Mode / ECP Mode / ECP and EPP 1.9 Mode / ECP and EPP 1.7 Mode

4.4.8 F81804SEC Super IO Configuration



BIOS Setting	Description
Serial Port 1 Configuration	Set parameters of Serial Port 1 (COMA).
Serial Port 2 Configuration	Set parameters of Serial Port 2 (COMB).

4.4.8.1 Serial Port 1 Configuration

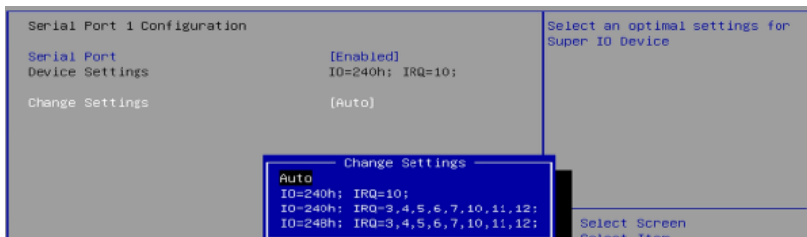

BIOS Setting	Description
Serial Port	Enables / Disables the serial port.
Change Settings	Selects an optimal settings for Super I/O device.

4.4.8.2 Serial Port 2 Configuration

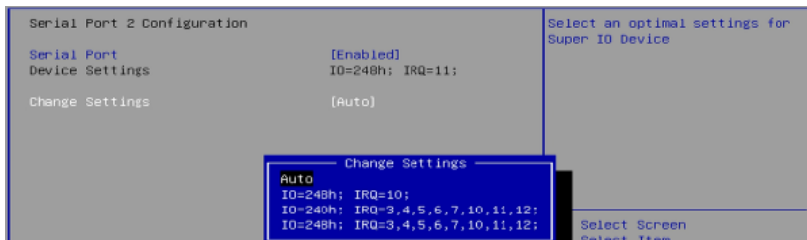

BIOS Setting	Description
Serial Port	Enables / Disables the serial port.
Change Settings	Selects an optimal settings for Super I/O device.

4.4.9 Hardware Monitor

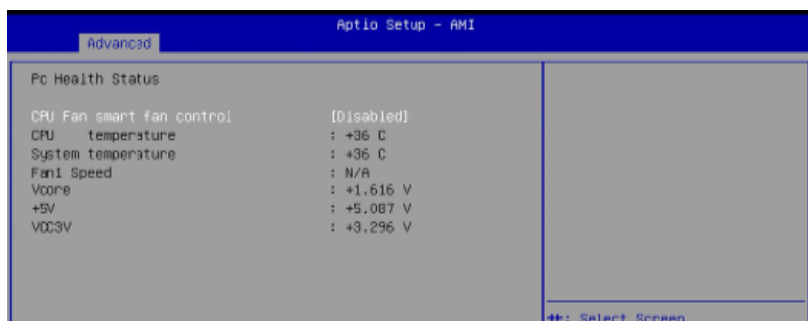

BIOS Setting	Description
CPU Fan Smart Fan Control	Enables / Disables the CPU fan control. Options: Disabled / 50C / 60C / 70C / 80C
Temperatures / Voltages	These fields are the parameters of the hardware monitoring function feature of the motherboard. The values are read-only values as monitored by the system and show the PC health status.

4.4.10 USB Configuration

USB Configuration		Enables Legacy USB support. AUTO option disables legacy support if no USB devices are connected. DISABLE option will keep USB devices available only for EFI applications.
USB Module Version	25	
USB Controllers:	1 XHCI	
USB Devices:	1 Drive, 1 Keyboard	
Legacy USB Support	[Enabled]	
XHCI Hand-off	[Enabled]	
USB Mass Storage Driver Support	[Enabled]	
USB hardware delays and time-outs:		** : Select Screen
USB transfer time-out	[20 sec]	↑↓ : Select Item
Device reset time-out	[20 sec]	Enter: Select
Device power-up delay	[Auto]	←/→ : Change Opt.
Mass Storage Devices:		F1: General Help
KingstonDataTraveler 3.0PMAP	[Auto]	F2: Previous Values
		F3: Optimized Defaults
		F4: Back & Exit

BIOS Setting	Description
Legacy USB Support	<ul style="list-style-type: none"> • Enabled enables Legacy USB support. • Auto disables legacy support if there is no USB device connected. • Disabled keeps USB devices available only for EFI applications.
XHCI Hand-off	This is a workaround for OSES without XHCI hand-off support. The XHCI ownership change should be claimed by XHCI driver.
USB Mass Storage Driver Support	Enables / Disables the support for USB mass storage driver.
USB Transfer time-out	The time-out value (1 / 5 / 10 / 20 secs) for Control, Bulk, and Interrupt transfers.
Device reset time-out	Gives seconds (10 / 20 / 30 / 40 secs) to delay execution of Start Unit command to USB mass storage device.
Device power-up delay	Maximum time the device will take before it properly reports itself to the Host Controller. "Auto" uses default value: for a root port it is 100 ms, for a hub port, the delay is taken from hub descriptor.
KingstonDataTraveler 3.0PMAP	Mass storage device emulation type. "Auto" enumerates devices according to their media format. Optical drives are emulated as "CDROM", drives with no media will be emulated according to a drive type. Options: Auto / Floppy / Forced FDD / Hard Disk / CD-ROM

4.4.11 Network Stack Configuration



BIOS Setting	Description
Network Stack	Enables / Disables UEFI network stack.

4.4.12 NVME Configuration



4.5 Chipset Settings

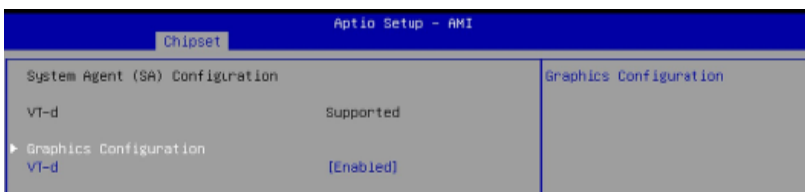
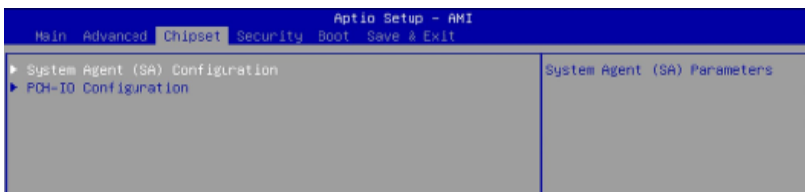

4.5.1 Graphics Configuration

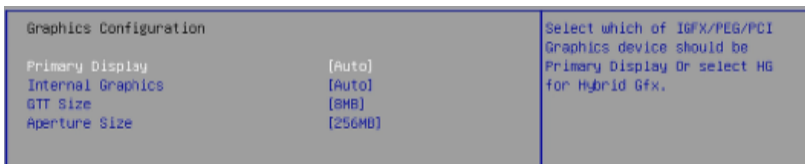

BIOS Setting	Description
Primary Display	Select which of IGFX/PEG/PCI Graphics device should be primary display or select HG for Hybrid Gfx. Options: Auto, IGFX, PEG, PCI
Internal Graphics	Keep IGFX enabled based on the setup options. Options: Auto, Disabled, Enabled
GTT Size	Sets the GTT size as 2 MB, 4 MB, or 8 MB.
Aperture Size	Sets the aperture size as 128 MB, 256 MB, 512 MB, 1024 MB or 2048 MB. Note: Above 4 GB MMIO BIOS assignment is automatically enabled when selecting 2048 MB aperture. To use this feature, disable CSM support.
VT-d	Enable/Disable Vt-d capability

4.5.1 PCH-IO Configuration



BIOS Setting	Description
PCH-IO Configuration	PCH Parameters
SATA Configuration	SATA Devices Options Settings

4.5.2 SATA Configuration:

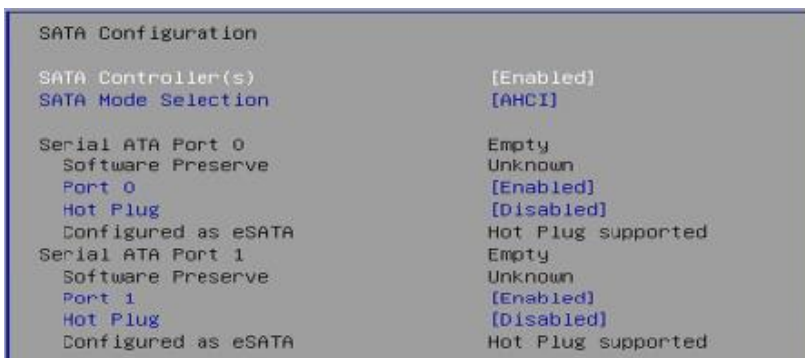

BIOS Setting	Description
SATA Controller(s)	Enables / Disables the SATA device.
SATA Mode Selection	Determines how SATA controller(s) operate.
Serial ATA Ports	Enables / Disables SATA ports.
Hot Plug	Designates the port as Hot Pluggable.

4.6 Security Settings

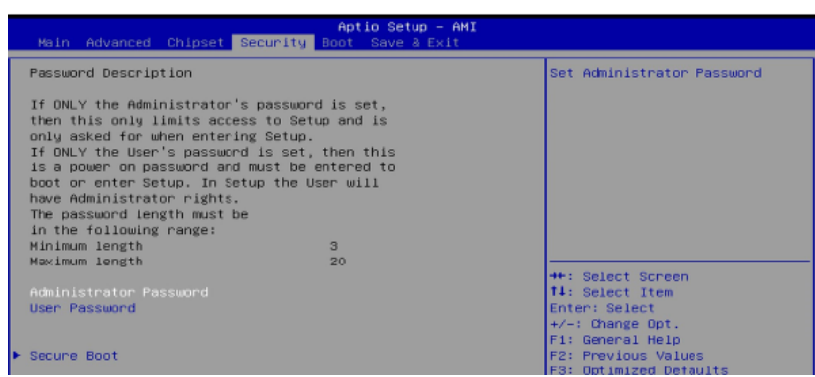

BIOS Setting	Description
Administrator Password	Sets an administrator password for the setup utility.
User Password	Sets a user password.
Secure Boot	Secure Boot Configuration

4.6.1 Secure Boot



BIOS Setting	Description
Secure Boot	Secure Boot feature is Active if Secure Boot is enabled. Platform Key (PK) is enrolled and the system is in User mode. The mode change requires platform reset.
Secure Boot Mode	Secure Boot mode options: Standard or Custom. In Custom mode, Secure Boot policy variables can be configured by a physically present user without full authentication.
Restore Factory Keys	Forces system to user mode. Install factory default Secure Boot key databases.
Key Management	Enables expert users to modify Secure Boot Policy variables without full authentication.

4.6.2 Key Management

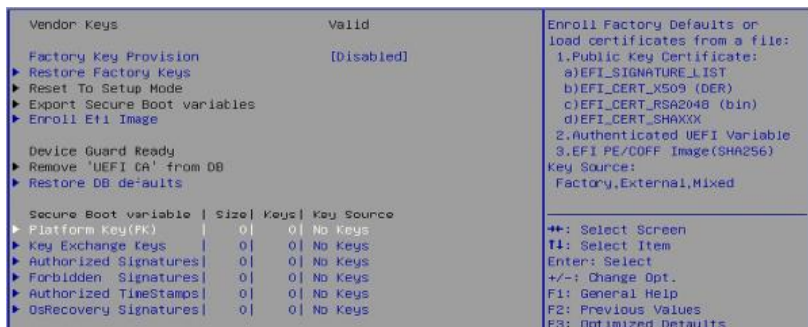

BIOS Setting	Description
Factory Key Provision	Install factory default Secure Boot keys after the platform reset and while the system is in Setup mode.
Restore Factory Keys	Forces system to use mode. Install factory default Secure Boot Key databases.
Enroll Efi Image	Allow the image to run in Secure Boot mode. Enroll SHA256 Hash certificate of a PE image into Authorized Signature Database (db).

4.7 Boot Settings



BIOS Setting	Description
Setup Prompt Timeout	Number of seconds to wait for setup activation key. 65535 (0xFFFF) means indefinite waiting.
Bootup NumLock State	Selects the keyboard NumLock state.
Quiet Boot	Enables / Disables Quiet Boot option.
Fixed Boot Order Priorities	Sets the system boot order.



4.8 Save & Exit Settings

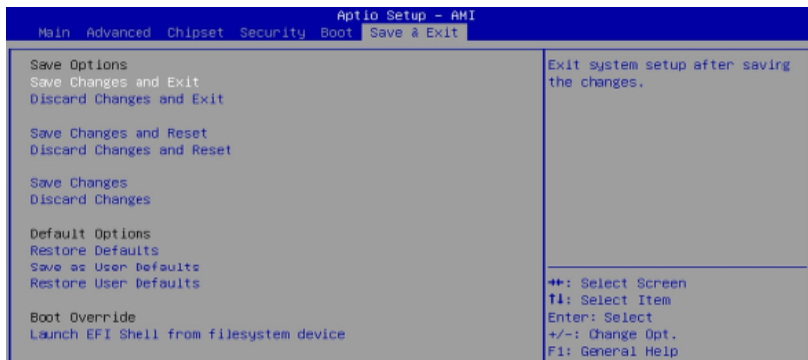

BIOS Setting	Description
Save Changes and Exit	Exits system setup after saving the changes.
Discard Changes and Exit	Exits system setup without saving any changes.
Save Changes and Reset	Resets the system after saving the changes.
Discard Changes and Reset	Resets system setup without saving any changes.
Save Changes	Saves changes done so far to any of the setup options.
Discard Changes	Discards changes done so far to any of the setup options.
Restore Defaults	Restores / Loads defaults values for all the setup options.
Save as User Defaults	Saves the changes done so far as User Defaults.
Restore User Defaults	Restores the user defaults to all the setup options.
Launch EFI Shell from filesystem device	Attempts to Launch EFI Shell application (Shell.efi) from one of the available filesystem devices.

Appendix

This section provides the mapping addresses of peripheral devices and the sample code of watchdog timer configuration.

A. I/O Port Address Map

Each peripheral device in the system is assigned a set of I/O port addresses which also becomes the identity of the device. The following table lists the I/O port addresses used.

Address	Device Description
0x00000A00-0x00000A0F	Motherboard resources
0x00000A10-0x00000A1F	Motherboard resources
0x00000A20-0x00000A2F	Motherboard resources
0x0000002E-0x0000002F	Motherboard resources
0x0000004E-0x0000004F	Motherboard resources
0x00000061-0x00000061	Motherboard resources
0x00000063-0x00000063	Motherboard resources
0x00000065-0x00000065	Motherboard resources
0x00000067-0x00000067	Motherboard resources
0x00000070-0x00000070	Motherboard resources
0x00000080-0x00000080	Motherboard resources
0x00000092-0x00000092	Motherboard resources
0x000000B2-0x000000B3	Motherboard resources
0x00000680-0x0000069F	Motherboard resources
0x0000164E-0x0000164F	Motherboard resources
0x00000378-0x0000037F	Printer Port (LPT1)
0x000003F8-0x000003FF	Communications Port (COM1)
0x000002F8-0x000002FF	Communications Port (COM2)
0x00000240-0x00000247	Communications Port (COM3)
0x00000248-0x0000024F	Communications Port (COM4)
0x00001800-0x000018FE	Motherboard resources
0x00004090-0x00004097	Standard SATA AHCI Controller
0x00004080-0x00004083	Standard SATA AHCI Controller
0x00004060-0x0000407F	Standard SATA AHCI Controller
0x00000020-0x00000021	Programmable interrupt controller
0x00000024-0x00000025	Programmable interrupt controller
0x00000028-0x00000029	Programmable interrupt controller

Address	Device Description
0x0000002C-0x0000002D	Programmable interrupt controller
0x00000030-0x00000031	Programmable interrupt controller
0x00000034-0x00000035	Programmable interrupt controller
0x00000038-0x00000039	Programmable interrupt controller
0x0000003C-0x0000003D	Programmable interrupt controller
0x000000A0-0x000000A1	Programmable interrupt controller
0x000000A4-0x000000A5	Programmable interrupt controller
0x000000A8-0x000000A9	Programmable interrupt controller
0x000000AC-0x000000AD	Programmable interrupt controller
0x000000B0-0x000000B1	Programmable interrupt controller
0x000000B4-0x000000B5	Programmable interrupt controller
0x000000B8-0x000000B9	Programmable interrupt controller
0x000000BC-0x000000BD	Programmable interrupt controller
0x000004D0-0x000004D1	Programmable interrupt controller
0x00001854-0x00001857	Motherboard resources
0x00000000-0x00000CF7	PCI Express Root Complex
0x00000D00-0x0000FFFF	PCI Express Root Complex
0x0000EFA0-0x0000EFBF	Intel(R) SMBus Controller - 4B23
0x00002000-0x000020FE	Motherboard resources
0x00003000-0x00003FFF	Intel(R) PCI Express Root Port #5 - 4B3D
0x00004000-0x0000403F	Intel(R) UHD Graphics
0x00000040-0x00000043	System timer
0x00000050-0x00000053	System timer

B. Interrupt Request Lines (IRQ)

Peripheral devices use interrupt request lines to notify CPU for the service required. The following table shows the IRQ used by the devices on board.

Level	Function
IRQ 0	System timer
IRQ 3	Communications Port (COM2)
IRQ 4	Communications Port (COM1)
IRQ 10	Communications Port (COM3)
IRQ 11	Communications Port (COM4)
IRQ 16	High Definition Audio Controller
IRQ 55 ~ IRQ 204	Microsoft ACPI-Compliant System
IRQ 256 ~ IRQ 511	Microsoft ACPI-Compliant System
IRQ 4294967282	Intel(R) Management Engine Interface #1
IRQ 4294967283~85	Intel(R) Ethernet Controller I226-IT
IRQ 4294967286~91	Intel(R) I210 Gigabit Network Connection
IRQ 4294967292	Intel(R) USB 3.10 eXtensible Host Controller - 1.20 (Microsoft)
IRQ 4294967293	Intel(R) UHD Graphics
IRQ 4294967294	Standard SATA AHCI Controller

C. Watchdog Timer Configuration

The Watchdog Timer (WDT) is used to generate a variety of output signals after a user programmable count. The WDT is suitable for use in the prevention of system lock-up, such as when software becomes trapped in a deadlock. Under these sorts of circumstances, the timer will count to zero and the selected outputs will be driven.

Under normal circumstance, you will need to restart the WDT at regular intervals before the timer counts to zero.

Sample Code:

```
//-----
//
// THIS CODE AND INFORMATION IS PROVIDED "AS IS" WITHOUT WARRANTY OF ANY
// KIND, EITHER EXPRESSED OR IMPLIED, INCLUDING BUT NOT LIMITED TO THE
// IMPLIED WARRANTIES OF MERCHANTABILITY AND/OR FITNESS FOR A PARTICULAR
// PURPOSE.
//
//-----
#include <dos.h>
#include <conio.h>
#include <stdio.h>
#include <stdlib.h>
#include "F81804.H"
//-----
int main (int argc, char *argv[]);
void EnableWDT(int);
void DisableWDT(void);
//-----
int main (int argc, char *argv[])
{
    unsigned char bBuf;
    unsigned char bTime;
    char **endptr;

    char SIO;

    printf("Fintek 81804 watch dog program\n");
    SIO = Init_F81804();
    if (SIO == 0)
    {
        printf("Can not detect Fintek 81804, program abort.\n");
        return(1);
    }
    //if (SIO == 0)

    if (argc != 2)
    {
        printf(" Parameter incorrect!!\n");
        return (1);
    }
}
```

```

bTime = strtol (argv[1], endptr, 10);
printf("System will reset after %d seconds\n", bTime);

if (bTime)
{
    EnableWDT(bTime); }
else
{
    DisableWDT();}
return 0;
}
//-----
void EnableWDT(int interval)
{
    unsigned char bBuf;

    bBuf = Get_F81804_Reg(0x2B);
    bBuf &= (~0x20);
    Set_F81804_Reg(0x2B, bBuf);           //Enable WDTO

    Set_F81804_LD(0x07);                 //switch to logic device 7
    Set_F81804_Reg(0x30, 0x01);         //enable timer

    bBuf = Get_F81804_Reg(0xF5);
    bBuf &= (~0x0F);
    bBuf |= 0x52;
    Set_F81804_Reg(0xF5, bBuf);         //count mode is second

    Set_F81804_Reg(0xF6, interval);     //set timer

    bBuf = Get_F81804_Reg(0xFA);
    bBuf |= 0x01;
    Set_F81804_Reg(0xFA, bBuf);         //enable WDTO output

    bBuf = Get_F81804_Reg(0xF5);
    bBuf |= 0x20;
    Set_F81804_Reg(0xF5, bBuf);         //start counting
}
//-----
void DisableWDT(void)
{
    unsigned char bBuf;

    Set_F81804_LD(0x07);                 //switch to logic device 7

    bBuf = Get_F81804_Reg(0xFA);
    bBuf &= ~0x01;
    Set_F81804_Reg(0xFA, bBuf);         //disable WDTO output

    bBuf = Get_F81804_Reg(0xF5);
    bBuf &= ~0x20;
    bBuf |= 0x40;
    Set_F81804_Reg(0xF5, bBuf);         //disable WDT
}
//-----
//

```

```

// THIS CODE AND INFORMATION IS PROVIDED "AS IS" WITHOUT WARRANTY OF ANY
// KIND, EITHER EXPRESSED OR IMPLIED, INCLUDING BUT NOT LIMITED TO THE
// IMPLIED WARRANTIES OF MERCHANTABILITY AND/OR FITNESS FOR A PARTICULAR
// PURPOSE.
//
//-----
#include "F81804.H"
#include <dos.h>
//-----
unsigned int F81804_BASE;
void Unlock_F81804 (void);
void Lock_F81804 (void);
//-----
unsigned int Init_F81804(void)
{
    unsigned int result;
    unsigned char ucDid;

    F81804_BASE = 0x4E;
    result = F81804_BASE;

    ucDid = Get_F81804_Reg(0x20);
    if (ucDid == 0x07)                //Fintek 81804
    {
        goto Init_Finish;
    }

    F81804_BASE = 0x2E;
    result = F81804_BASE;

    ucDid = Get_F81804_Reg(0x20);
    if (ucDid == 0x07)                //Fintek 81804
    {
        goto Init_Finish;
    }

    F81804_BASE = 0x00;
    result = F81804_BASE;

Init_Finish:
    return (result);
}
//-----
void Unlock_F81804 (void)
{
    outputb(F81804_INDEX_PORT, F81804_UNLOCK);
    outputb(F81804_INDEX_PORT, F81804_UNLOCK);
}
//-----
void Lock_F81804 (void)
{
    outputb(F81804_INDEX_PORT, F81804_LOCK);
}
//-----
void Set_F81804_LD( unsigned char LD)
{
    Unlock_F81804();
    outputb(F81804_INDEX_PORT, F81804_REG_LD);
    outputb(F81804_DATA_PORT, LD);
    Lock_F81804();
}
}

```

iBASE

```
//-----  
void Set_F81804_Reg( unsigned char REG, unsigned char DATA)  
{  
    Unlock_F81804();  
    outputb(F81804_INDEX_PORT, REG);  
    outputb(F81804_DATA_PORT, DATA);  
    Lock_F81804();  
}  
//-----  
unsigned char Get_F81804_Reg(unsigned char REG)  
{  
    unsigned char Result;  
    Unlock_F81804();  
    outputb(F81804_INDEX_PORT, REG);  
    Result = inportb(F81804_DATA_PORT);  
    Lock_F81804();  
    return Result;  
}  
//-----  
  
//-----  
//  
// THIS CODE AND INFORMATION IS PROVIDED "AS IS" WITHOUT WARRANTY OF ANY  
// KIND, EITHER EXPRESSED OR IMPLIED, INCLUDING BUT NOT LIMITED TO THE  
// IMPLIED WARRANTIES OF MERCHANTABILITY AND/OR FITNESS FOR A PARTICULAR  
// PURPOSE.  
//  
//-----  
#ifndef F81804_H  
#define F81804_H 1  
//-----  
#define F81804_INDEX_PORT (F81804_BASE)  
#define F81804_DATA_PORT (F81804_BASE+1)  
//-----  
#define F81804_REG_LD 0x07  
//-----  
#define F81804_UNLOCK 0x87  
#define F81804_LOCK 0xAA  
//-----  
unsigned int Init_F81804(void);  
void Set_F81804_LD( unsigned char);  
void Set_F81804_Reg( unsigned char,  
unsigned char); unsigned char  
Get_F81804_Reg( unsigned char);  
//-----  
#endif // F81804_H
```