

BYARM-181-PC

User Manual

Revision	Release Date
V0.1	2015/02/03

Copyright © 2013 IBASE Technology Inc. All Rights Reserved.

No part of this manual, including the products and software described in it, may be reproduced, transmitted, transcribed, stored in a retrieval system, or translated into any language in any form or by any means, except documentation kept by the purchaser for backup purposes, without the express written permission of IBASE Technology INC. (“IBASE”).

Products and corporate names mentioned in this manual may or may not be registered trademarks or copyrights of their respective companies, and are used for identification purposes only. All trademarks are the property of their respective owners.

Every effort has been made to ensure that the contents of this manual are correct and up to date. However, the manufacturer makes no guarantee regarding the accuracy of its contents, and reserves the right to make changes without prior notice.

Table of Contents

Setting up your system.....	iii
Care during use.....	iv
Acknowledgments	v
CHAPTER 1 INTRODUCTION.....	1
1.1 General Description	1
1.2 System Specifications.....	2
1.2.1 Hardware Specifications.....	2
1.2.2 Dimensions	3
1.2.3 I/O View	4
1.3 Packing List	4
1.4 Installation	5
1.4.1 Installing SD card.....	5
CHAPTER 2 MOTHERBOARD INTRODUCTION.....	6
2.1 Introduction	6
I/O View.....	7
Board Dimensions	7
2.2 Setting Jumpers.....	8
2.3 Connectors on IB102	14

Safety Information

Your BYARM-181-PC is designed and tested to meet the latest standards of safety for information technology equipment. However, to ensure your safety, it is important that you read the following safety instructions

Setting up your system

- Read and follow all instructions in the documentation before you operate your system.
- Do not use this product near water.
- Set up the system on a stable surface. Do not secure the system on any unstable plane.
- Do not place this product on an unstable cart, stand, or table. The product may fall, causing serious damage to the product.
- Slots and openings on the chassis are for ventilation. Do not block or cover these openings. Make sure you leave plenty of space around the system for ventilation. **Never insert objects of any kind into the ventilation openings.**
- This system should be operated from the type of power indicated on the marking label. If you are not sure of the type of power available, consult your dealer or local power company.
- Use this product in environments with ambient temperatures between 0°C and 50°C.
- If you use an extension cord, make sure that the total ampere rating of the devices plugged into the extension cord does not exceed its ampere rating.
- DO NOT LEAVE THIS EQUIPMENT IN AN ENVIRONMENT WHERE THE STORAGE TEMPERATURE MAY GO BELOW -20° C OR ABOVE 60° C. THIS COULD DAMAGE THE EQUIPMENT. THE EQUIPMENT SHOULD BE IN A CONTROLLED ENVIRONMENT.

Care during use

- Do not walk on the power cord or allow anything to rest on it.
- Do not spill water or any other liquids on your system.
- When the system is turned off, a small amount of electrical current still flows. Always unplug all power, and network cables from the power outlets before cleaning the system.
- If you encounter the following technical problems with the product, unplug the power cord and contact a qualified service technician or your retailer.
 - The power cord or plug is damaged.
 - Liquid has been spilled into the system.
 - The system does not function properly even if you follow the operating instructions.
 - The system was dropped or the cabinet is damaged.

Lithium-Ion Battery Warning

CAUTION: Danger of explosion if battery is incorrectly replaced. Replace only with the same or equivalent type recommended by the manufacturer. Dispose of used batteries according to the manufacturer's instructions.

NO DISASSEMBLY

The warranty does not apply to the products that have been disassembled by users.

WARNING**HAZARDOUS MOVING PARTS**

KEEP FINGERS AND OTHER BODY PARTS AWAY

Acknowledgments

- AMI is a registered trademark of AMI Software International, Inc.
- AMD and ATI are registered trademarks of AMD Corporation.
- Microsoft Windows is a registered trademark of Microsoft Corporation.
- FINTEK is a registered trademark of FINTEK Electronics Corporation.
- REALTEK is a registered trademark of REALTEK Electronics Corporation.
- All other product names or trademarks are properties of their respective owners.

CHAPTER 1 INTRODUCTION

1.1 General Description

BYARM-181-PC, an 18.5" ARM based all-in-one panel PC, utilizes the Freescale I.MX6 Cortex A9 Processor that provide high computing performance with low power consumption.

Well suited for industrial applications, BYARM-181-PC comes with 1GB DDR3 memory and one 4GB eMMC and one SD card slot for data storage. It has one Gigabit Ethernet LAN PoE, an RS-232/485 port and USB OTG. The unit is equipped with 5-side IP65 protection and supports Android 4.x and 12V DC single power input.



BYARM-181-PC Overview

1.2 System Specifications

1.2.1 Hardware Specifications

Model Name	BYARM-181-PC
System Mainboard	IB102
CPU	Freescle I.MX6 Cortex A9 Solo (1 Cores @ 1GHz)
Memory	1GB DDR3 memory
I/O Interface	1x USB (USB Host. A-Type) 1x USB OTG (mini USB B Type) 1x RS-232/485 via RJ45 connector 1x GbE LAN POE 802.3at 1x Power reset button Switch 1x 12V DC-in power jack
Storage	1x 4GB eMMC onboard 1x SD card slot
Expansion Slots	None
Power Supply	12V DC input/POE
LCD Size	18.5" TFT LCD
LCD Color	16.7M
LCD Resolution	1366 x 768
LCD Brightness	300
LCD View Angle (H°/V°)	170/160
Backlight MTBF	50,000 hrs
Touch Screen	Projected capacitive touch
Construction	Black aluminum front bezel and black steel back cover
Mounting	VESA 75x75/100x100 mm
Dimensions (W)x(D)x(H) mm	520 x 341 x 68.3
Operating Temperature	0°C~ 50°C
Storage Temperature	-20°C ~ 60°C
Relative Humidity	10%~90% (non-condensing)
Protection Class	IP65 front bezel
Certification	CE/FCC Class B
Operating System Support	Android4.X

•This specification is subject to change without prior notice.

1.2.2 Dimensions

BYARM-181-PC

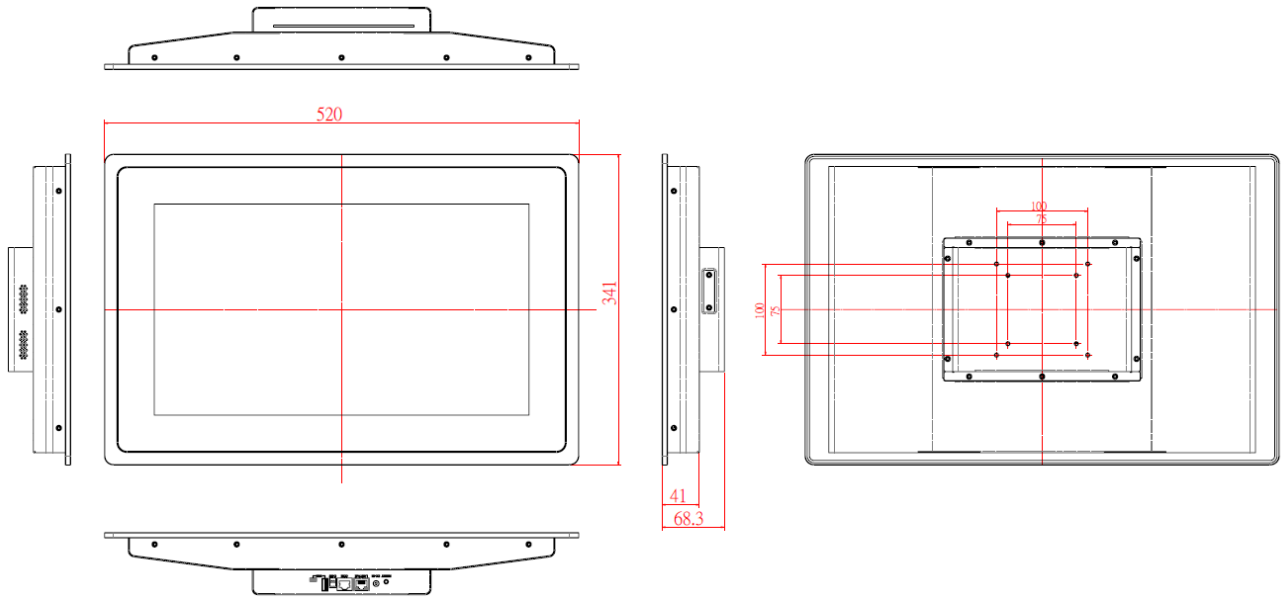

1.2.3 I/O View

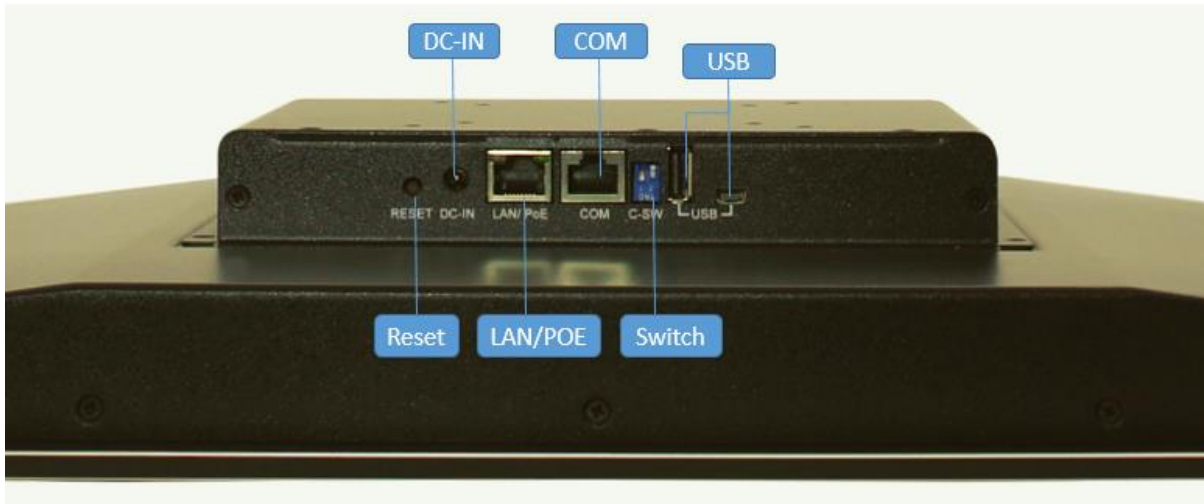

1.3 Packing List

Part No.	Description	Quantity
1	60W power adaptor	1 pc

1.4 Installation

1.4.1 Installing SD card

1. Loosen the two screws as shown in the picture.

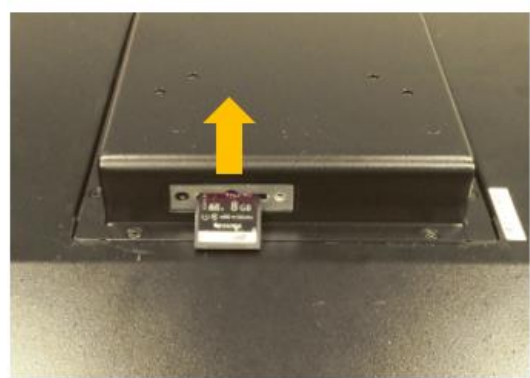
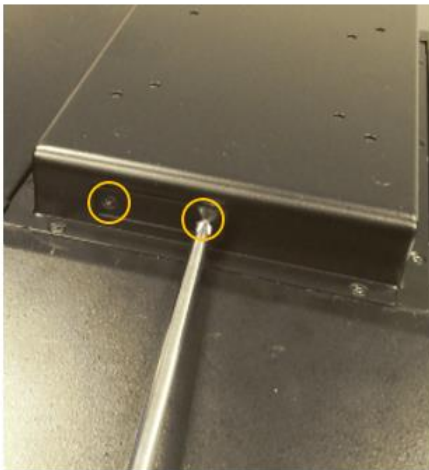

CHAPTER 2 MOTHERBOARD INTRODUCTION

2.1 Introduction

The IB102 i.MX6 SBC comes with extended consumer-grade Freescale i.MX6 Solo Core Cortex-A9 1GHz CPU. LVDS, POE+, and light bar design to bring you the scalability and flexibility you need. The device offers 3D graphics acceleration, while also supporting numerous peripherals, including DDR3, RS232/422/485 port and USB OTG that are well suited for industrial applications.

Specifications – Mainboard	
Product Name	IB102
Form Factor	150mm x 165mm
CPU Type	Freescale i.MX6 Solo Core Coretex-A9 on Board
CPU Speed	1GHz
Memory	DDR3 1GB on Board
VGA Controller	IPU v3H IPU Engine
Edge IO	10/100/1000 LAN x1 (RJ45 connector with POE+ support) USB x 1 (USB Host. A-Type) USB OTG x 1 (mini AB type) COM1 RS-232/422/485 x 1 Dip switch x 1 (for 232/485 selection) SD card slot x 1 Reset button x1 12V DC-IN Jack x 1,
Internal Headers	LVDS Connector x 1 GPIO x (10pin, pitch 2.0 with 3.3V, refer to RP100) Audio pin Header x3 I2C connector x1 Battery: BR2032 with socket
Expansion Slots	miniPCIE x1 (with USB support)
Others	LEDs light bar x 1 (3xGPIO pin control Red, Orange and Green)
Operating Temperature	0~60 degree
SW Support	1. Android 4.3

This specification is subject to change without prior notice.

I/O View

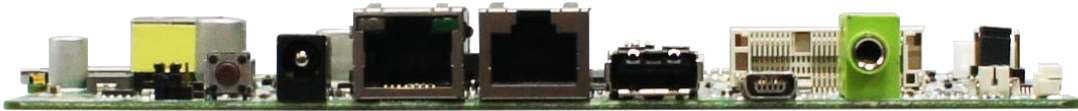

Board Dimensions

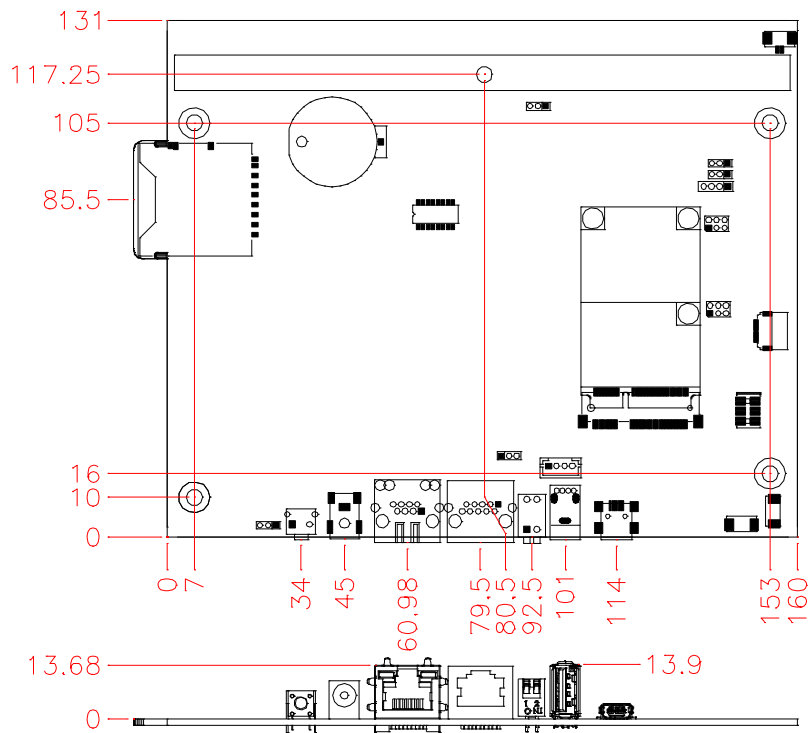

2.2 Setting Jumpers

[Important] Please check the jumpers, DIP, buttons and switches on IB102 before doing the panel connection and boot up.

Jumpers are used on IB102 to select various settings and features according to your needs and applications. Contact your supplier if you have doubts about the best configuration for your needs. The following lists the connectors on IB102 and their respective functions.

Jumper Locations on IB102

Top Side

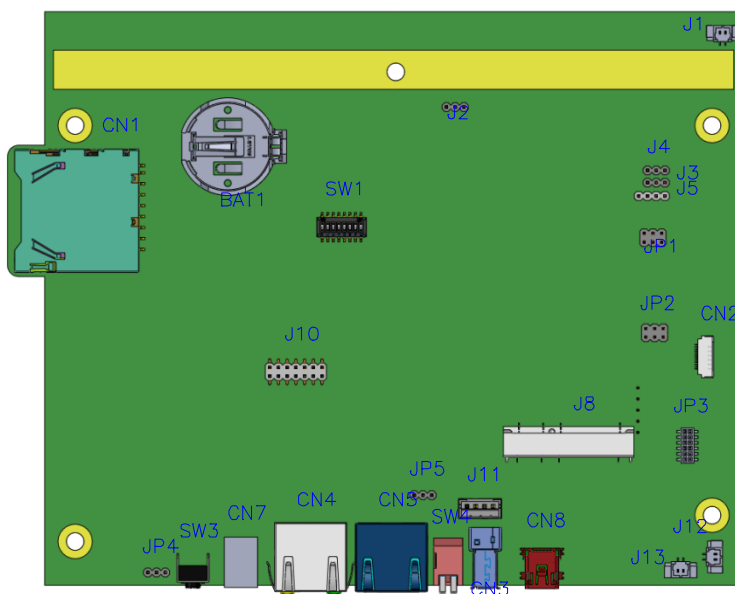

Bottom Side



JP1: Touch Pad Wire Setting 2.0mm

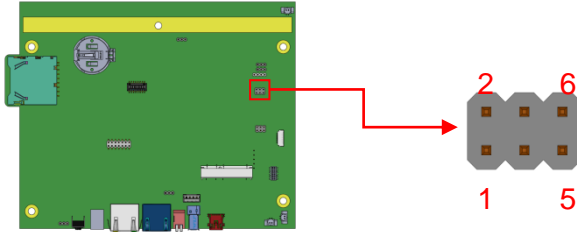

JP1	Setting	Function
	Pin 1-2 Short/Open	4 or 8 wire/5 wire (Default)
	Pin 3-4 Short/Open	4 or 8 wire/5 wire (Default)
	Pin 5-6 Short/Open	4 or 8 wire/5 wire (Default)

JP2: Touch USB/UART Mode Setting 2.0mm

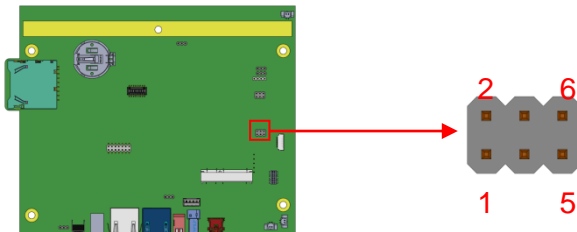

JP2	USB Setting*	Function
	Pin 1-3 Short/Closed	USB
	Pin 2-4 Short/Closed	
JP2	UART Setting	Function
	Pin 3-5 Short/Closed	UART*
	Pin 2-4 Short/Closed	Baud rate 19200*
	Pin 4-6 Short/Closed	Baud rate 9600

JP3: Program Interface (E-CALL 0519-03-2161-120) (Factory use only)

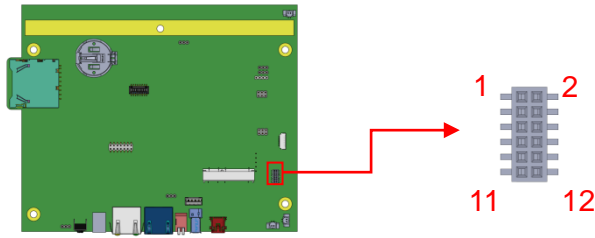

JP4: System reset/GPIO Mode Setting 2.0mm

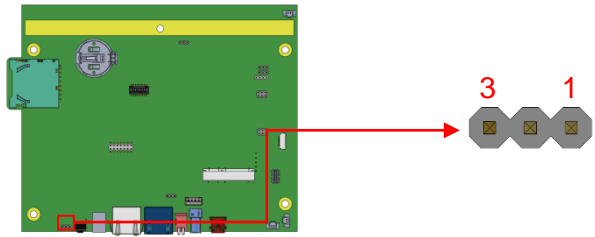

JP4	Setting	Function
	Pin 1-2 Short/Closed	GPIO
	Pin 2-3 Short/Closed	System Reset (Default)

JP5, SW4 (S2): RS-232/422/485 Mode Selection 2.0mm

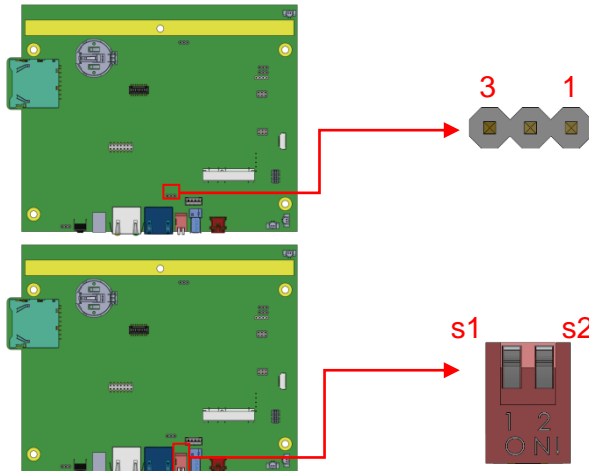

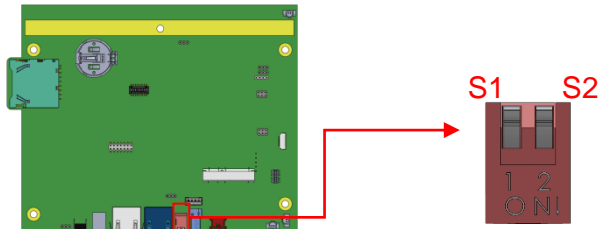

COM1 Mode	SW4 (S2)	JP5
RS-232	Off (Default)	2-3 Short (Default)
RS-485	On	2-3 Short
RS-422	Off	1-2 Short

SW4 (S1): RS-422/485 Device Termination Selection



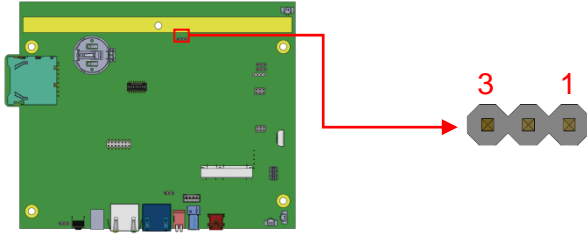

SW4 (S1)	Device Mode
On	None Terminal (Default)
Off	Terminal

J2: BL Voltage Setting 2.0mm

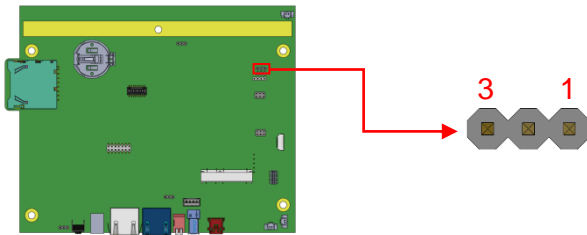
J2	Setting	Panel Voltage
	Pin 1-2 Short/Closed	5V (default)
	Pin 2-3 Short/Closed	12V

J3: BL ADJ Level Setting 2.0mm

J3	Setting	Panel Voltage
	Pin 1-2 Short/Closed	5V
	Pin 2-3 Short/Closed	3.3V (default)

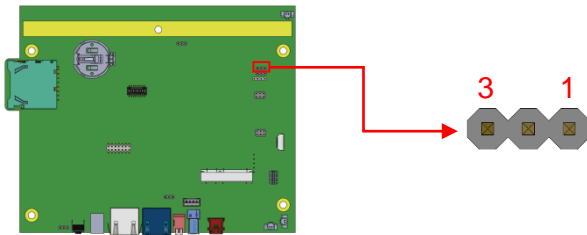
J4: LVDS Panel Power Selection 2.0mm

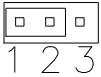
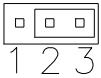
J4	Setting	Panel Voltage
 1 2 3	Pin 1-2 Short/Closed	5V
 1 2 3	Pin 2-3 Short/Closed	3.3V (default)

2.3 Connectors on IB102

CN1: SD Card Connector

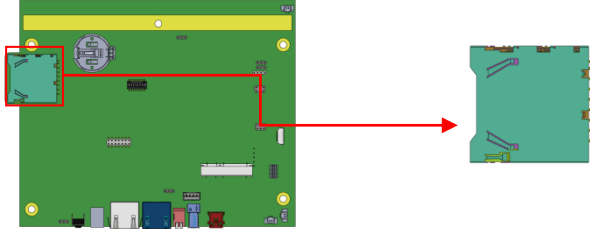

CN2: Capacitor Touch Pad Connector (ENTERY 7083K-F12N-04L)

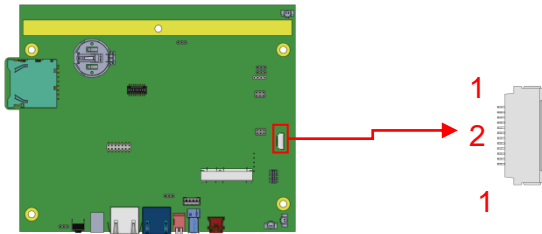

Pin #	Signal Name
1	GND
2	NC
3	NC
4	NC
5	NC
6	GND
7	SDA
8	SCL
9	NC
10	INT
11	3.3V
12	3.3V

CN3: USB 2.0 Connector

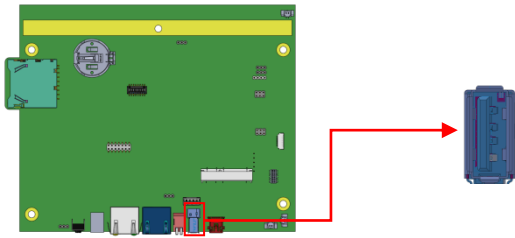

CN4: 10/100/1000Mb LAN (PoE+ supported)

This RJ45 LAN connector supports PoE+ function.



CN5: COM1 RJ45 Connector

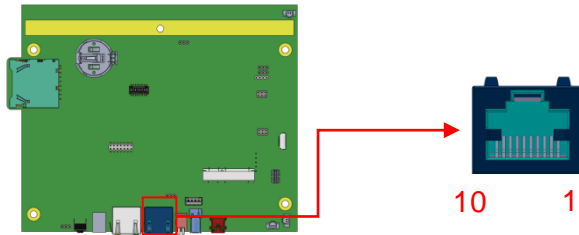

Pin #	Signal Name
1	COM1 DSR, Data set ready
2	GND
3	GND
4	COM1 RXD, Receive data
5	COM1 TXD, Transmit data
6	COM1 DCD, Data carrier detect
7	COM1 DTR, Data terminal ready
8	COM1 CTS, Clear to send
9	COM1 RTS, Request to send
10	Boot by SD card detection

COM1 is jumperless for RS-232, RS-422 and RS-485 and configured with SW4 (S2) and JP5 Selection.

[

Pin #	Signal Name		
	RS-232	R2-422	RS-485
1	DSR	NC	NC
2	Ground	Ground	Ground
3	Ground	Ground	Ground
4	RX	TX+	DATA+
5	TX	RX+	NC
6	DCD	TX-	DATA-
7	DTR	RX-	NC
8	CTS	NC	NC
9	RTS	NC	NC
10	NC	NC	NC

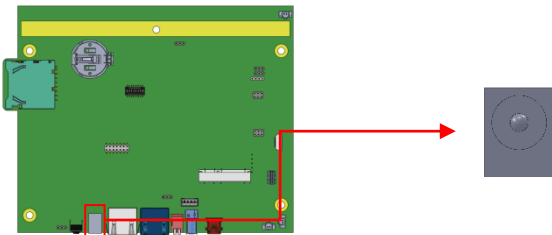
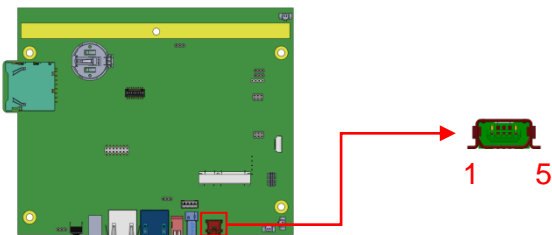
CN7: +12V DC-IN Power Connector**CN8: Mini USB OTG Connector**

Pin #	Signal Name
1	+5V
2	D-
3	D+
4	ID
5	GND

Note: CN8 will be used for USB device when ID is floating.

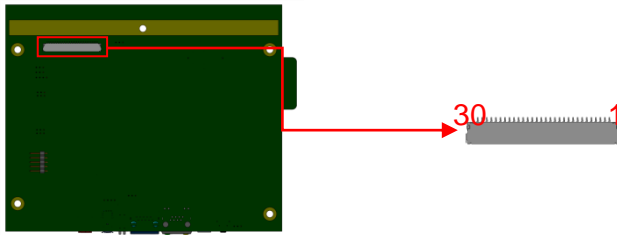
CN9: LVDS Connector (HRS DF19G-30P-1H(54))

Pin #	Signal Name
1	NC
2	LCD_VDD
3	LCD_VDD
4	NC
5	TX0-
6	TX0+
7	GND
8	TX1-
9	TX1+
10	GND
11	TX2-
12	TX2+
13	GND
14	CLK-
15	CLK+
16	GND
17	TX3-
18	TX3+
19	GND
20	GND
21	GND
22	GND
23	GND
24	NC
25	BKLT_ADJ
26	BKLT_EN
27	NC
28	BKLT_VCC
29	BKLT_VCC
30	BKLT_VCC

J1: Mic Connector (WT04M-30003-02032)

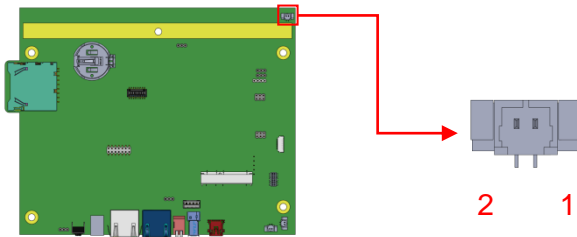

Pin #	Signal Name
1	MIC Input
2	GND

**J5: COM2 RS232 Connector, Debug Port Connector 2.0mm
(Factory use only)**

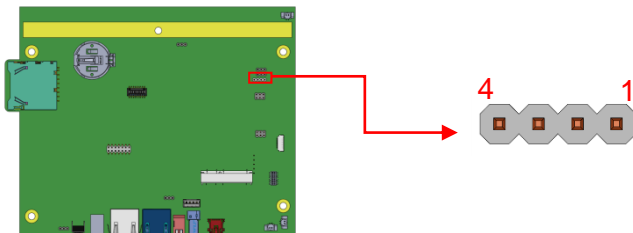

Pin #	Signal Name
1	COM2 RXD, Receive Data
2	COM2 TXD, Transmit Data
3	GND
4	NC

J7: Resistive Touch Panel Connector 2.5mm

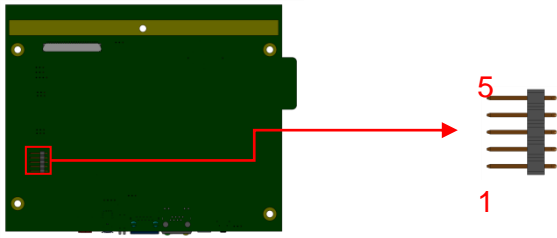

Pin #	Signal Name
1	Touch XP
2	Touch XM
3	Touch SG
4	Touch YP
5	Touch YM

J8: Mini PCI-E Connector

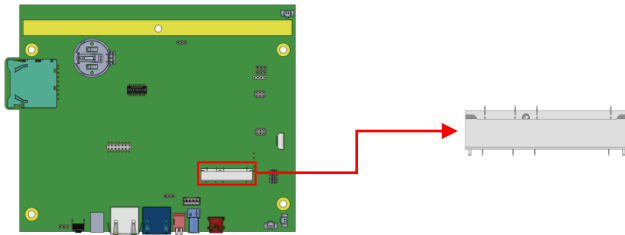

J10: Digital In/Out Connector 2.0mm

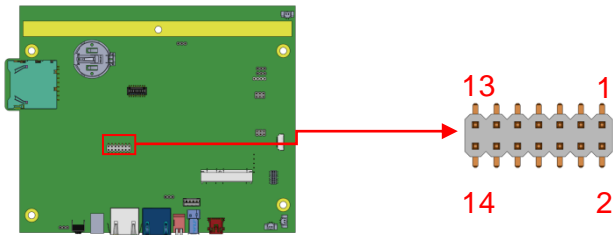

Signal Name	Pin #	Pin #	Signal Name
3.3V	1	2	GPIO2
GPIO1	3	4	GPIO5
GPIO3	5	6	GPIO8
GPIO7	7	8	Reset
GPIO9	9	10	Watch Dog
GPIO10	11	12	GPIO11
GPIO12	13	14	GND

J11: USB2.0 Connector (JST B4B-PH-K-S)

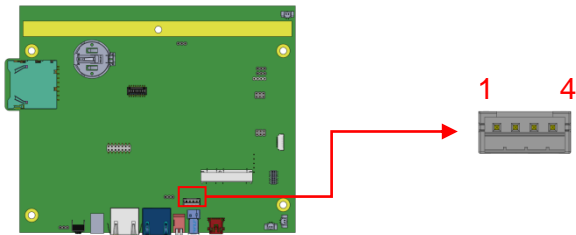

Pin #	Signal Name
1	+5V
2	D-
3	D+
4	GND

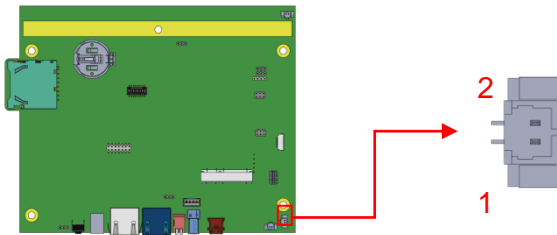
J12: Speaker Right-Out Connector (WT04M-30003-02032)

Pin #	Signal Name
1	SPEAKER_RIGH T+
2	SPEAKER_RIGH T-

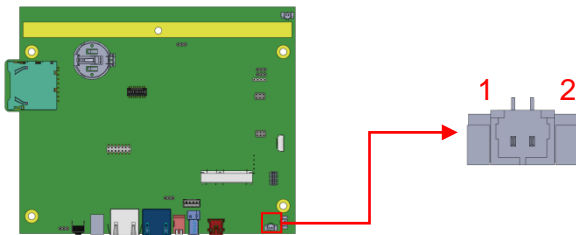
J13: Speaker Left-Out Connector (WT04M-30003-02032)

Pin #	Signal Name
1	SPEAKER_LEFT-
2	SPEAKER_LEFT +

SW3: System Reset Button