

ACS413
Advanced Compact System with
13th Gen Intel® Core™ Processors
(i7 / i5 / i3 / U300E)

User's Manual

Version 1.1
May 2026



Copyright

© 2026 IBASE Technology, Inc. All rights reserved.

No part of this publication may be reproduced or transmitted in any form without prior written consent from IBASE.

Disclaimer

IBASE reserves the right to make changes and improvements to the products described in this document without prior notice. Every effort has been made to ensure the accuracy of this document. However, IBASE does not guarantee this document is error-free. IBASE assumes no liability for incidental or consequential damages arising from misuse of the product or information in this document, nor for any infringements of rights of third parties, which may result from its use.

Trademarks

All trademarks and brand names are used for identification purposes only and are the property of their respective owners.

Compliance



This product has passed CE compliance testing and conforms to applicable EU directives. In a residential environment, this device may cause radio interference. Users may need to take corrective measures.



This product complies with the limits for a Class B digital device, pursuant to Part 15 of the FCC Rules. It generates, uses, and can radiate radio frequency energy. Improper installation or use may cause harmful interference to radio communications.

WEEE



This product must not be disposed of as household waste, in accordance with the EU directive on Waste Electrical and Electronic Equipment (WEEE - 2012/19/EU). Follow local regulations for electronic waste disposal or return it to a designated recycling facility.

RoHS Compliance



This product complies with RoHS 2 restrictions, which prohibit the use of certain hazardous substances in electrical and electronic equipment. The following substances must not exceed the specified concentrations:

- Hexavalent chromium: 1,000 ppm
- Polybrominated biphenyls (PBBs): 1,000 ppm
- Polybrominated diphenyl ethers (PBDEs): 1,000 ppm
- Cadmium: 100 ppm
- Mercury: 1,000 ppm
- Lead: 1,000 ppm
- Bis(2-ethylhexyl) phthalate (DEHP): 1,000 ppm
- Butyl benzyl phthalate (BBP): 1,000 ppm
- Dibutyl phthalate (DBP): 1,000 ppm
- Diisobutyl phthalate (DIBP): 1,000 ppm

Important Safety Information

Carefully read the precautions before using the device.

Environmental conditions:

- Lay the device horizontally on a stable and solid surface.
- Make sure you leave plenty of space around the device for ventilation.
- Use this product in environments with ambient temperatures of $-10^{\circ}\text{C} \sim 50^{\circ}\text{C}$.
- Do not store this device in environments below -20°C or above 80°C .

Care for your iBASE products:

- Turn off the device and unplug all cables to prevent electrical hazards.
- Use neutral cleaning agents or diluted alcohol to clean the device chassis with a cloth. Then wipe the chassis with a dry cloth.
- Vacuum the dust with a computer vacuum cleaner to prevent the air vent or slots from being clogged.



WARNING

Attention during use:

- Do not use this product near water.
- Do not spill water or any other liquids on your device.
- Do not place heavy objects on top of the device.
- Operate this device from the type of power indicated on the marking label. If you are not sure of the type of power available, consult your distributor or local power company.
- Ensure the correct power supply voltage is used.
- Do not walk on the power cord or place objects on it.
- If you use an extension cord, make sure that the total ampere rating of the product plugged into the extension cord does not exceed its limits.
- Do not touch the heat sink while the system is running.



CAUTION! Hot surface. Do not touch.

•

Avoid Disassembly

Do not disassemble, repair or make any modification to the device. Disassembly, modification, or any attempt at repair may cause hazards, including injury or property damage, and will void any warranty.



CAUTION

Danger of explosion if internal lithium-ion battery is replaced by an incorrect type. Replace only with the same or equivalent type recommended by the manufacturer. Dispose of used batteries according to the manufacturer's instructions.

Warranty Policy

- **IBASE standard products:**

24-month (2-year) warranty from the date of shipment. If the shipment date cannot be verified, the product serial number will be used to estimate the shipping date.

- **Third-party components:**

12-month (1-year) warranty from delivery for the third-party components that are not manufactured by IBASE, such as CPU, CPU cooler, memory, storage devices, power adapter, panel and touchscreen.

- * Products that fail due to misuse, accident, improper installation or unauthorized repair shall be treated as out of warranty and customers shall be billed for repair and shipping charges.

Technical Support & Services

1. Visit the IBASE website at www.ibase.com.tw to find the latest information about the product.
2. If you need any further assistance from your distributor or sales representative, prepare the following product information and a detailed description of the issue.
 - Product model name
 - Product serial number
 - Detailed description of the problem
 - Any error messages (text or screenshots, if available)
 - The arrangement of the peripherals
 - Software in use (such as OS and application software, including the version numbers)
3. If repair service is required, please log in to the RMA system of the website or contact your distributor or sales representative for assistance.

Table of Contents

Chapter 1 General Information	1
1.1 Introduction	2
1.2 Features	2
1.3 Packing List	3
1.4 Optional Accessories	3
1.5 Specifications	3
1.6 Product View – ACS413 and IP302	5
1.7 Dimensions	9
Chapter 2 Hardware Configuration	9
2.1 Installation	12
2.1.1 Memory Installation / Replacement.....	13
2.1.2 M.2 Cards Installation / Replacement	14
2.1.3 Wi-Fi / 5G / 4G Antenna Installation	15
2.1.4 IP302 Expansion Card.....	15
2.1.5 Mounting Installation	16
2.1.6 Pinout for COM Ports, DC-In Power Connector & Line-Out Jack	17
2.2 Setting the Jumpers	19
2.3 MBE330 Motherboard	20
2.4 Jumpers Quick Reference.....	21
2.4.1 JP1: M.2 B-Key Support Type	22
2.4.2 JP2: AT/ATX Mode Selection	22
2.4.3 JP3: Clear ME	23
2.4.4 JP4: Clear RTC	23
2.4.5 JP5: Flash Descriptor Security Override	23
2.5 Connectors Quick Reference	24
2.5.1 CN1: SIM-1 Card Connector.....	25
2.5.2 CN2: SATA Connector.....	25
2.5.3 CN16: SIM-2 Card Connector.....	25
2.5.4 CN3: COM1 / 2 Connector.....	26
2.5.5 CN4: Audio Combo Connector	26
2.5.6 CN5: USB Stack 3.0 Connector.....	27
2.5.7 CN6: HDMI 2.0 Connector	27
2.5.8 CN7: USB 3.2 Connector.....	27
2.5.9 CN8, CN10: DisplayPort Connector.....	28
2.5.10 CN9: USB 3.2 Connector.....	28
2.5.11 CN11, CN13: I226V LAN Jack.....	29

2.5.12	CN12: I226LM LAN Connector	29
2.5.13	CN14, CN15: USB Type C Connector	30
2.5.14	SW1: Power Button / RTC_RST	30
2.5.15	J2: M.2 B-Key Connector	31
2.5.16	J3: Digital IO Connector	31
2.5.17	J4: SATA Power Connector	32
2.5.18	J5: M.2 M-Key Connector (Support PCIe_X1 / SATA)	32
2.5.19	J6: SPI Debug Header	32
2.5.20	J7, J8: SO-DIMM Socket	33
2.5.21	J9: M.2 E-Key [Support USB2.0 & PCIe] (for Wi-Fi module)	33
2.5.22	J10: M.2 M-Key Connector	33
2.5.23	J11, J12: PD JTAG	34
2.5.24	J13: SPI Debug Header	34
2.5.25	J14: AT On/Off Switch	35
2.5.26	J15: USB 2.0 Pin Header	35
2.5.27	J16: Reset Header	36
2.5.28	J17: Remote PWR_BTN Header	37
2.5.29	J18: DC_IN Connector (3-pin terminal block)	37
2.5.30	LED1: 4 x LED indicators	37
2.5.31	PCIE1: PCI-Express (x16) Slot (used with IP305, IP302)	38
2.5.32	PCIE2: PCI-Express (x4) Slot (used with IP305, IP302)	38
2.5.33	SYS_FAN1: For System Fan to PCIe_X4 Slot	39
2.5.34	CPU_FAN1: For CPU PWM Fan	39
Chapter 3 Driver Installation		41
3.1	Introduction	42
3.2	Intel® Chipset Software Installation Utility	42
3.3	VGA Driver Installation	44
3.4	HD Audio Driver Installation	46
3.5	LAN Driver Installation	48
3.6	Intel® Management Engine Components Driver Installation	50
Chapter 4 BIOS Setup		51
Appendix		71
A.	I/O Port Address Map	72
B.	Interrupt Request Lines (IRQ)	74
C.	Watchdog Timer Configuration	75

Chapter 1

General Information

The information provided in this chapter includes:

- Introduction
- Features
- Specifications
- Product View
- Dimensions

1.1 Introduction

The ACS413 is a fanless, industrial-grade compact box PC powered by 13th Gen Intel® Core™ i7 / i5 / i3 processors and Intel® U300E, designed for high-performance edge computing and industrial applications. Built on the MBE330 proprietary board, the ACS413 delivers strong compute capability, flexible expansion, and reliable operation in space-constrained environments.

This compact system supports dual-channel DDR5-5200 SO-DIMM memory up to 96 GB, multiple high-speed storage options, and rich I/O connectivity. It features six USB 3.2 ports, two USB Type-C ports with DisplayPort Alternate Mode and up to 60 W Power Delivery per port, three 2.5GbE LAN ports, and versatile serial communication with isolated RS-232/422/485 COM ports. Display support includes HDMI, dual DP++, and USB-C DP output, allowing up to four independent displays.

For expansion and connectivity, the ACS413 provides four internal M.2 sockets supporting NVMe storage, Wi-Fi/Bluetooth, and 4G/5G communication with dual Nano SIM slots, as well as a removable 2.5-inch HDD/SSD bay. Designed for industrial reliability, it operates from a +24 V DC power input with over/under/reverse voltage protection and supports TPM 2.0 hardware security. Mounting options include VESA, wall mount, and optional DIN-rail, making the ACS413 well-suited for industrial automation, smart factory, edge AI, and embedded computing applications.

1.2 Features

- Compact Expandable System for MBE330 proprietary board
- 13th Gen Intel® Core™ i7 / i5 / i3 / U300E processors
- Supports dual-channel DDR5-5200 SO-DIMM
- 2x USB Type-C (DP Alternate Mode), supports up to 60W per port
- Removable drive bay for 2.5-inch HDD/SSD
- 2x PCIe (x4) expansion slot via IP302 Riser card
- Over/Under/Reverse voltage protection
- Supports DIN-rail mount and wall mount
- Supports TPM 2.0 hardware security
- Isolated COM 1 and COM 2
- HDMI, 2x DP++, and 2x USB-C (DP Alternate Mode), supporting up to 4 independent displays
- 6x USB 3.2
- 4x internal M.2 sockets supporting NVMe storage, Wi-Fi/Bluetooth, and 4G/5G communication with dual Nano SIM slots

1.3 Packing List

Your product package should include the items listed below. If any of the items below is missing, contact the distributor or the dealer from whom you purchased the product.

- ACS413 series Box PC
- Manuals & Driver download instructions
- DC-IN Dinkle bare wire converter
- Power SW Dinkle bare wire converter

1.4 Optional Accessories

- EU AC Power Cord (183 cm)
- UK AC Power Cord (183 cm)
- US AC Power Cord (183 cm)
- JP AC Power Cord (183 cm)
- DIN-Rail Kit (with screws)
- 180W 24V Power Adapter

1.5 Specifications

ACS413 Specifications	
Processor	<ul style="list-style-type: none">• Intel® U300E Processor (Five-Core @ 4.3GHz)• Intel® Core™ i3-1315UE Processor (Six-Core @ 4.5GHz)• Intel® Core™ i5-1335UE Processor (Ten-Core @ 4.5GHz)• Intel® Core™ i7-1365UE Processor (Ten-Core @ 4.9GHz)
Mainboard	<ul style="list-style-type: none">• MBE330 proprietary board
Memory	<ul style="list-style-type: none">• 2x DDR5-5200 SO-DIMM, up to 96GB
Rear Panel External I/O	<ul style="list-style-type: none">• 1x HDMI 2.0• 2x DP++ 1.4• 2x USB Type-C (DP Alternate Mode, up to 60W PD per port)• 6x USB 3.2• 3x RJ45 2.5GbE LAN• 1x Combo Audio Jack• 3-Pin Bare-Wire DC-IN (+24V)
Front Panel External I/O	<ul style="list-style-type: none">• Power Button (Tact Switch)• Clear Button (Tact Switch)
Serial Interface	<ul style="list-style-type: none">• Isolated COM 1 and COM 2 (RS-232/422/485, selectable via BIOS)• Optional COM 3~6 via riser card

Expansion Slots	<ul style="list-style-type: none"> • 1x M.2 2280 M-Key (SATA or PCIe x1 NVMe) • 1x M.2 2280 M-Key (PCIe x1 NVMe, no SATA) • 1x M.2 2030 E-Key (USB 2.0 & PCIe x1) for Wi-Fi / Bluetooth • 1x M.2 3052 B-Key (USB 2.0 / 3.0 & PCIe x1) for 4G / 5G • Dual Nano SIM slots • 2x PCI-E (x4) slot
Storage	<ul style="list-style-type: none"> • 2x M.2 (M-Key) NVMe SSD (Supports RAID Mode) • 1x SATA interface for 2.5-inch HDD / SSD • Removable 2.5-inch HDD / SSD drive bay
Construction	<ul style="list-style-type: none"> • Aluminum and SGCC
Chassis Color	<ul style="list-style-type: none"> • Silver / Gray
Mounting	<ul style="list-style-type: none"> • VESA 100 x 100 mm • Wall mount • Optional DIN-rail mount kit
Dimensions	<ul style="list-style-type: none"> • 275 mm (W) x 140 mm (D) x 117 mm (H)
Weight	<ul style="list-style-type: none"> • 3.5 kg
Power Input	<ul style="list-style-type: none"> • +24V DC • Over / Under / Reverse voltage protection
Supported O.S.	<ul style="list-style-type: none"> • Microsoft Windows 10, Windows 11 • Linux Kernel 4.x or later
Certification	<ul style="list-style-type: none"> • CE / FCC Class B

Environment	
Operating Temperature	<ul style="list-style-type: none"> • -10°C to 60°C (with airflow) • -10°C to 50°C (without airflow)
Storage Temperature	<ul style="list-style-type: none"> • -20°C to 80°C
Relative Humidity	<ul style="list-style-type: none"> • 5% to 90% @ 50°C (non-condensing)

All specifications are subject to change without prior notice.

1.6 Product View – ACS413 and IP302



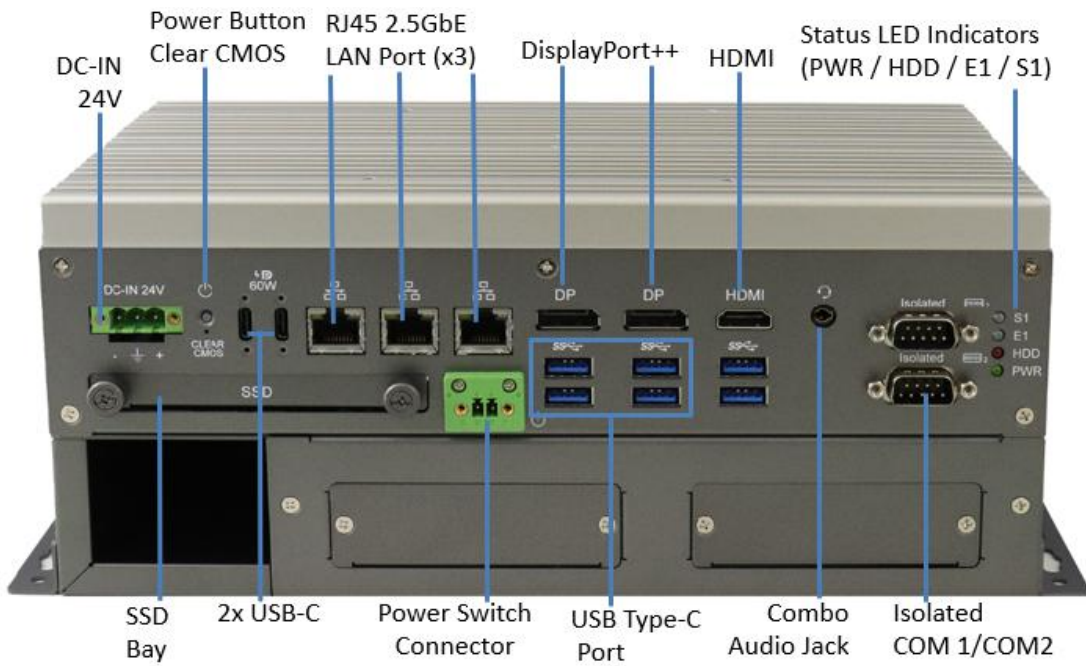

Rear External I/O

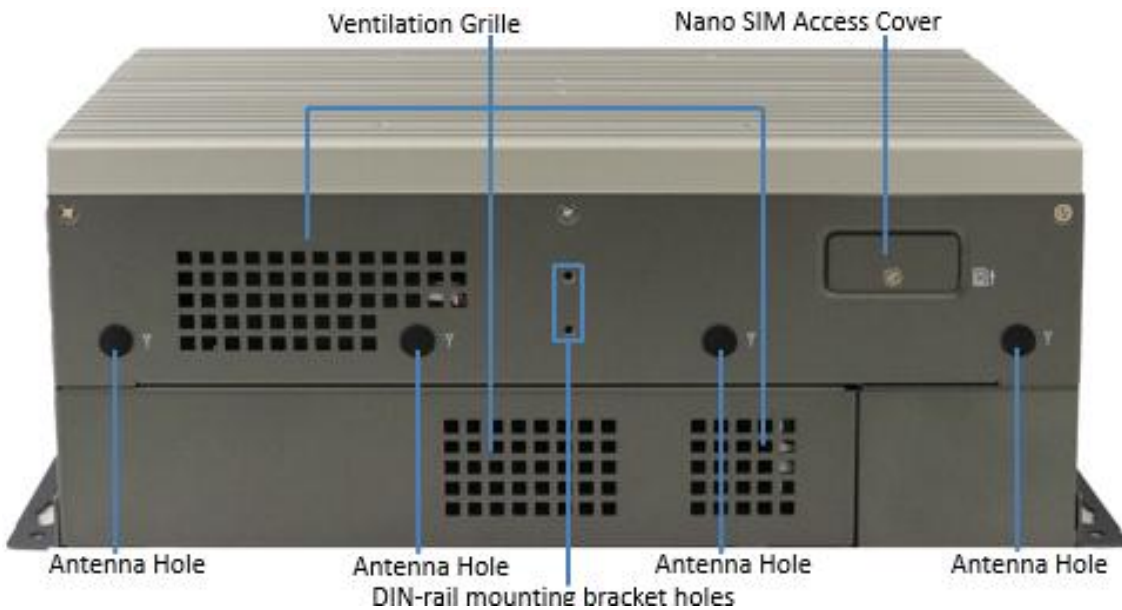

Front External I/O

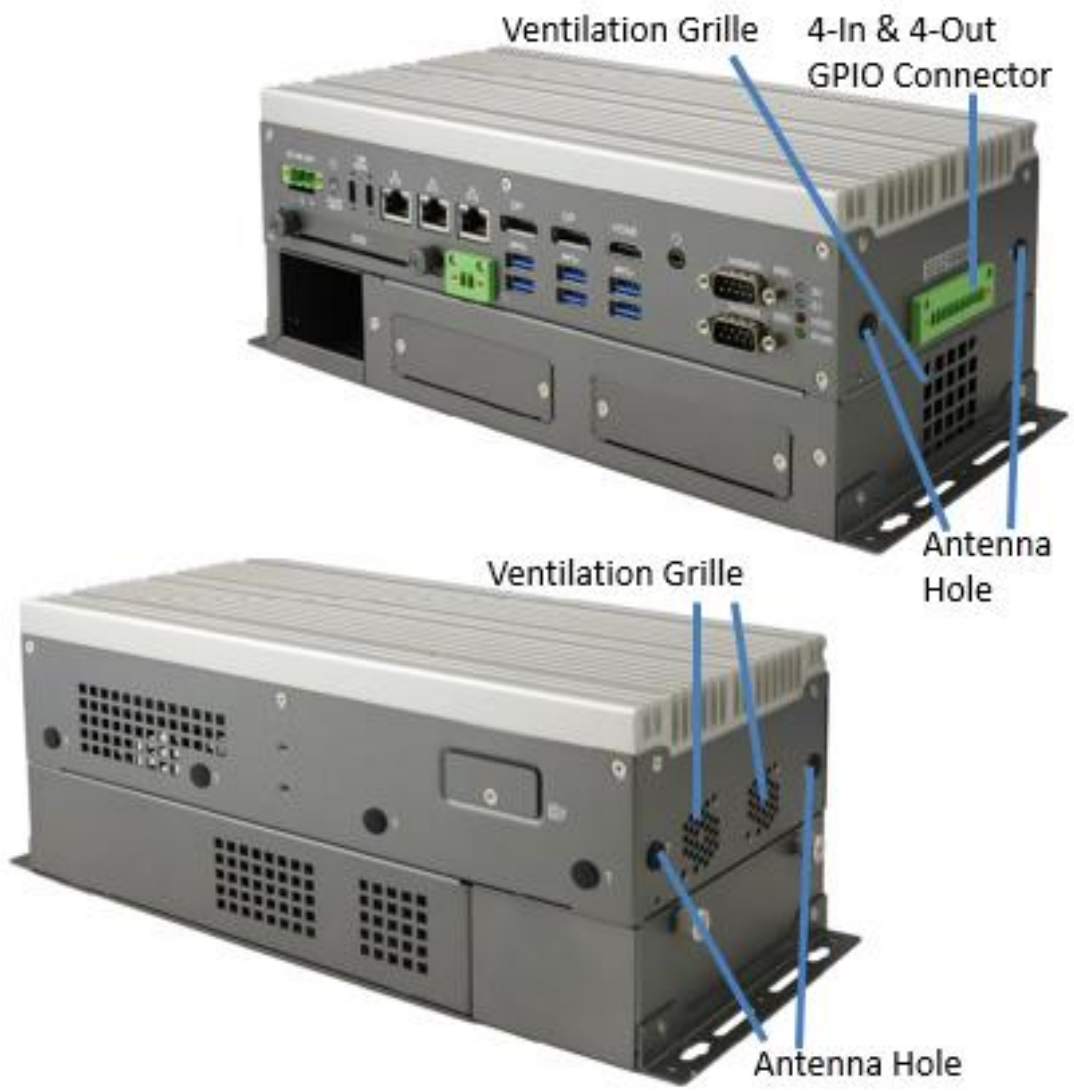

**Remarks: 2x PCIe (x4) expansion slot via IP302 Riser card
Supports different types of Fieldbus through expansion slot, such as CAN Bus, COM and LAN.**

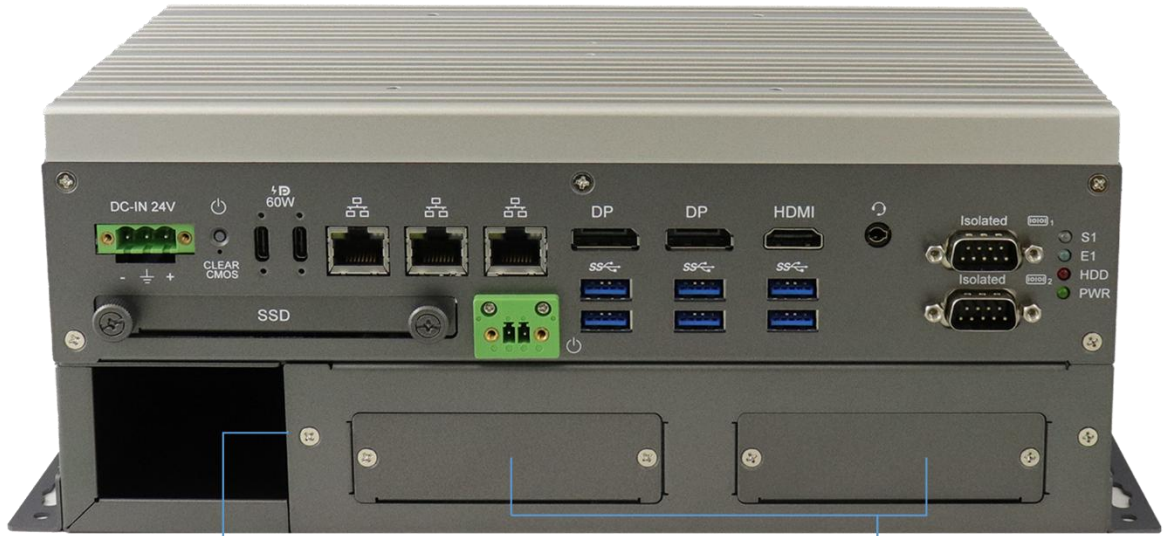

2x PCIe (x4) expansion slot via IP302 Riser card.

Supports different types of Fieldbus through expansion slot. Such as CAN Bus, COM and LAN...

IP302 Expansion Card

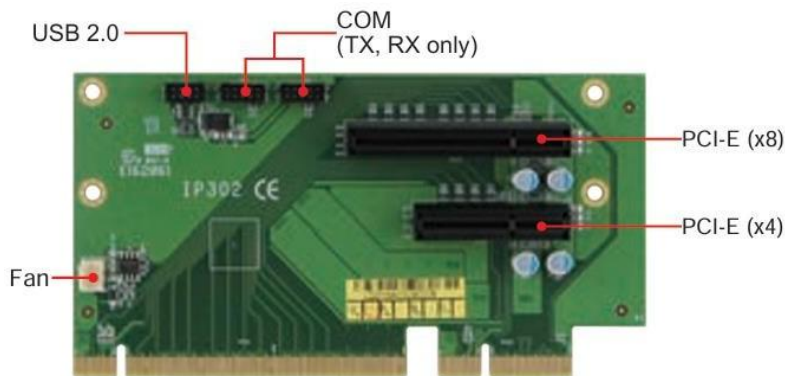

Remarks: The IP302 slots both have PCIe(x4) signals only for ACS413 system.

1.7 Dimensions

Unit: mm

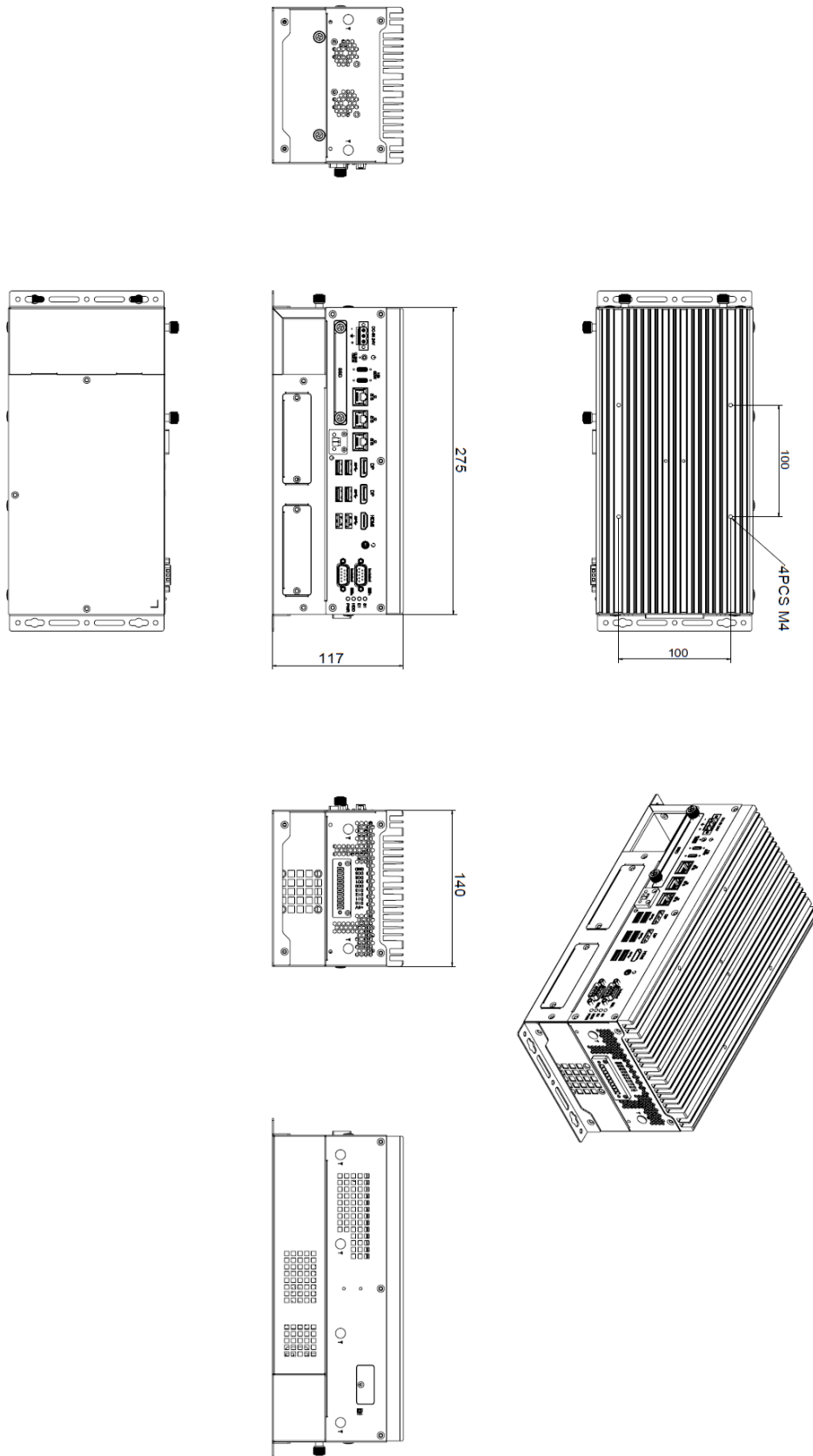

This page is intentionally left blank.

Chapter 2

Hardware Configuration

The information provided in this chapter includes:

- Installation
- Information and locations of connectors

2.1 Installation

Remove the SSD compartment to access the SSD storage device or as part of the steps to access the memory and other cards.

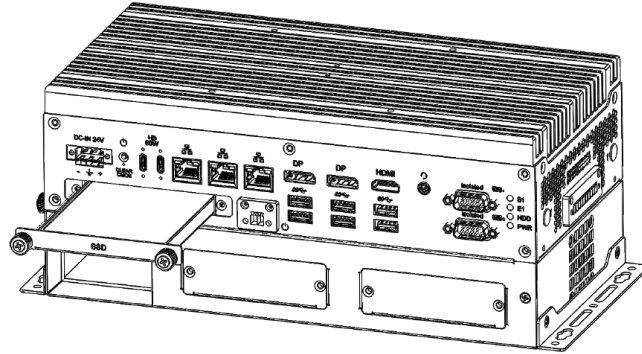

Remove the side mounting brackets by removing 4 screws as indicated below.

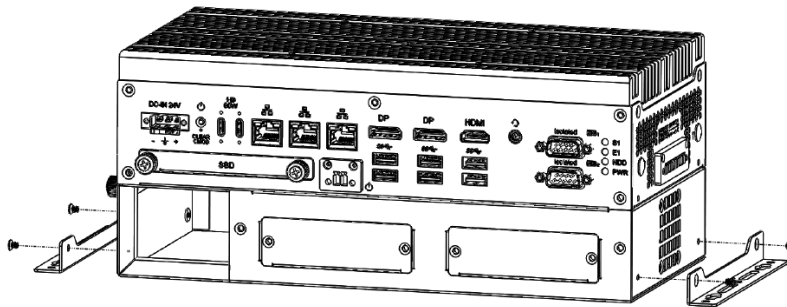

Remove the bottom cover by removing five screws as indicated below for the installation or replacement of the memory module, and accessory cards. Then proceed to remove the SSD compartment (if not removed) and the storage kit to expose the motherboard (shown in the next figure).

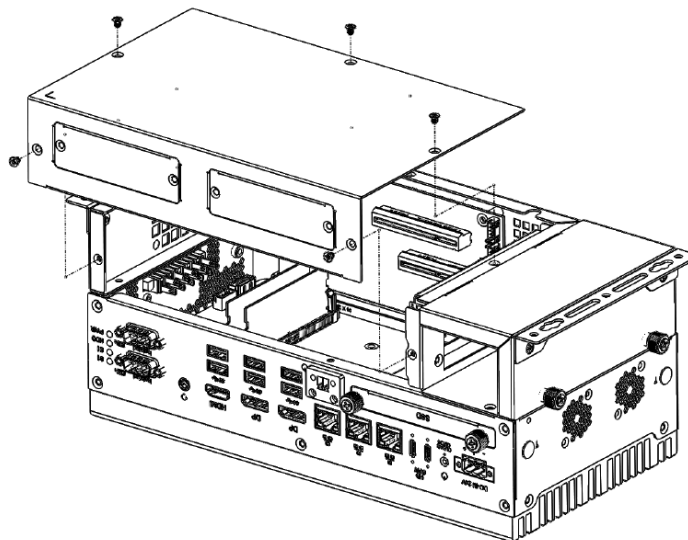

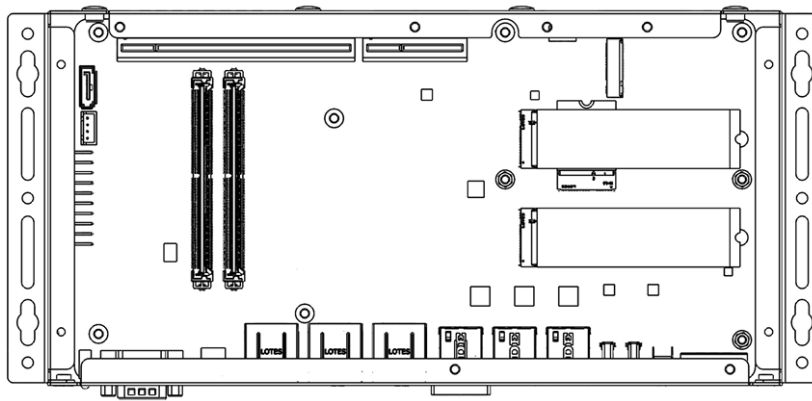

2.1.1 Memory Installation / Replacement

Now that the system memory slots (J7, J8) are accessible, locate the slots.



1. After removing the bottom cover, locate the memory slots.
2. Install DIMM 1 first, then install DIMM 2, to ensure proper installation clearance.

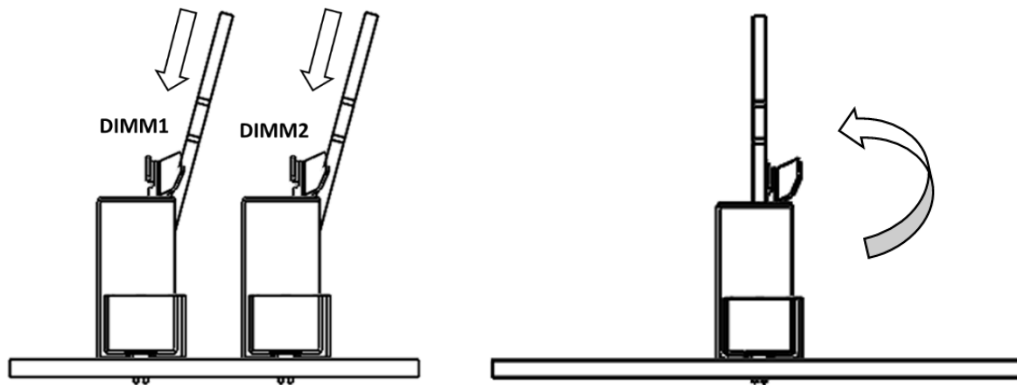

3. Hold the memory module and align the key of the module with that on the memory slot.
4. Gently push the module in an upright position until the ejector tabs of the memory slot close to hold the module in place until the module is fully seated.

To remove the module, press the ejector tabs outwards with your fingertips to eject the module.

2.1.2 M.2 Cards Installation / Replacement

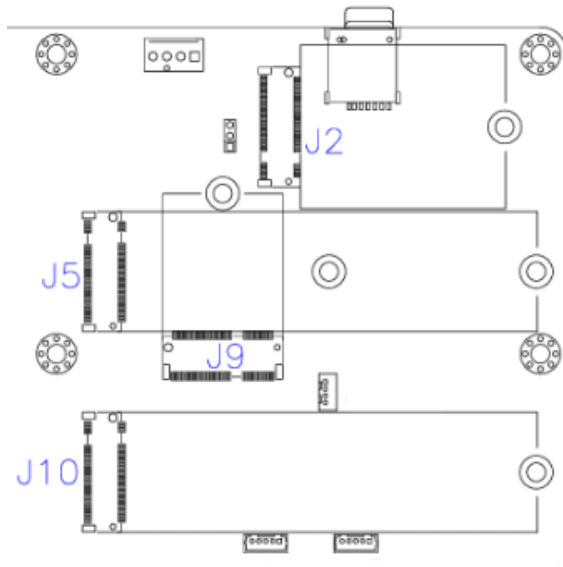

The M.2 card slots are located on the upper right of the motherboard as shown in the above figure. Align the notch of the M.2 card with the connector key and insert the card at an angle. Press the card downward and secure it using the supplied M.2 mounting screw.

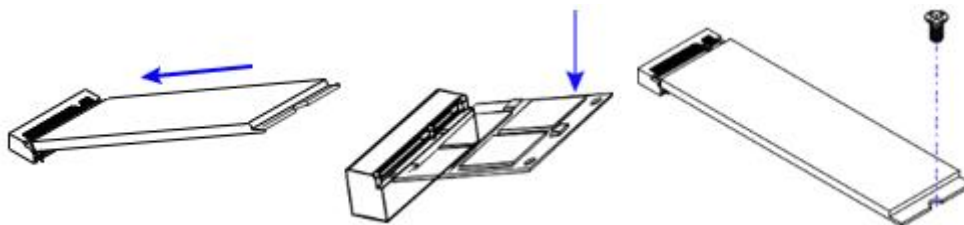

Function	Jumper
M.2 B-Key Connector	J2
M.2 M-Key Connector (Supports PCIe_X1 or SATA)	J5
M.2 E-Key [Supports USB2.0 & PCIe] (for Wi-Fi module)	J9
M.2 M-Key Connector	J10

2.1.3 Wi-Fi / 5G / 4G Antenna Installation

Thread the Wi-Fi / 5G / 4G antenna extension cable through an antenna hole of the front I/O cover and fasten the antenna as shown below. Apply adhesive to the hex nut behind the front I/O cover to prevent the antenna cable from loosening.

1. Thread and fasten the hex nut and the washer. Then install the antenna.

2. Apply adhesive around here.

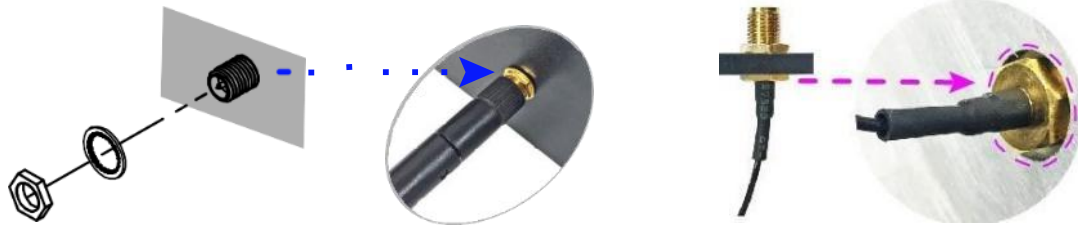

Info: The diameter of the nut is around 6.35 mm (0.25"-36UNC).

2.1.4 IP302 Expansion Card

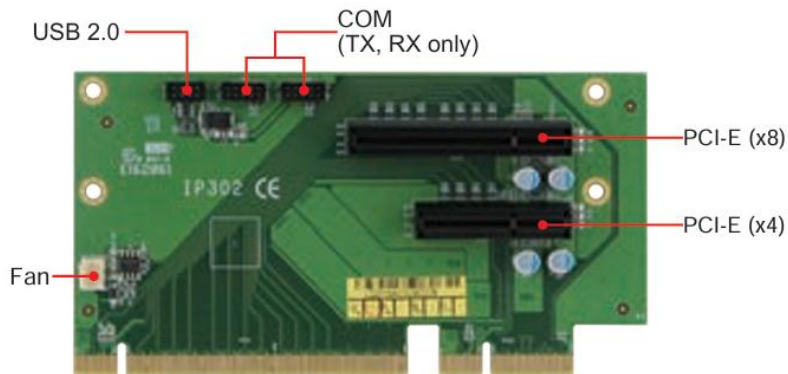

Remarks: The IP302 slots have PCIe(4x) signals only.

2.1.5 Mounting Installation

2.1.5.1. Wall-Mounting Installation

1. Prepare at least four (4) screws (M3) to install the device on a wall.



2.1.5.2. VESA Mounting Installation

1. Attach the 100x100mm VESA mounting bracket to your product, and secure with the supplied M4x4 screws.

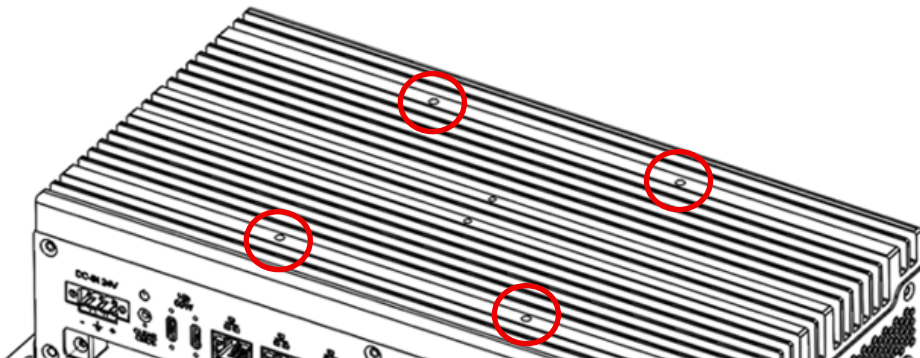

2.1.5.3. DIN Rail Mounting Installation

1. Attach the DIN rail mounting bracket to either the side or the top side of the unit and secure with the supplied screws.

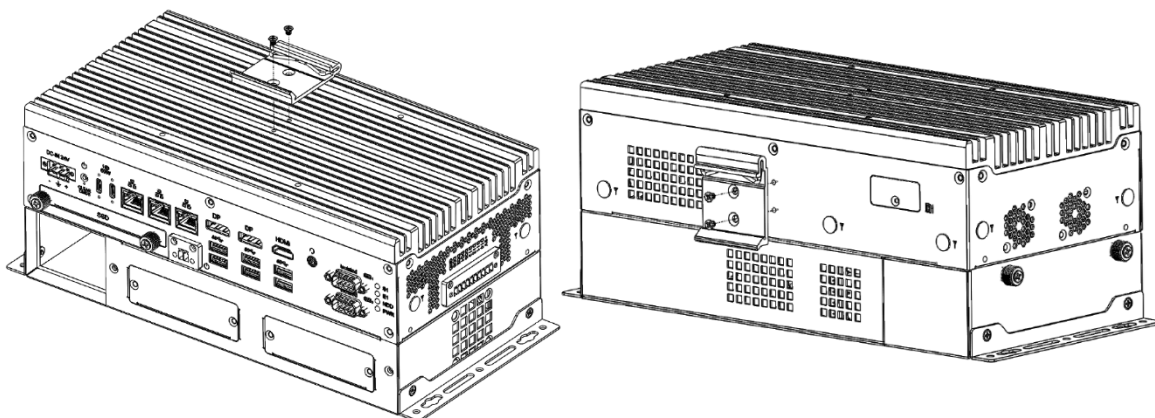

- Hook the DIN rail mounting bracket over the top of the DIN rail, and then press the lower section of the bracket towards the DIN rail to clip the bracket onto it.

2.1.6 Pinout for COM Ports, DC-In Power Connector & Line-Out Jack

2.1.6.1. COM1 / COM2 RS232/422/485 Ports

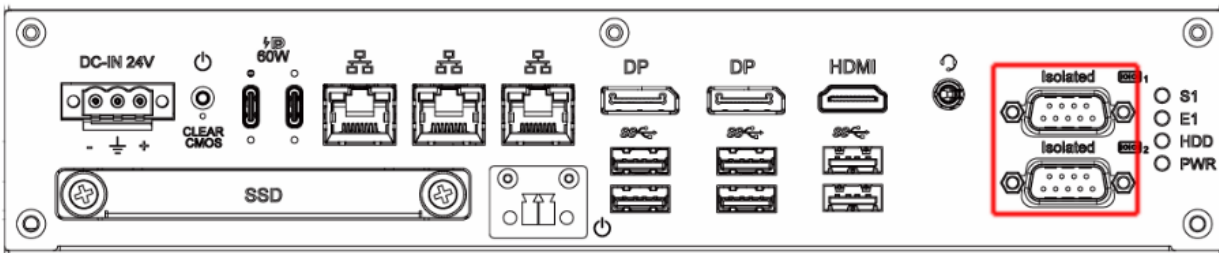

COM1 port is jumper-less and configurable in BIOS.

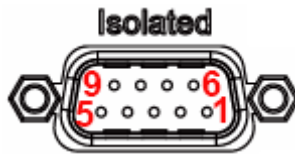

Pin	Assignment		
	RS-232	RS-422	RS-485
1	DCD, Data carrier detect	TX-	DATA-
2	RXD, Receive data	TX+	DATA+
3	TXD, Transmit data	RX+	NC
4	DTR, Data terminal ready	RX-	NC
5	Ground	Ground	Ground
6	DSR, Data set ready	NC	NC
7	RTS, Request to send	NC	NC
8	CTS, Clear to send	NC	NC
9	RI, Ring indicator	NC	NC

2.1.6.2. DC-In Power Connector (3-pin terminal block)

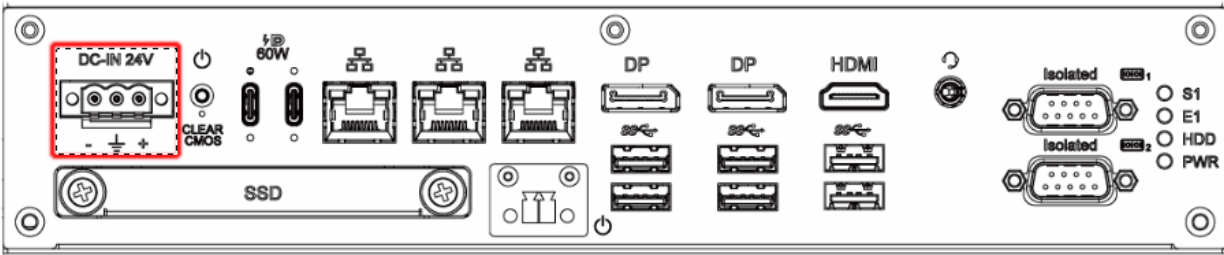

Pin	Assignment	Pin	Assignment
1	24V	2,3	Ground

2.1.6.3. 4-In & 4-Out GPIO Connector (10-pin terminal block)

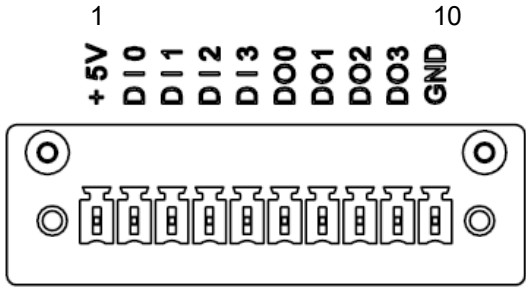

Pin	Assignment	Pin	Assignment
1	+5V	6	OUT0
2	IN0	7	OUT1
3	IN1	8	OUT2
4	IN2	9	OUT3
5	IN3	10	Ground

2.1.6.4. Audio Line-Out Jack

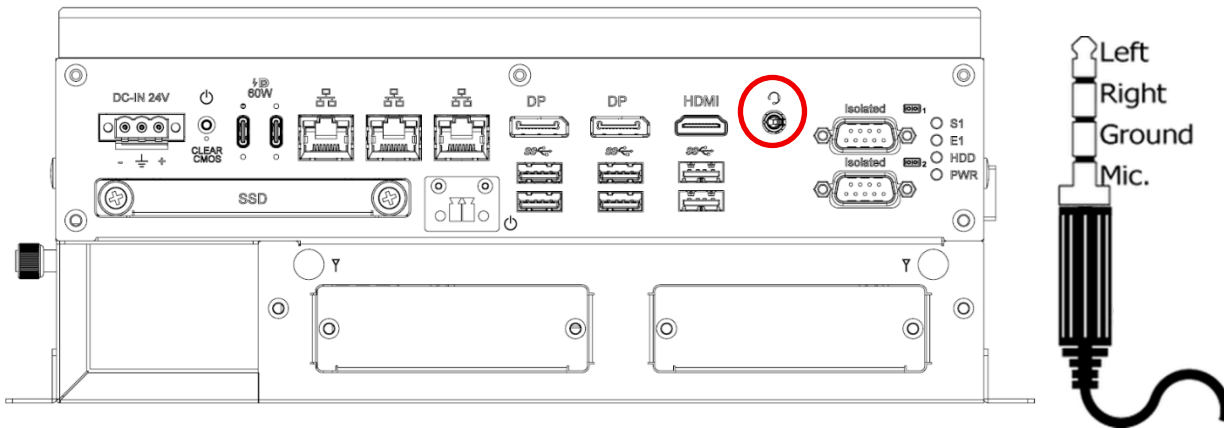

2.2 Setting the Jumpers

Use jumpers to configure your device's settings and features for specific applications. If you are unsure about the correct configuration, consult your supplier.

A jumper is a set of metal pins mounted on the circuit board, with a plastic cap used to connect two pins. Placing the jumper cap on specific pins enables or disables certain features. On a 3-pin jumper, you can short either pins 1–2 or pins 2–3 to select different settings.

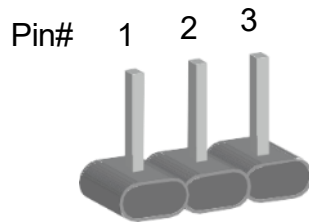

A 3-pin jumper

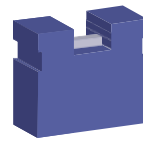

A jumper cap

Refer to the illustration below to set jumpers.

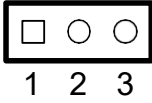
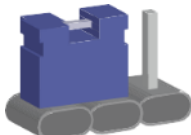
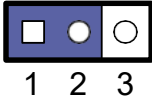
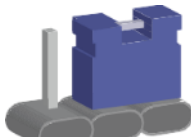
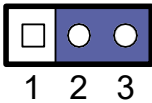
Pin closed	Oblique view	Illustration
Open		 1 2 3
1-2		 1 2 3
2-3		 1 2 3

When two pins of a jumper are encased in a jumper cap, this jumper is **closed** (on). When a jumper cap is removed from two jumper pins, this jumper is **open** (off).

2.3 MBE330 Motherboard

MBE330 Motherboard Dimensions

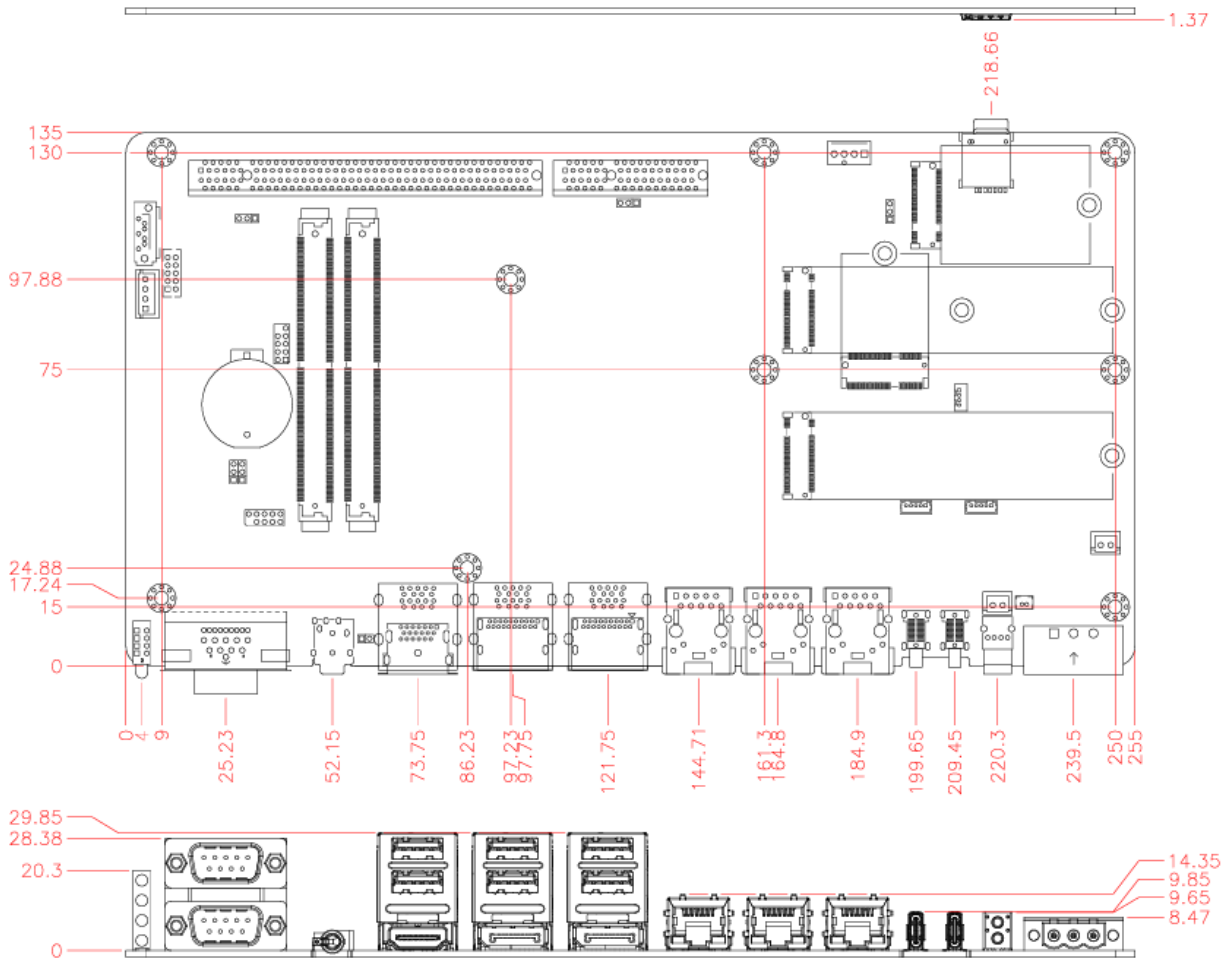

MBE330 Motherboard Connectors and Jumpers

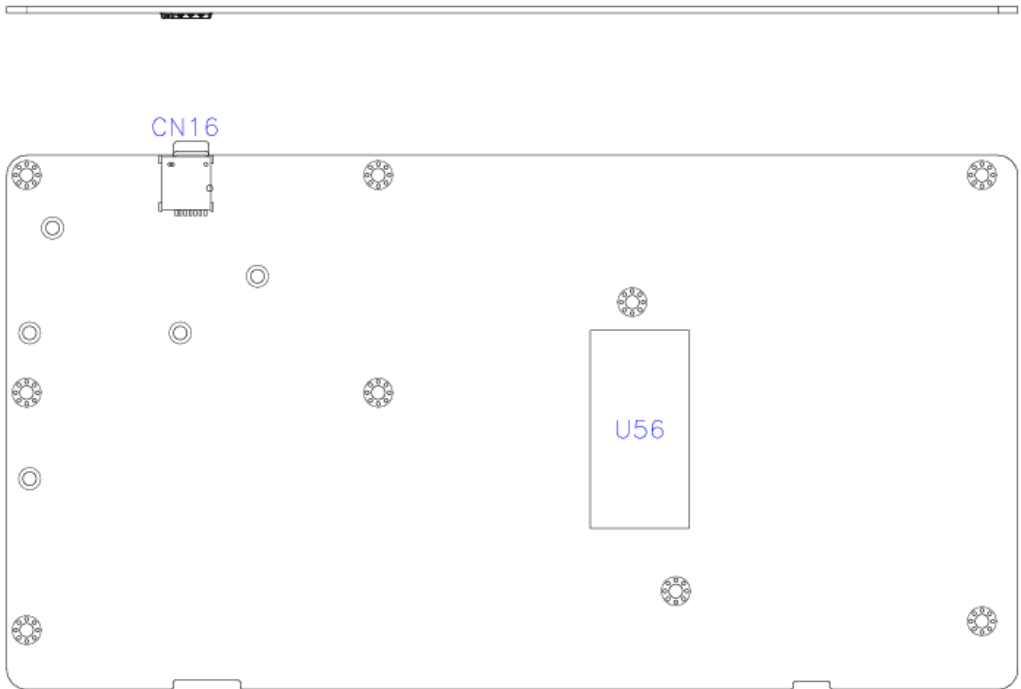
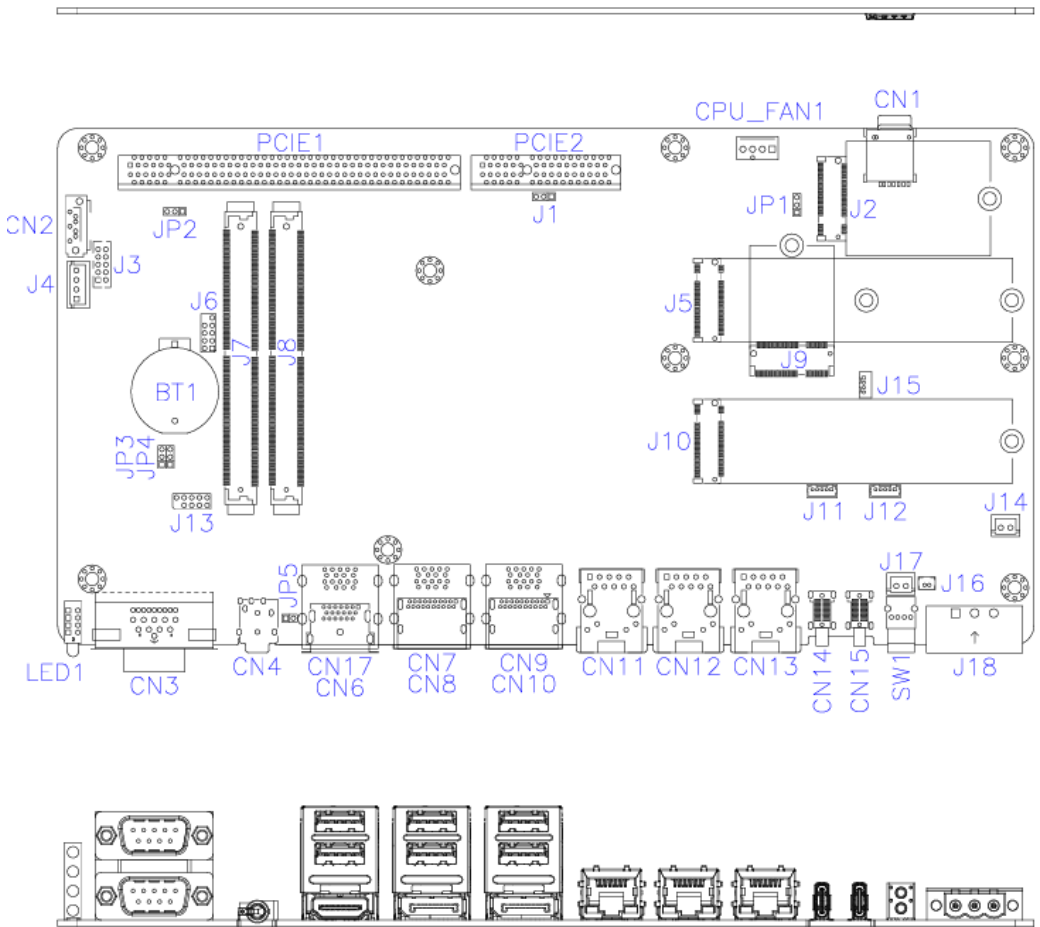

2.4 Jumpers Quick Reference

Function	Jumper
M.2 B-Key Support Type	JP1
AT/ATX Mode Selection	JP2
Clear ME	JP3
Clear RTC	JP4
Flash Descriptor Security Override	JP5

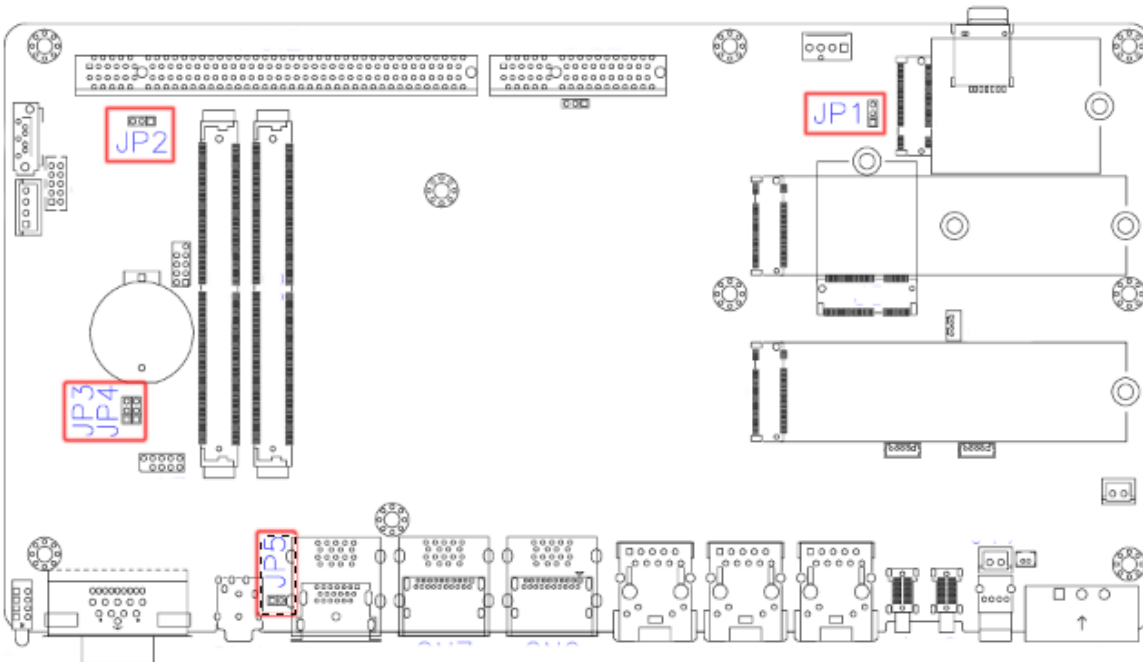

2.4.1 JP1: M.2 B-Key Support Type

Function	Pin closed	Setting
USB	1-2	<input type="checkbox"/> <input checked="" type="checkbox"/> <input type="checkbox"/> 1
PCIe	2-3	<input checked="" type="checkbox"/> <input type="checkbox"/> <input type="checkbox"/> 1

2.4.2 JP2: AT/ATX Mode Selection

Function	Pin closed	Setting
ATX	1-2	<input type="checkbox"/> <input checked="" type="checkbox"/> <input type="checkbox"/> 1
AT	2-3	<input checked="" type="checkbox"/> <input type="checkbox"/> <input type="checkbox"/> 1

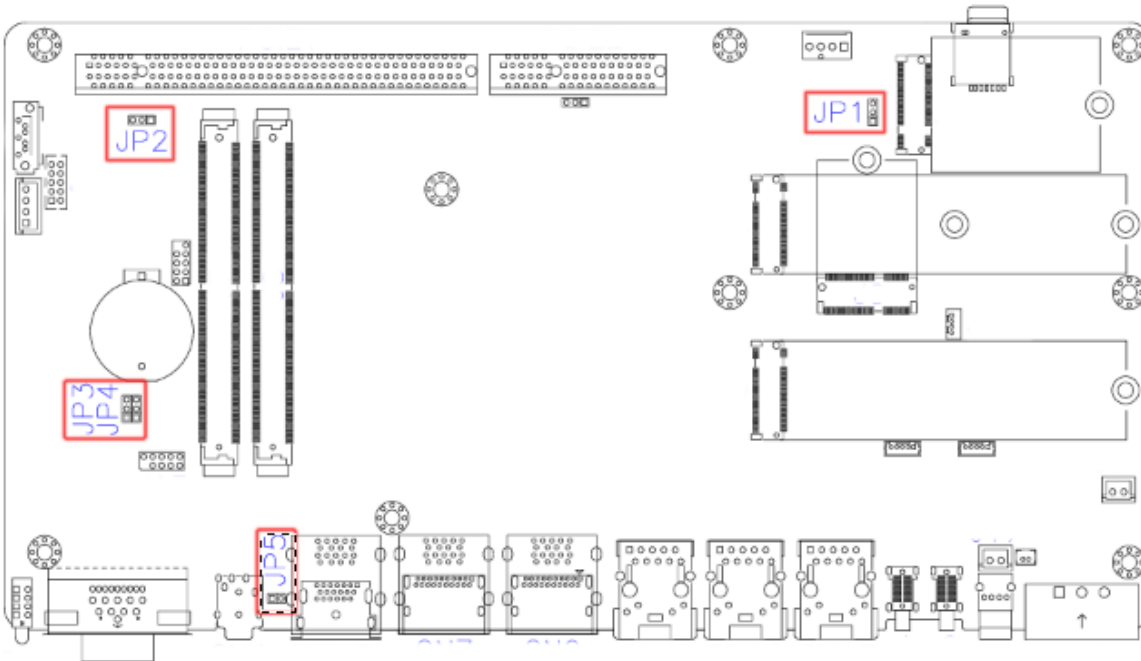

2.4.3 JP3: Clear ME

Function	Pin closed	Setting
Normal (Default)	1-2	<input type="radio"/> <input checked="" type="radio"/> <input type="checkbox"/> 1
Clear ME	2-3	<input checked="" type="radio"/> <input checked="" type="radio"/> <input type="checkbox"/> 1

2.4.4 JP4: Clear RTC

Function	Pin closed	Setting
Normal (Default)	1-2	<input type="radio"/> <input checked="" type="radio"/> <input type="checkbox"/> 1
Clear RTC	2-3	<input checked="" type="radio"/> <input checked="" type="radio"/> <input type="checkbox"/> 1

2.4.5 JP5: Flash Descriptor Security Override

Function	Pin closed	Setting
3.3V (default)	1-2	1 <input type="checkbox"/> <input checked="" type="radio"/> <input type="radio"/>
5V	2-3	1 <input type="checkbox"/> <input checked="" type="radio"/> <input checked="" type="radio"/>

2.5 Connectors Quick Reference

Function	Connector
SIM-1 Card Connector	CN1
SATA Connector	CN2
SIM-2 Card Connector	CN16
COM1 / 2 Connector	CN3
Audio Combo Connector	CN4
USB Stack 3.0 Connector	CN5
HDMI 2.0 Connector	CN6
USB 3.2 Connector	CN7
DisplayPort Connector	CN8, CN10
I226V LAN Jack	CN11, CN13
USB 3.2 Connector	CN9
I226LM LAN Connector	CN12
USB Type C Connector	CN14, CN15
Power Button / RTC_RST	SW1
M.2 B-Key Connector	J2
Digital IO Connector	J3
SATA Power Connector	J4
M.2 M-Key Connector (Support PCIe_X1 or SATA)	J5
SPI Debug Header	J6
SO-DIMM Socket	J7, J8
M.2 E-Key [Support USB2.0 & PCIe] (for Wi-Fi module)	J9
M.2 M-Key Connector	J10
PD JTAG	J11, J12
SPI Debug Header	J13
AT On/Off Switch	J14
USB 2.0 Pin Header	J15
Reset Header	J16
Remote PWR_BTN Header	J17
DC_IN Connector (3-pin terminal block)	J18
4 x LED indicators	LED1
PCI-Express (x16) Slot (used with IP305, IP302)	PCIE1
PCI-Express (x4) Slot (used with IP305, IP302)	PCIE2
For System Fan to PCIE_X4 Slot	SYS_FAN1
For CPU PWM Fan	CPU_FAN1

2.5.1 CN1: SIM-1 Card Connector

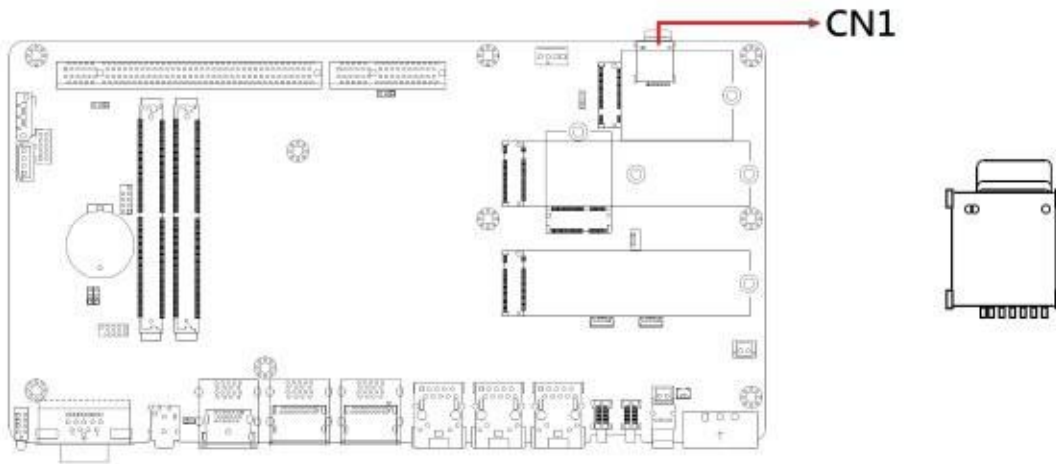

2.5.2 CN2: SATA Connector

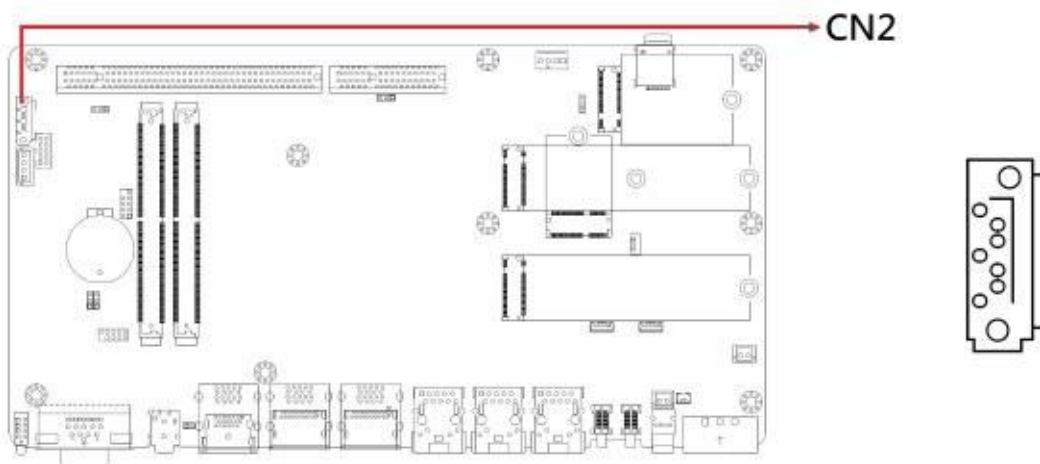

2.5.3 CN16: SIM-2 Card Connector

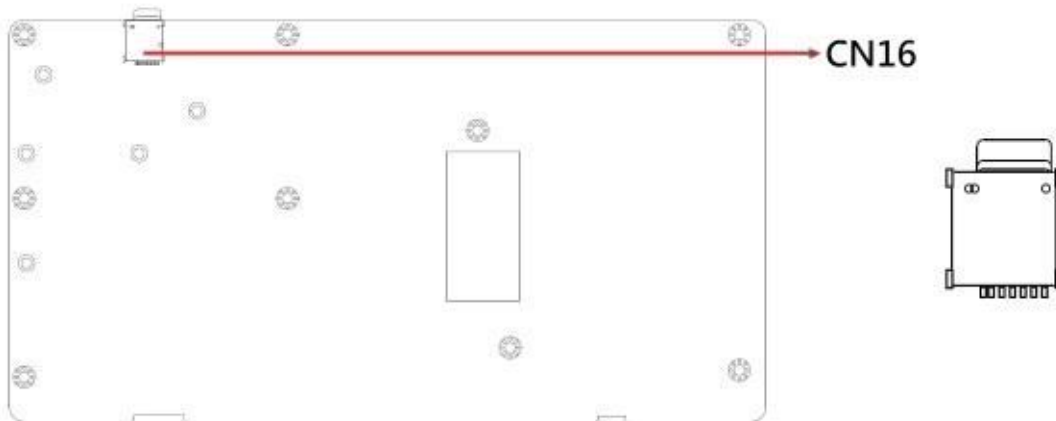

2.5.4 CN3: COM1 / 2 Connector

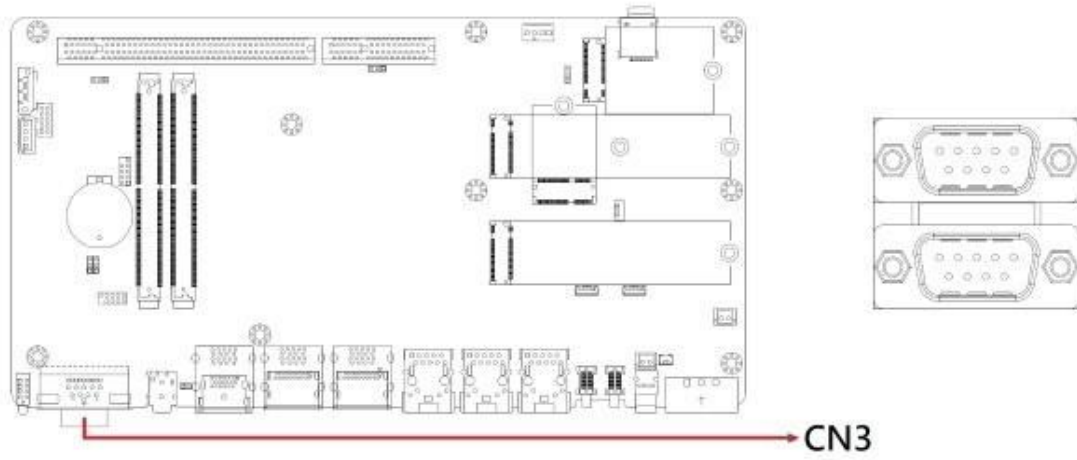

2.5.5 CN4: Audio Combo Connector

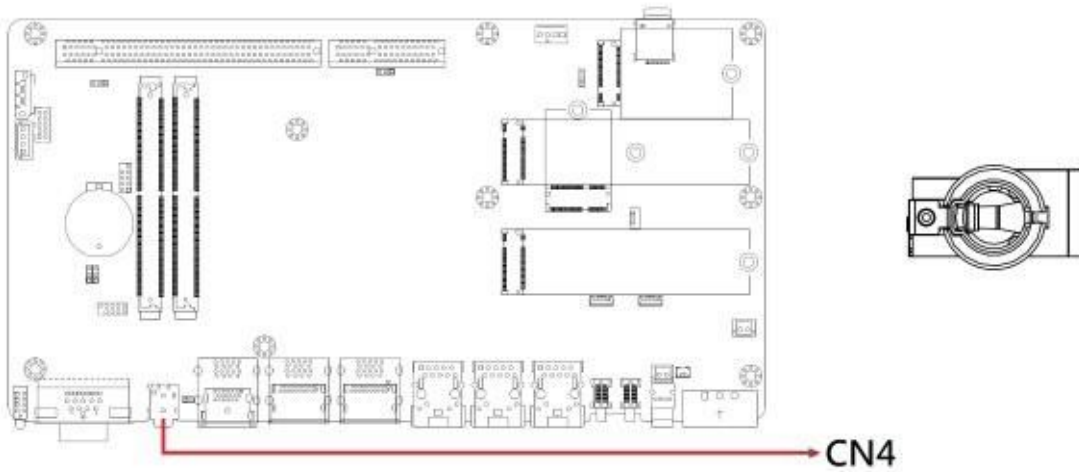

2.5.6 CN5: USB Stack 3.0 Connector

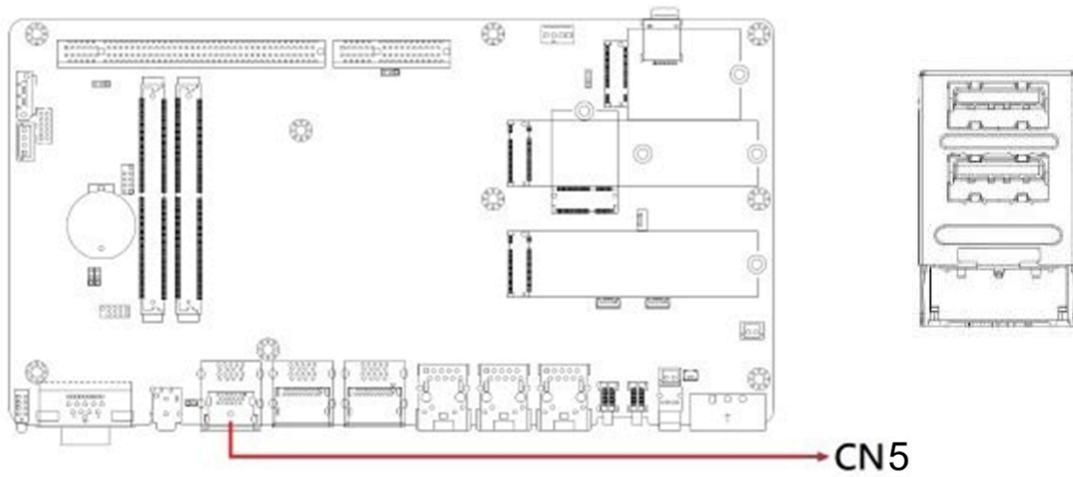

2.5.7 CN6: HDMI 2.0 Connector

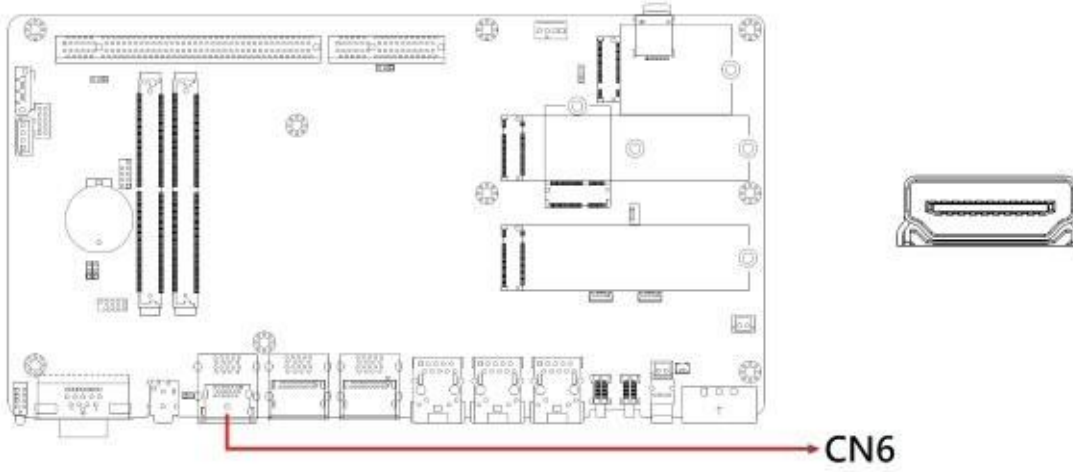

2.5.8 CN7: USB 3.2 Connector

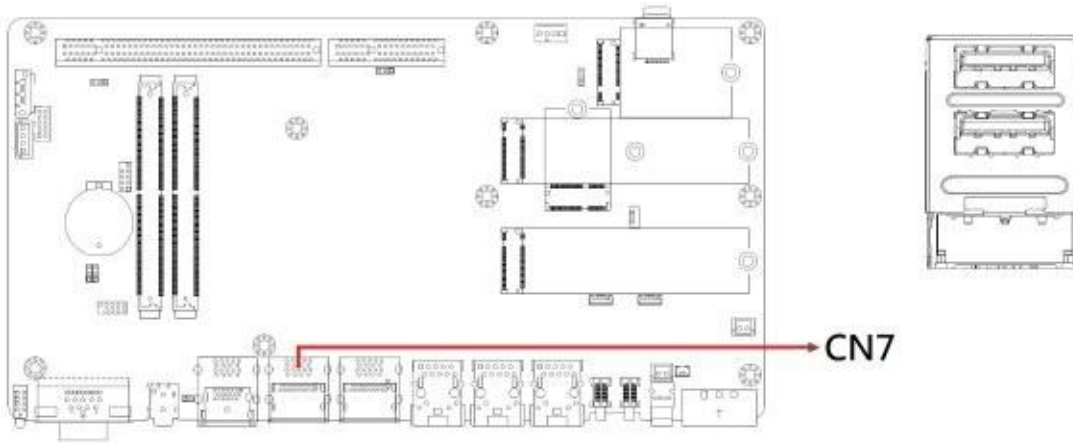

2.5.9 CN8, CN10: DisplayPort Connector

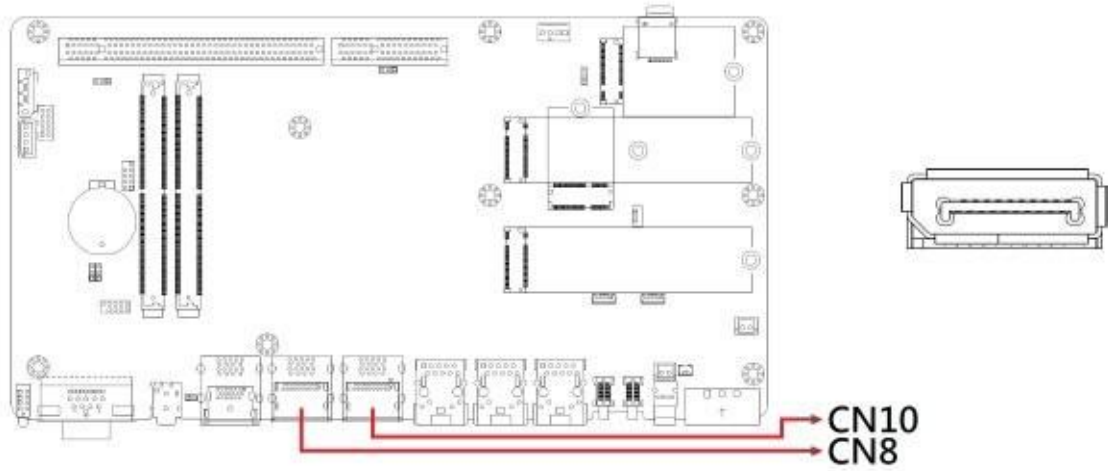

2.5.10 CN9: USB 3.2 Connector

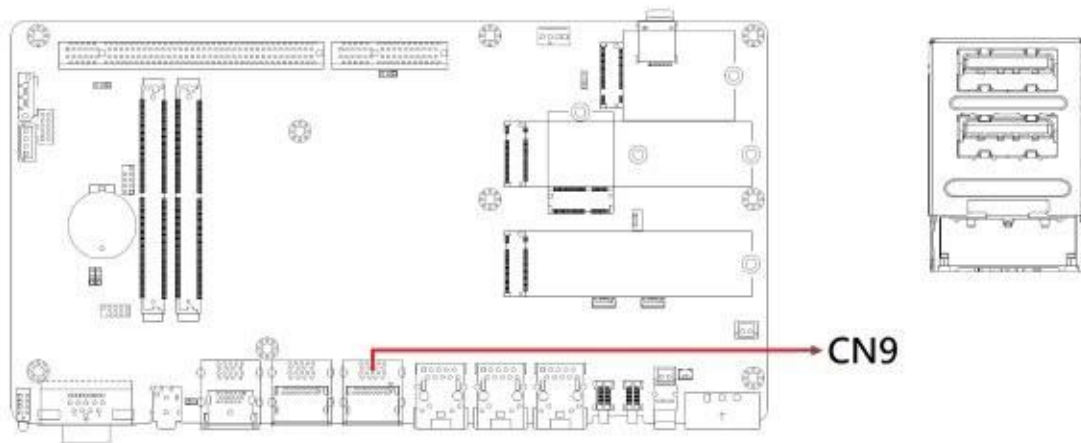

2.5.11 CN11, CN13: I226V LAN Jack

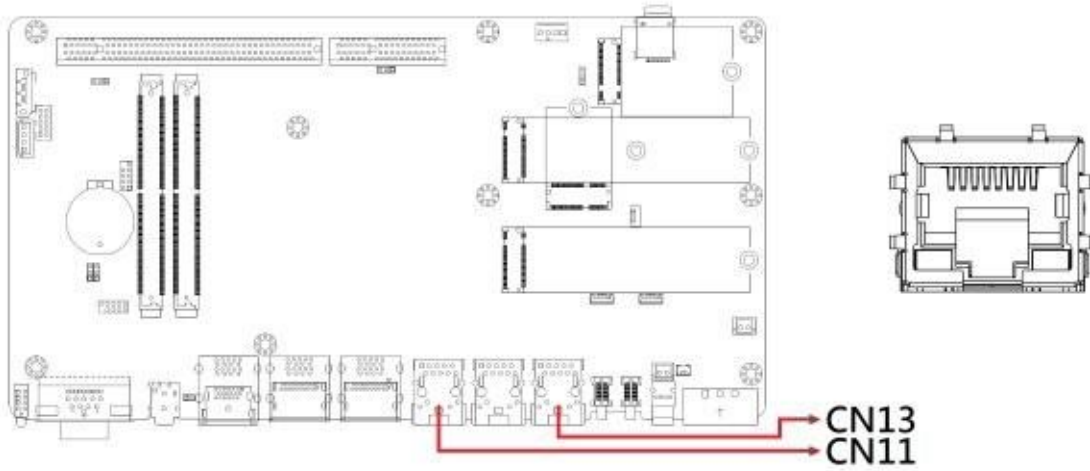

2.5.12 CN12: I226LM LAN Connector

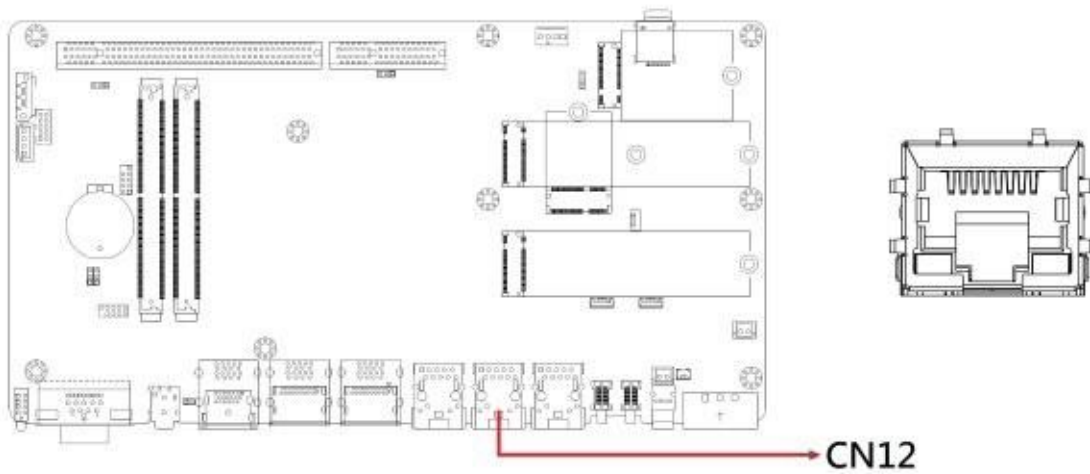

2.5.13 CN14, CN15: USB Type C Connector

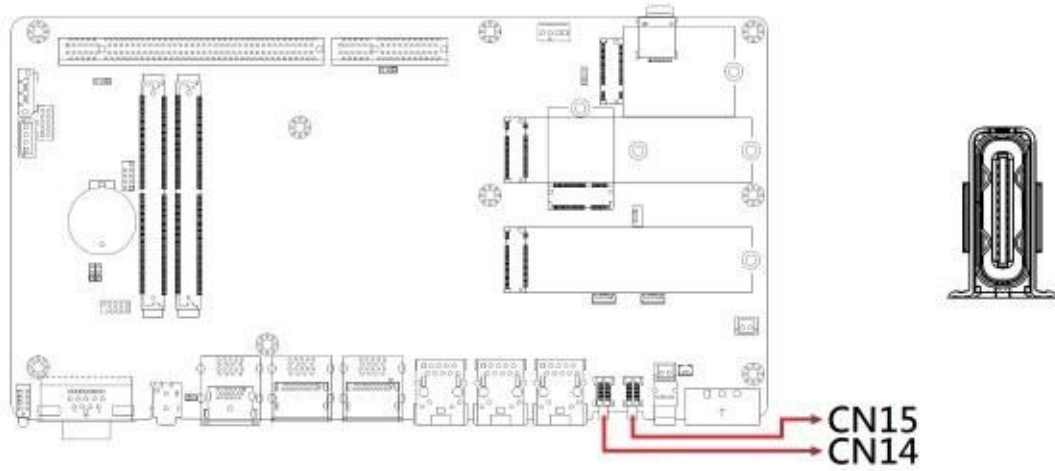

Note: Supports PD 60W each Port)

2.5.14 SW1: Power Button / RTC_RST

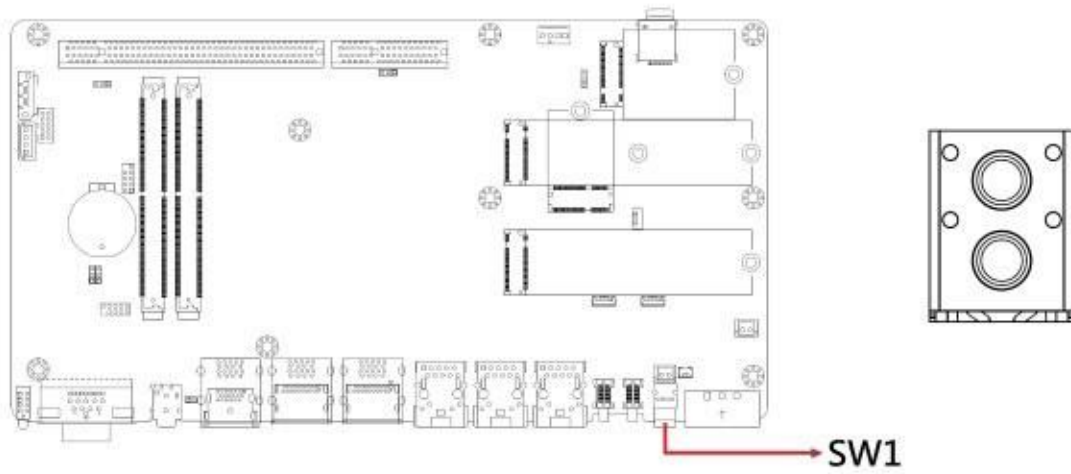

2.5.15 J2: M.2 B-Key Connector

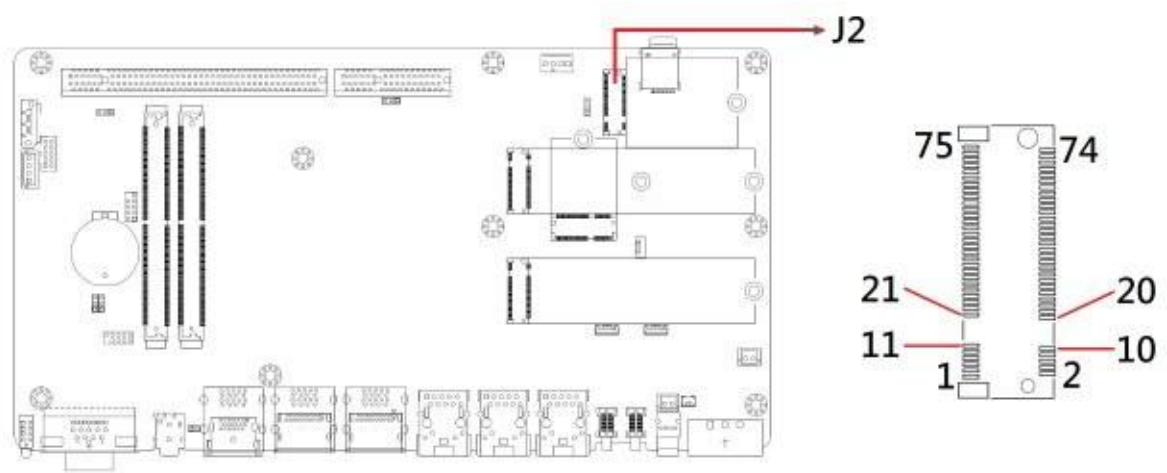

2.5.16 J3: Digital IO Connector

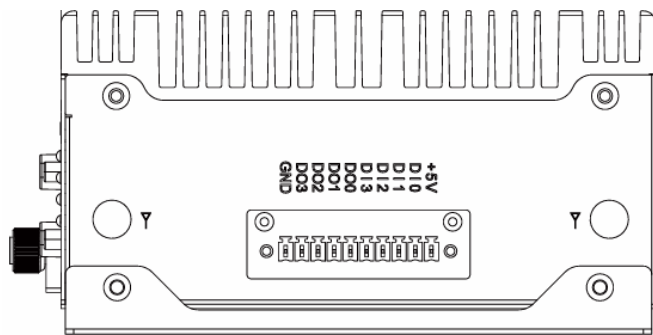

Pin	Assignment	Pin	Assignment
1	GND	2	VCC5
3	OUT3	4	OUT1
5	OUT2	6	OUT0
7	IN3	8	IN1
9	IN2	10	IN0

2.5.17 J4: SATA Power Connector

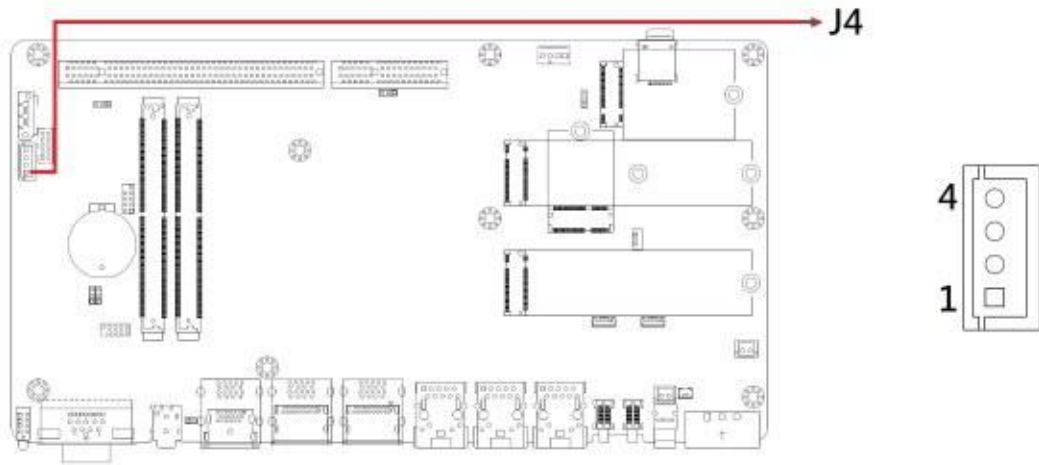

2.5.18 J5: M.2 M-Key Connector (Support PCIe_X1 / SATA)

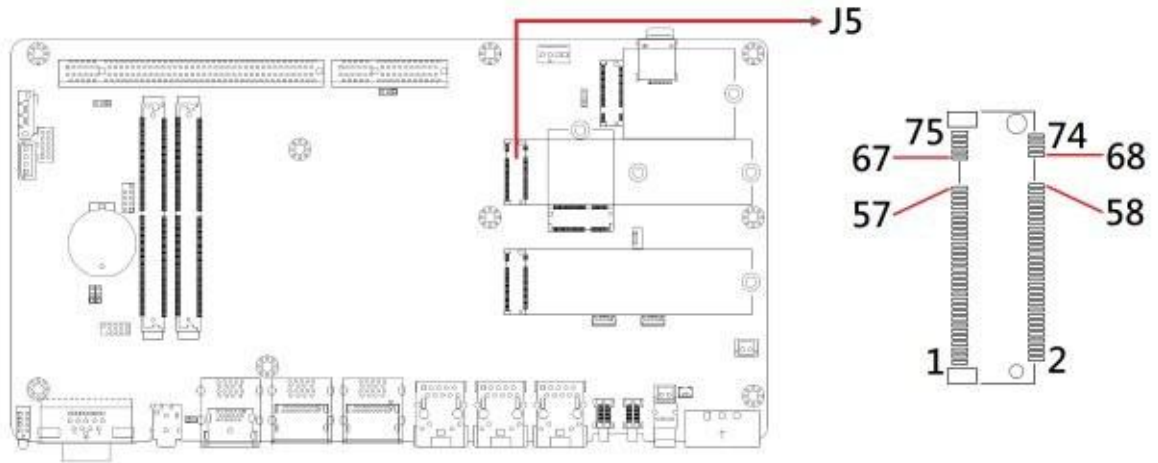

2.5.19 J6: SPI Debug Header

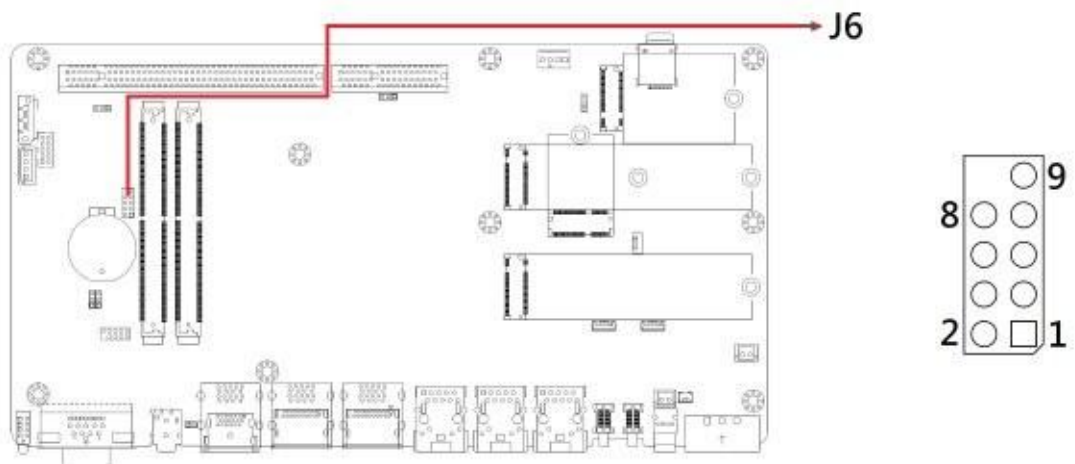

2.5.20 J7, J8: SO-DIMM Socket

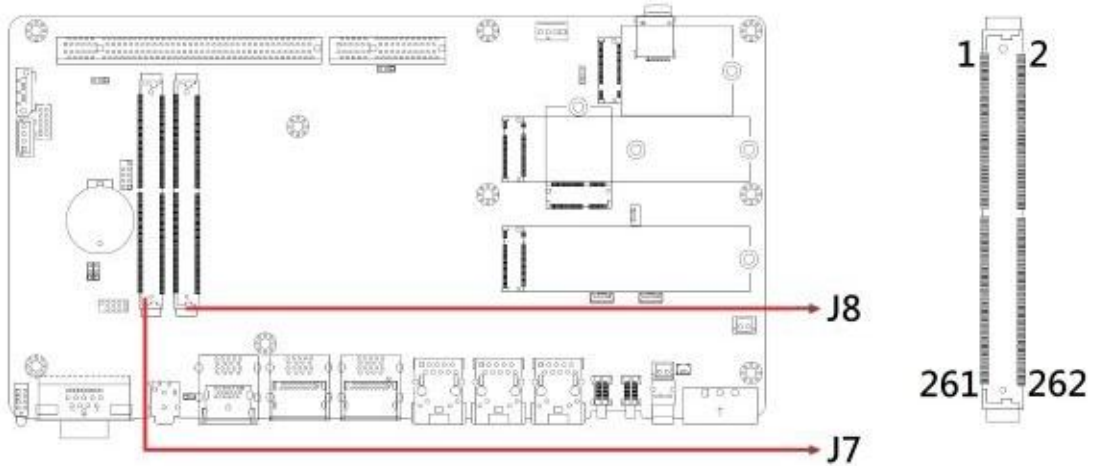

2.5.21 J9: M.2 E-Key [Support USB2.0 & PCIe] (for Wi-Fi module)

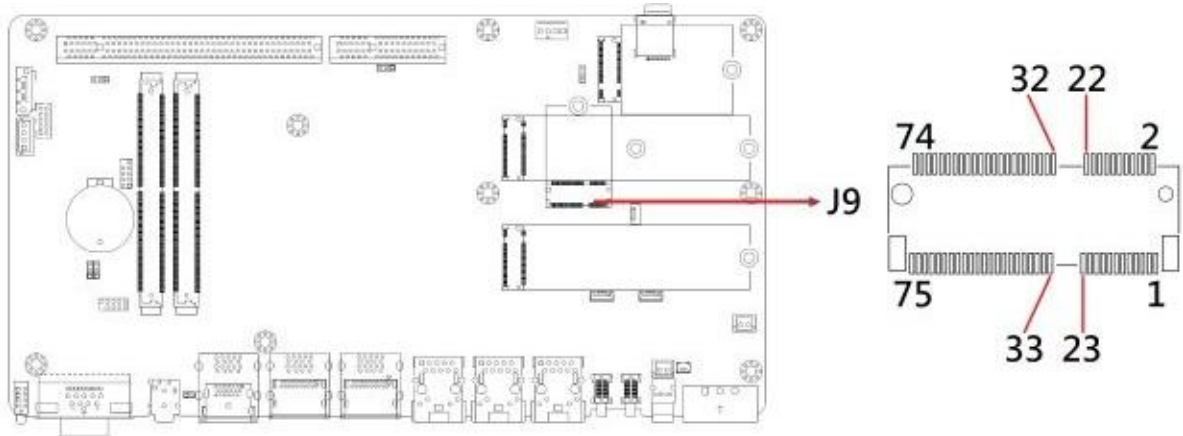

2.5.22 J10: M.2 M-Key Connector

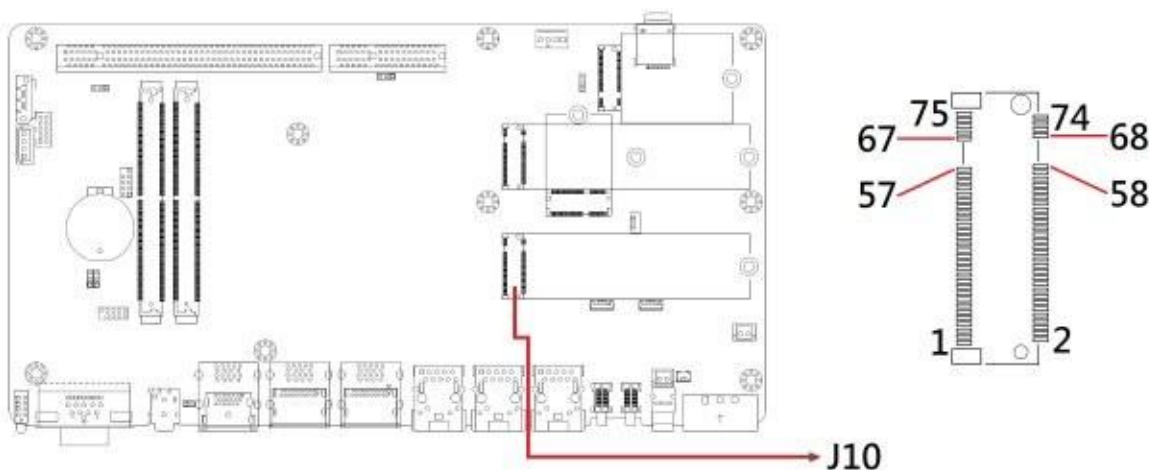

Note: Support PCIe_X1

2.5.23 J11, J12: PD JTAG

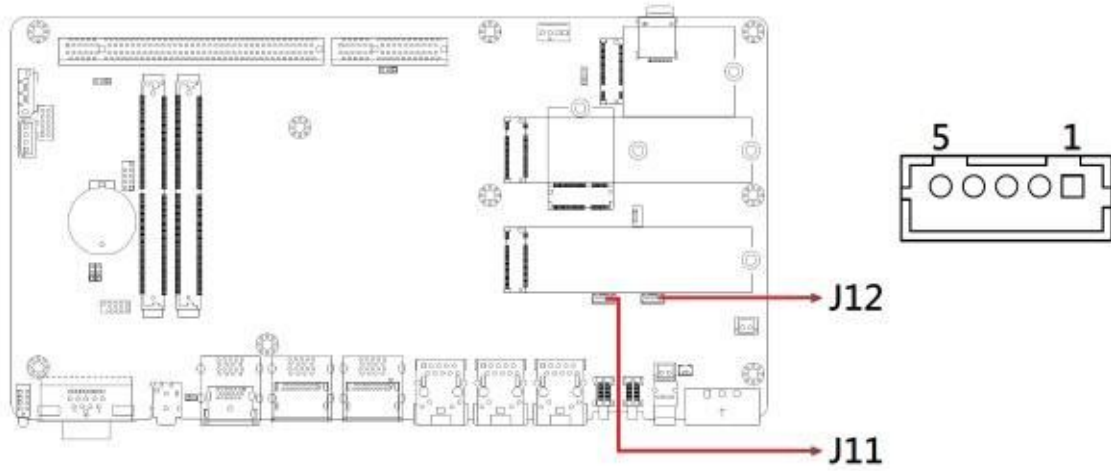

2.5.24 J13: SPI Debug Header

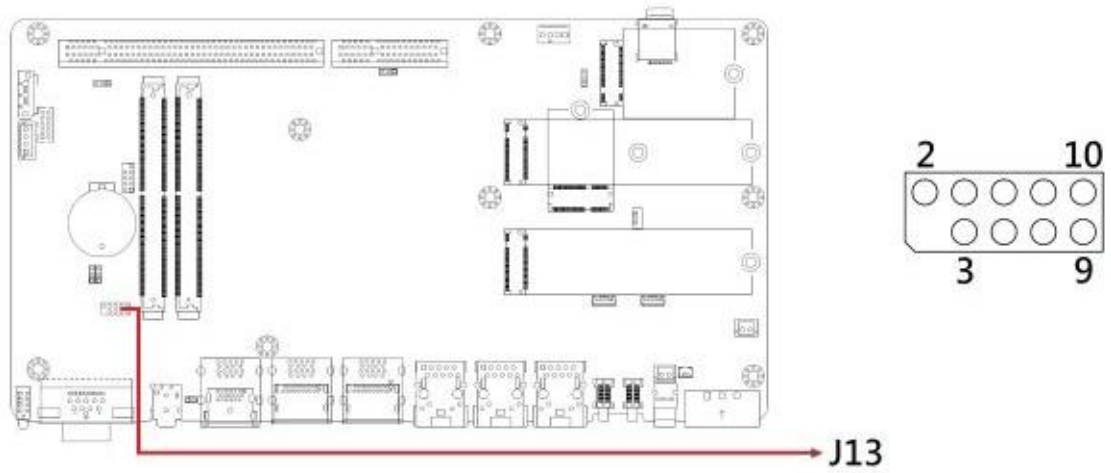

2.5.25 J14: AT On/Off Switch

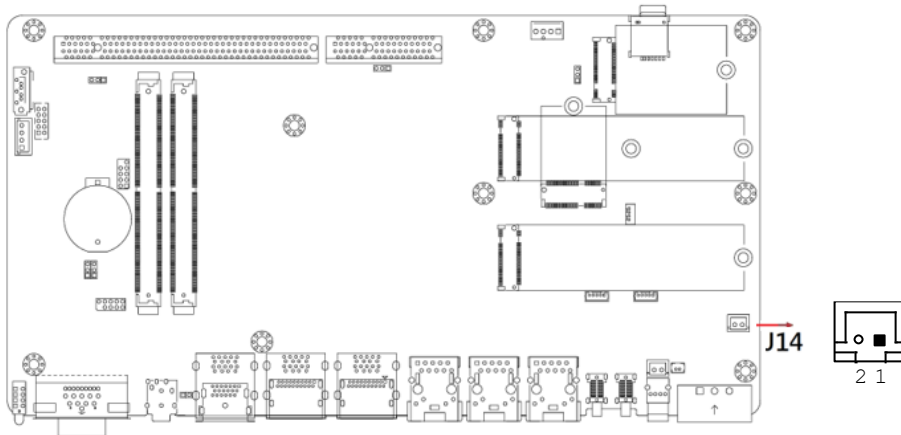

Pin	Assignment
1	SHDN#
2	GND

2.5.26 J15: USB 2.0 Pin Header

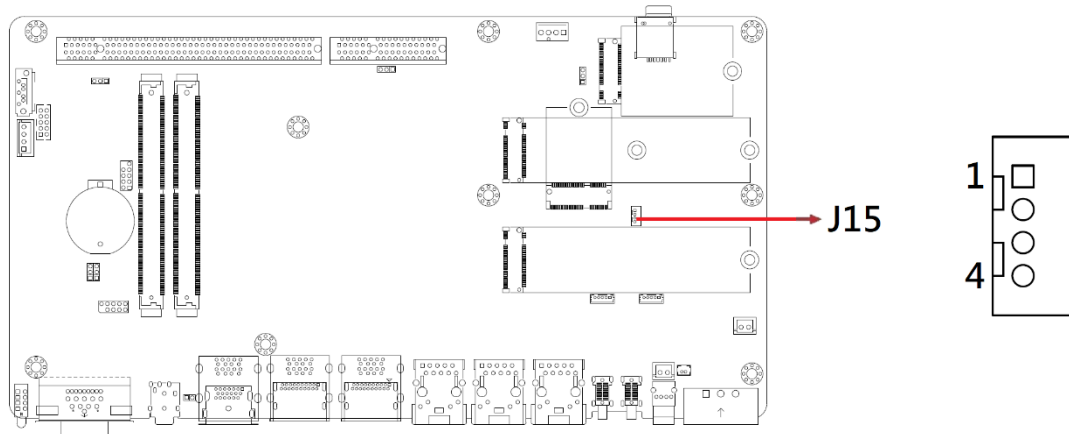

Pin	Assignment
1	VCC
2	USB-
3	USB+
4	GND

2.5.27 J16: Reset Header

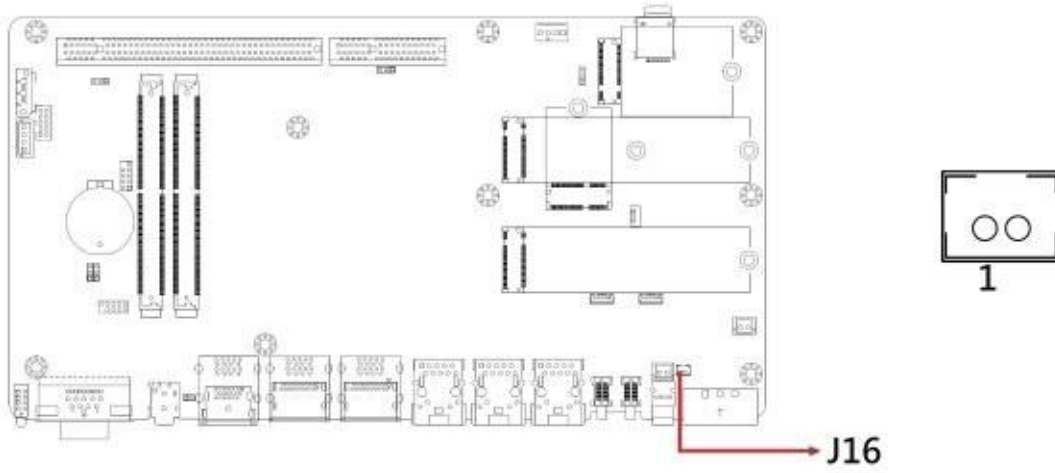

2.5.28 J17: Remote PWR_BTN Header

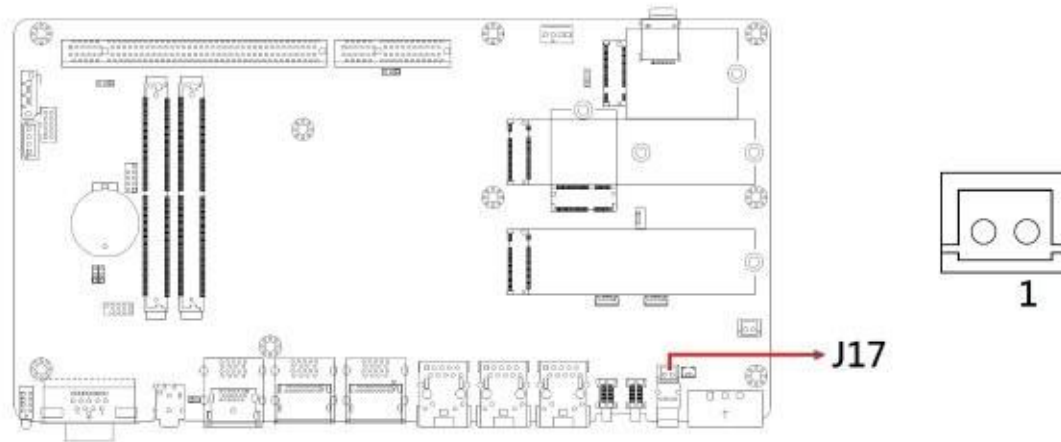

2.5.29 J18: DC_IN Connector (3-pin terminal block)

2.5.30 LED1: 4 x LED indicators

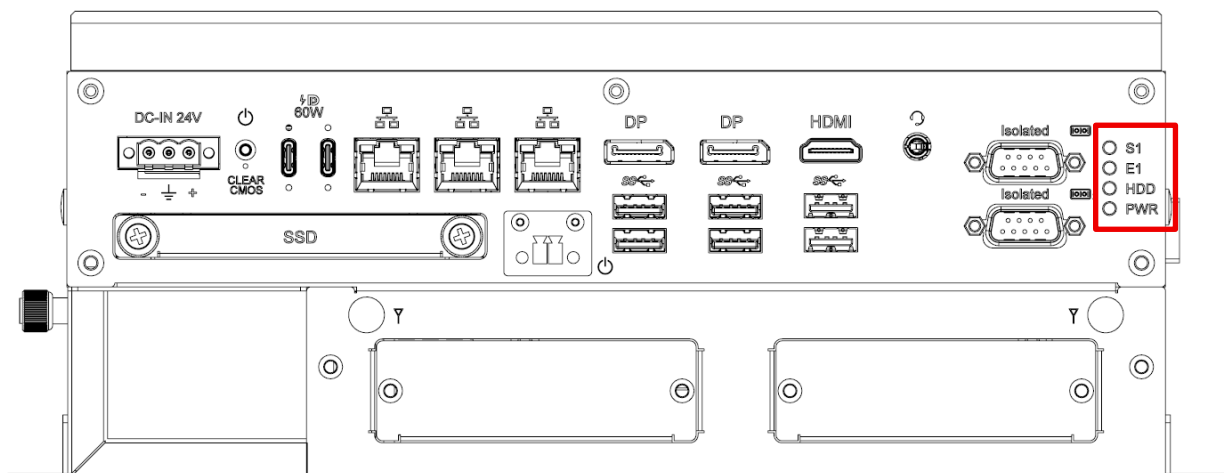

Note: For Power, HDD, RTC battery low, Programmable
Green (power LED)
Red (HDD)
Blue (RTC battery low)
Green/yellow (GPIO)

2.5.31 PCIe1: PCI-Express (x16) Slot (used with IP305, IP302)

Note: The signal supports PCIe_X4 (2 lanes)

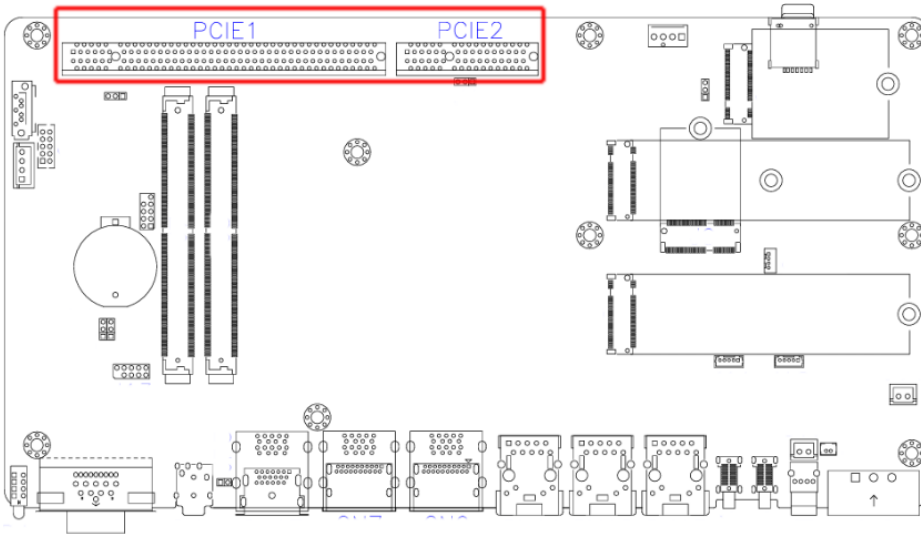

2.5.32 PCIe2: PCI-Express (x4) Slot (used with IP305, IP302)

Note: The signals include 1x PCI-E Clock and 2x USB 2.0 / 4x RS232(TX/RX)

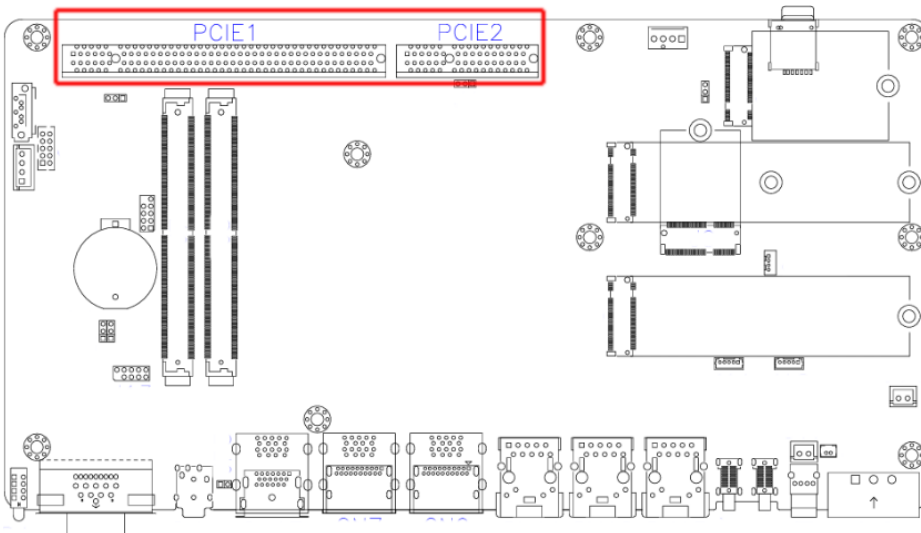

2.5.33 SYS_FAN1: For System Fan to PCIE_X4 Slot

2.5.34 CPU_FAN1: For CPU PWM Fan

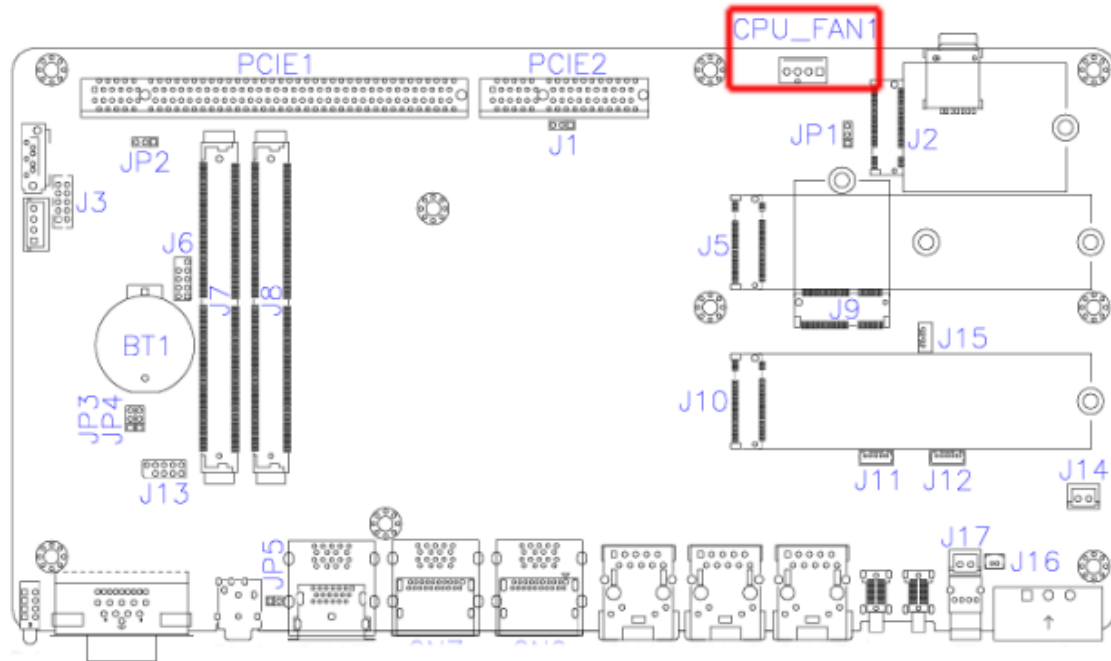

This page is intentionally left blank.

Chapter 3

Driver Installation

The information provided in this chapter includes:

- Intel® Chipset Software Installation Utility
- Graphics Driver Installation
- HD Audio Driver Installation
- Intel® ME Driver Installation
- LAN Driver Installation

3.1 Introduction

This section describes the installation of system drivers.

Download the latest drivers from the IBASE product support page.

Extract the driver package and run CDGuide to open the driver menu.

Note: After installing your Windows operating system, you must install the Intel® Chipset Software Installation Utility first before proceeding with the driver installation.

3.2 Intel® Chipset Software Installation Utility

The Intel® Chipset drivers should be installed first before the software drivers to install INF files for Plug & Play function for Intel chipset components. Follow the instructions below to complete the installation.

1. Click **Intel** on the left pane and then **Intel(R) RaptorLake-P/PS/U Chipset Drivers** on the right pane.



2. Click **Intel(R) Chipset Software Installation Utility**.



3. When the *Welcome* screen to the Intel® Chipset Device Software appears, click **Next** to continue.
4. Accept the software license agreement.
5. On the *Readme File Information* screen, click **Install**.

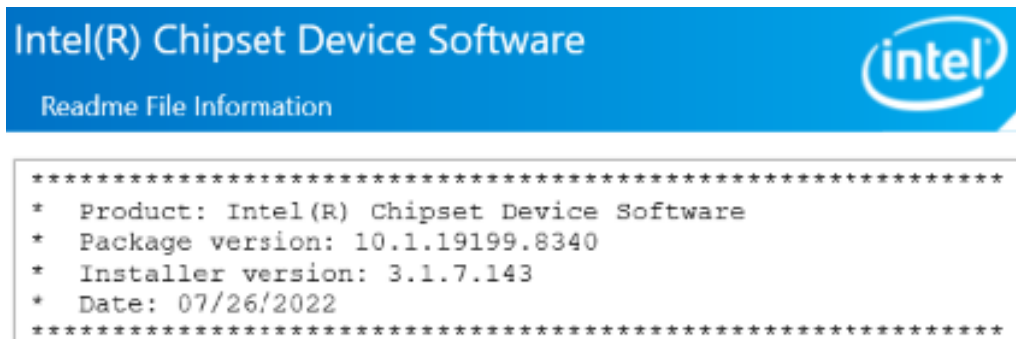

6. After completing the installation, click **Finish** to complete the setup process.

iBASE

3.3 VGA Driver Installation

1. Click **Intel** on the left pane and then **Intel(R) RaptorLake-P/PS/U Chipset Drivers** on the right pane.



2. Click **Intel(R) HD Graphics Driver**.



3. Click **Begin installation**.



4. Click **I agree** in the INTEL SOFTWARE LICENSE AGREEMENT screen.
5. Click **Start** to install the graphics driver.



6. When installation has been completed, click **Finish**.

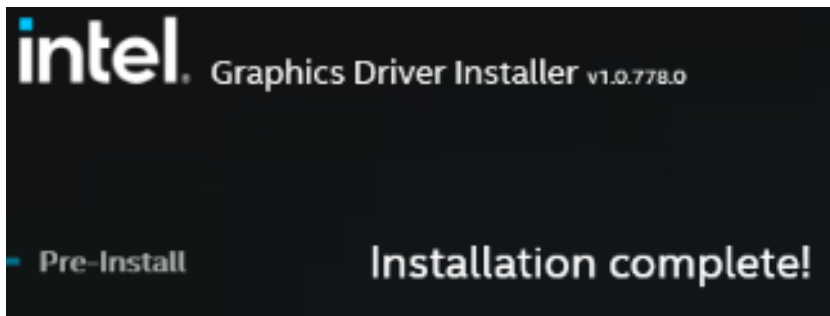

3.4 HD Audio Driver Installation

1. Before installing the Realtek audio drivers, run the batch file - **Intel_Sound.bat** in the directory shown in the picture below:

I-13_Gen-P_U-1.0\Intel\AlderLake-P\Sound\Windows 10_11

Right-click on **Intel_Sound.bat** and **run the batch file as Administrator**.

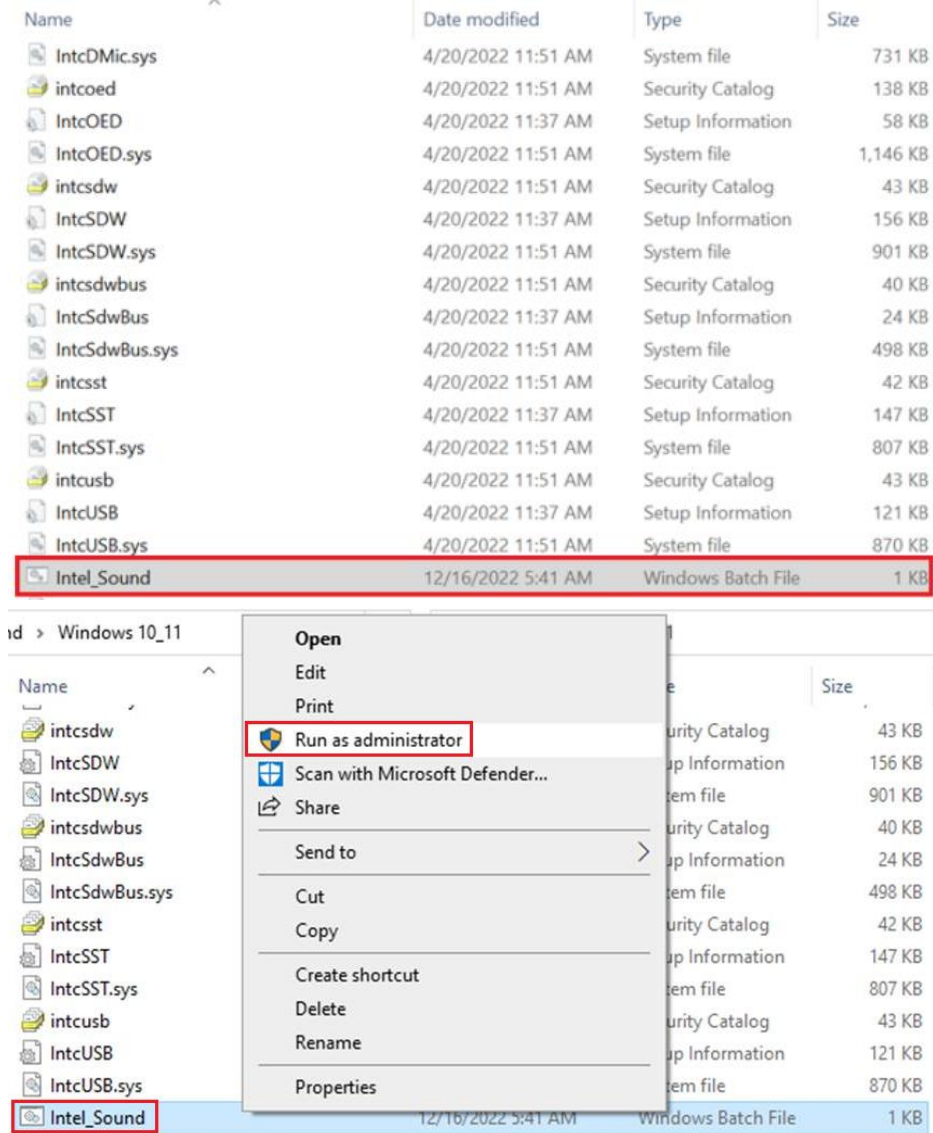

2. After running the batch file, proceed to the driver files, and install the audio drivers. Click **Intel** on the left pane and then **Intel(R) RaptorLake-P/PS/U Chipset Drivers** on the right.



3. Click **Realtek High Definition Audio Drivers**.



4. On the *Welcome* screen of the InstallShield Wizard, click **Next**.

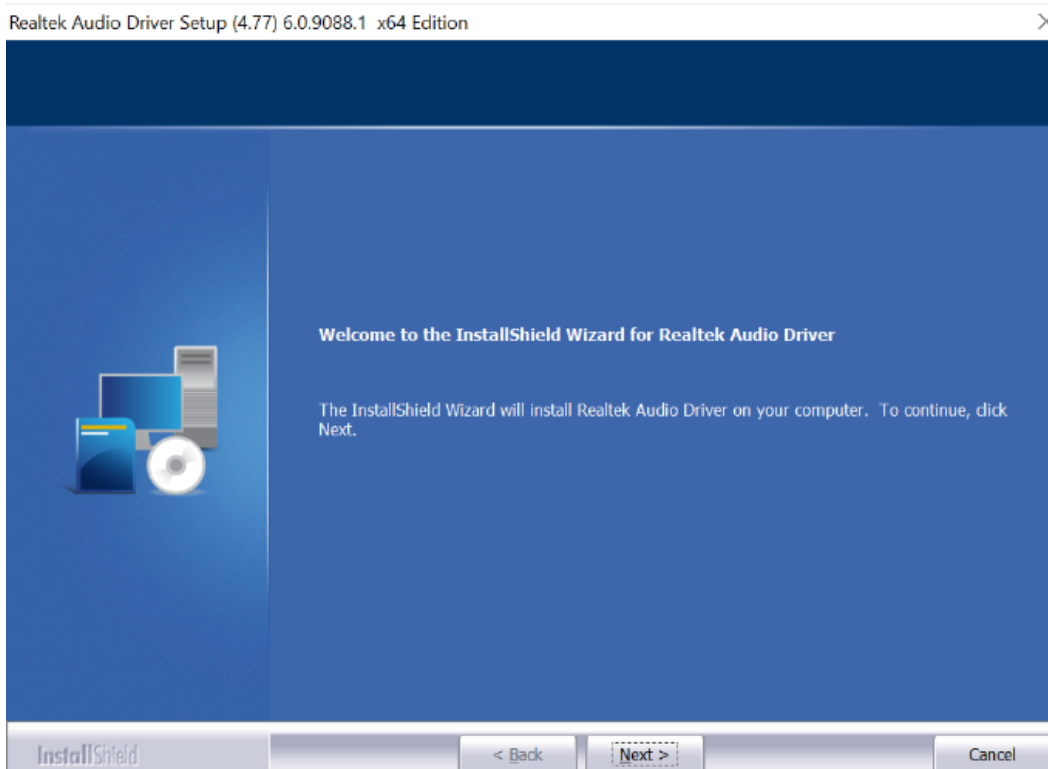

5. Click **Next** to continue the driver installation process.
6. After completing the installation, click **Finish** to restart the computer.

iBASE

3.5 LAN Driver Installation

1. Click **Intel** on the left pane and then **Intel(R) RaptorLake-P/PS/U Chipset Drivers** on the right pane.



2. Click **Intel(R) PRO LAN Network Drivers**.



3. On the *Network Connections* screen, click **Install Drivers and Software**.

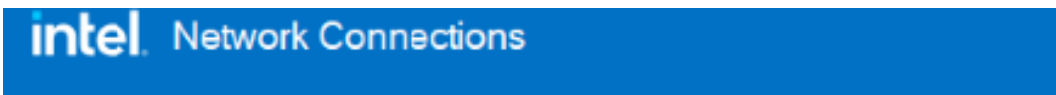

Install Drivers and Software

View User Guides

View Release Notes

[Networking at Intel.com](http://Networking.at.Intel.com)

Version: 27.4.0.1

4. When the Welcome to the install wizard for Intel(R) Network Connections screen appears, click **Next**.
5. On the next screen, accept the license agreement and click **Next**.
6. On the *Setup Options* screen, click the checkbox to select the desired driver(s) for installation. Then click **Next** to continue.

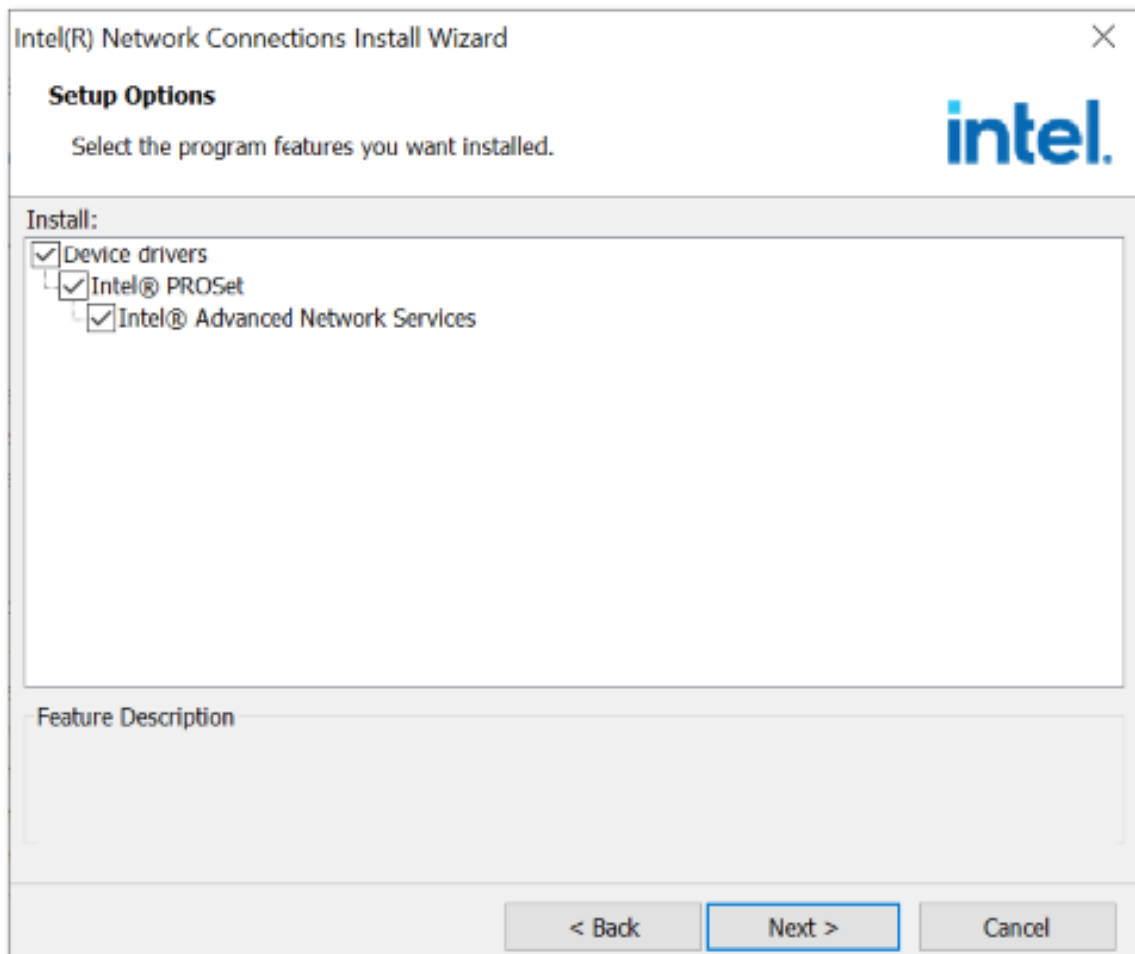

7. On the *Ready to Install the Program* screen, click **Install** to begin the installation. When the Install wizard has completed the installation, click **Finish**.

iBASE

3.6 Intel® Management Engine Components Driver Installation

1. Click **Intel** on the left pane and then **Intel(R) RaptorLake-P/PS/U Chipset Drivers** on the right pane.



2. Click **Intel(R) ME Drivers**.



3. When the Welcome screen appears, click **Next**.
4. Accept the license agreement and click **Next**.
5. After Intel Management Engine Components have been successfully installed, click **Finish**.

Chapter 4

BIOS Setup

This chapter describes the different settings available in the AMI BIOS that comes with the board. The topics covered in this chapter are as follows:

- Main Settings
- Advanced Settings
- Chipset Settings
- Security Settings
- Boot Settings
- Save & Exit

4.1 Introduction

The BIOS (Basic Input/Output System) installed in the ROM of your computer provides critical low-level support for standard devices such as disk drives and serial ports. It also provides password protection as well as special support for detailed fine-tuning of the chipset controlling the entire system.

4.2 BIOS Setup

The BIOS provides a Setup utility program for specifying the system configuration. The BIOS ROM of the system stores the Setup utility. When you turn on the computer, the BIOS is immediately activated. Press to enter the Setup utility. If you press the key too late, POST (Power On Self Test) will continue with its test routines, thus preventing you from invoking the Setup.

If you still need to enter Setup, restart the system by pressing the "Reset" button or simultaneously pressing the <Ctrl>, <Alt> and <Delete> keys. You can also restart by turning the system Off and back On again.

The following message will appear on the screen:

```
Press <DEL> to Enter Setup
```

In general, press the arrow keys to highlight items, <Enter> to select, the <PgUp> and <PgDn> keys to change entries, <F1> for help, and <Esc> to quit.

When you enter the BIOS Setup utility, the *Main Menu* screen will appear on the screen. The Main Menu allows you to select from various setup functions and exit choices.

Warning: It is strongly recommended that you avoid making any changes to the chipset defaults.

These defaults have been carefully chosen by both AMI and your system manufacturer to provide the absolute maximum performance and reliability. Changing the defaults could make the system unstable and crash in some cases.

4.3 Main Settings



BIOS Setting	Description
System Date	Sets the date. Use the <Tab> key to switch between the date elements.
System Time	Set the time. Use the <Tab> key to switch between the time elements.

iBASE

4.4 Advanced Settings

This section allows you to configure and optimize your system and set up some system features according to your preference.



4.4.1 Connectivity Configuration



BIOS Setting	Description
CNVi Mode	This option configures Connectivity. Auto Detection – means that if Discrete solution is discovered it will be enabled by default. Otherwise Integrated solution (CNVi) will be enabled; Disable Integrated – disables Integrated Solution.
BT Audio Offload	This is an option to enable input from BT device to the audio DSP and enables power efficient audio output to BT device.
RFI Mitigation	This is an option intended to enable/disable DDR- RFIM feature for Connectivity. This feature may result in temporary slowdown of the DDR speed.
Preboot BLE	Options: Enabled/Disabled
Discrete Bluetooth Interface	Serial IO UART0 needs to be enabled to select BT interface.
BT Tile Mode	Options: Enabled/Disabled
Advanced Settings	Configure ACPI objects for wireless devices Default: Disabled
WWAN Configuration	Configure WWAN related options. WWAN Device: enable or disable M.2 WWAN device

4.4.2 CPU Configuration



BIOS Setting	Description
Efficient-core Information	Displays the E-core Information.
Performance-core Information	Displays the P-core Information.
Intel (VMX) Virtualization Technology	When enabled, a VMM can utilize the additional hardware capabilities provided by Vanderpool Technology.
Active Performance-cores	Number of P-cores to enable in each processor package. Note: Number of cores and E-cores are looked at together. When both are (o,o), Pcode will enable all cores.
Active Efficient-cores	Number of E-cores to enable in each processor package. Note: Number of cores and E-cores are looked at together. When both are (o,o), Pcode will enable all cores.
Hyperthreading	Options: Enabled/Disabled
AES	Enable/Disable AES (Advanced Encryption Standard)

4.4.3 Power & Performance



BIOS Setting	Description
CPU – Power Management Control	CPU – Power Management Control Options
Intel Speedstep	Allows more than two frequency ranges to be supported
Intel Speed Shift Technology	Enable/Disable Intel Speed Shift Technology support. Enabling will expose the CPPC v2 interface to allow for hardware controlled P-states.
Config TDP Configuration	Configuration Processor Base Power (cTDP) Configuration

4.4.4 PCH-FW Configuration



4.4.5 Trusted Computing



BIOS Setting	Description
Security Device Support	Enables / Disables BIOS support for security device. OS will not show security device. TCG EFI protocol and INT1A interface will not be available.
SHA256 PCR Bank	Options: Enabled / Disabled
SHA384 PCR Bank	Options: Enabled / Disabled
Pending operation	Schedule an operation for the security device. Note: Your computer will reboot during restart in order to change state of security device.
Platform Hierarchy	Enables / Disables platform hierarchy.
Storage Hierarchy	Enables / Disables storage hierarchy.
Endorsement Hierarchy	Enables / Disables endorsement hierarchy.
Physical Presence Spec Version	Select to tell O.S. to support PPI Spec Version 1.2 or 1.3. Note some HCK tests might not support 1.3.
Device Select	TPM 1.2 will restrict support to TPM 1.2 devices. TPM 2.0 will restrict support to TPM 2.0 devices. Auto will support both with the default set to TPM 2.0 devices if not found, TPM 1.2 devices will be enumerated.

4.4.6 ACPI Settings



BIOS Setting	Description
Enable Hibernation	Enables / Disables the system ability to hibernate (OS/S4 Sleep State). This option may be not effective with some OS.

4.4.7 F81966 Super IO Configuration

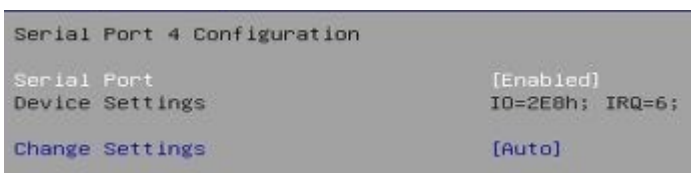
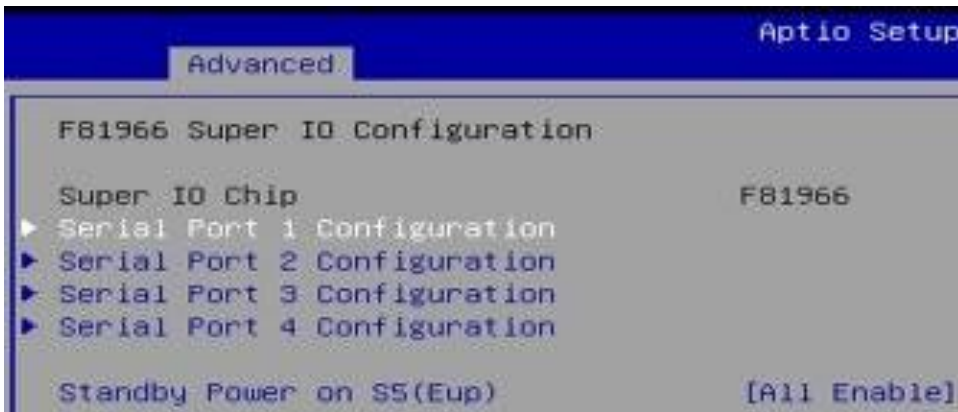

BIOS Setting	Description
Serial Port Configuration	Sets parameters of Serial Port 1/2/3/4
Standby Power on S5 (Eup)	Enable – provide the standby power for devices. Disable – shutdown the standby power.

4.4.8 Hardware Monitor



BIOS Setting	Description
Temperatures / Voltages	These fields are the parameters of the hardware monitoring function feature of the motherboard. The values are read-only values as monitored by the system and show the PC health status.

4.4.9 USB Configuration



BIOS Setting	Description
Legacy USB Support	<ul style="list-style-type: none"> • Enabled enables Legacy USB support. • Auto disables legacy support if there is no USB device connected. • Disabled keeps USB devices available only for EFI applications.
XHCI Hand-off	This is a workaround for OSeS without XHCI hand-off support. The XHCI ownership change should be claimed by XHCI driver.
USB Mass Storage Driver Support	Enables / Disables the support for USB mass storage driver.
USB Transfer time-out	The time-out value (1 / 5 / 10 / 20 secs) for Control, Bulk, and Interrupt transfers.
Device reset time-out	USB mass storage device Start Unit command time-out
Device power-up delay	Maximum time the device will take before it properly reports itself to the Host Controller. ' Auto ' uses default value: for a Root port it is 100ms, for a Hub port the delay is taken from Hub descriptor.

4.4.10 Network Stack Configuration



4.4.11 NVMe Configuration

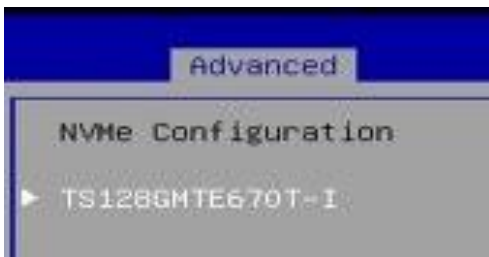

4.5 Chipset Settings



BIOS Setting	Description
System Agent (SA) Configuration	System Agent (SA) parameters
PCH-IO Configuration	PCH parameters

Graphics Configuration:

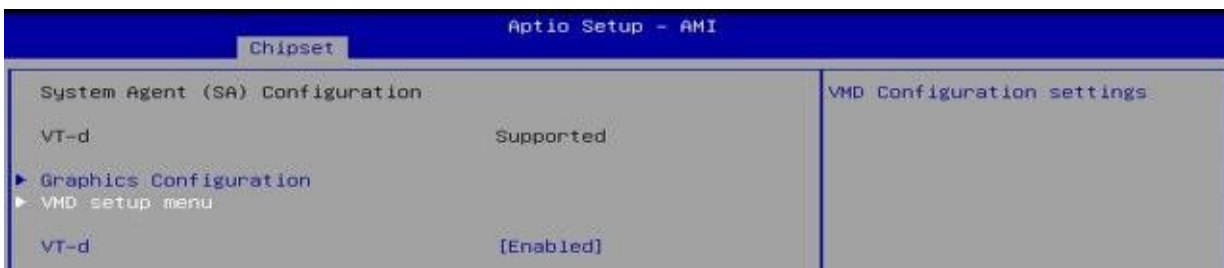

BIOS Setting	Description
Graphics Turbo IMON Current	Graphics turbo IMON current values supported (14-31)
GTT Size	Sets the GTT size as 2 MB, 4 MB, or 8 MB.
Aperture Size	Select the aperture size. Note: Above 4 GB MMIO BIOS assignment is automatically enabled when selecting 2048 MB aperture. To use this feature, disable CSM support.
DVMT Pre-Allocated	Select DVMT 5.0 Pre-Allocated (Fixed) Graphics Memory size used by the Internal Graphics Device
DVMT Total Gfx Mem	Select DVMT5.0 Total Graphic Memory size used by the Internal Graphics Device

VMD setup menu:

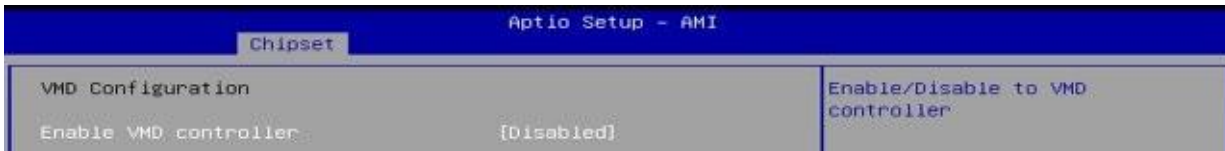
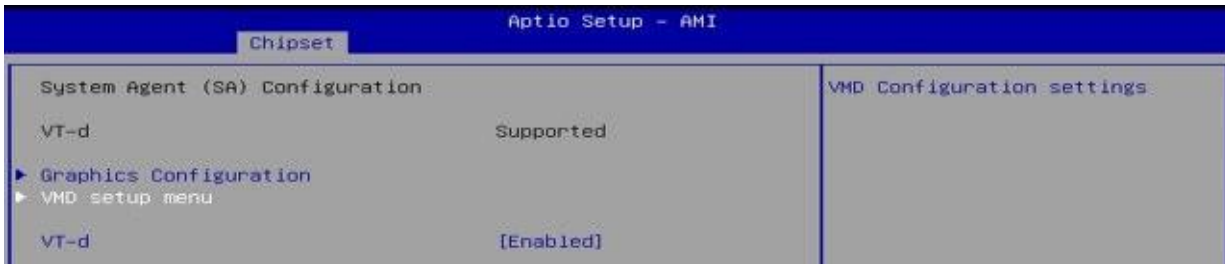

BIOS Setting	Description
VMD setup menu	VMD Configuration settings.
Enable VMD controller	Enable/Disable VMD controller.
Enable VMD Global Mapping	Enable/Disable VMD Global Mapping.
RAID0 / 1 / 5 / 10	Enable/Disable RAID support.
Intel Rapid Recovery Technology	Enable/Disable Intel Rapid Recovery Technology.
RRT volumes can span internal and eSATA drives	Enable/Disable volumes can span internal and eSATA drives.
Intel(R) Optane(TM) Memory	Enable/Disable System Acceleration with Intel(R) Optane(TM) Memory feature .

RAID Configuration Requirement

RAID functionality requires the VMD controller to be enabled in BIOS. The J5 and J10 M.2 M-Key connectors must each be populated with NVMe PCIe SSDs. SATA-based M.2 devices are not supported for RAID operation.

PCH-IO Configuration

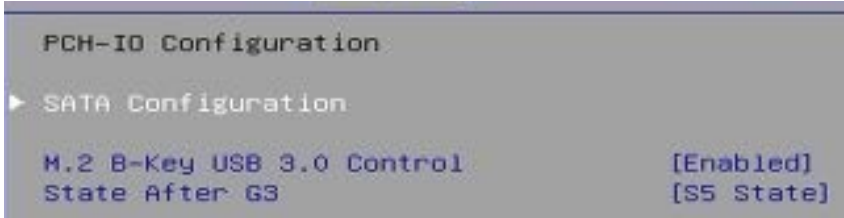
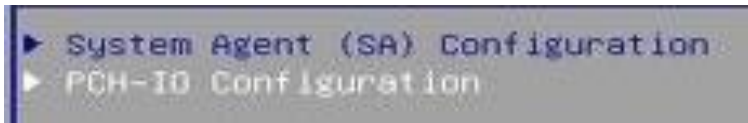

BIOS Setting	Description
SATA Configuration	SATA device options and settings
M.2 B-Key USB 3.0 Control	Enable / disable the USB physical connector. Once disabled, any USB devices plug into the connector will not be detected by BIOS or OS.
State after G3	Specify what state to go to when power is re-applied after a power failure (G3 state).

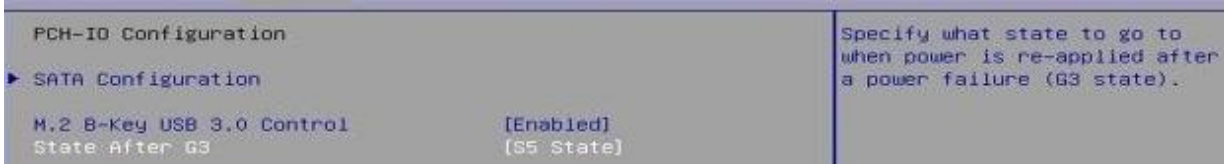

4.6 Security Settings



BIOS Setting	Description
Setup Administrator Password	Sets an administrator password for the setup utility.
User Password	Sets a user password.
Secure Boot	Secure Boot feature is Active if Secure Boot is Enabled. Platform Key(PK) is enrolled and the System is in user mode. The mode change requires platform reset.

System Mode	User	Secure Boot feature is Active if Secure Boot is Enabled, Platform Key(PK) is enrolled and the System is in User mode. The mode change requires platform reset
Secure Boot	[Disabled] Not Active	
Secure Boot Mode	[Standard]	
Restore Factory Keys Reset To Setup Mode		
Key Management		

System Mode	User	Secure Boot mode options: Standard or Custom. In Custom mode, Secure Boot Policy variables can be configured by a physically present user without full authentication
Secure Boot	[Disabled] Not Active	
Secure Boot Mode	[Standard]	
Restore Factory Keys Reset To Setup Mode		
Key Management		

4.7 Boot Settings



BIOS Setting	Description
Setup Prompt Timeout	Number of seconds to wait for setup activation key. 65535 (0xFFFF) means indefinite waiting.
Bootup Num Lock State	Turns on/off the keyboard Num Lock state.
Quiet Boot	Enables / Disables Quiet Boot option.
FIXED BOOT ORDER PRIORITY	Sets the system boot order
UEFI Hard Disk Drive BBS Priorities	Specifies the boot device priority sequence from available UEFI hard disk drives.

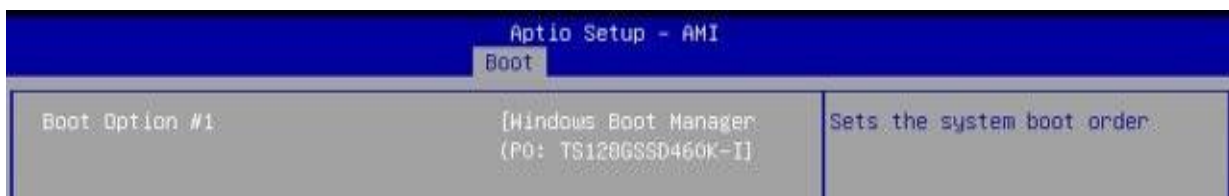

4.8 Save & Exit Settings

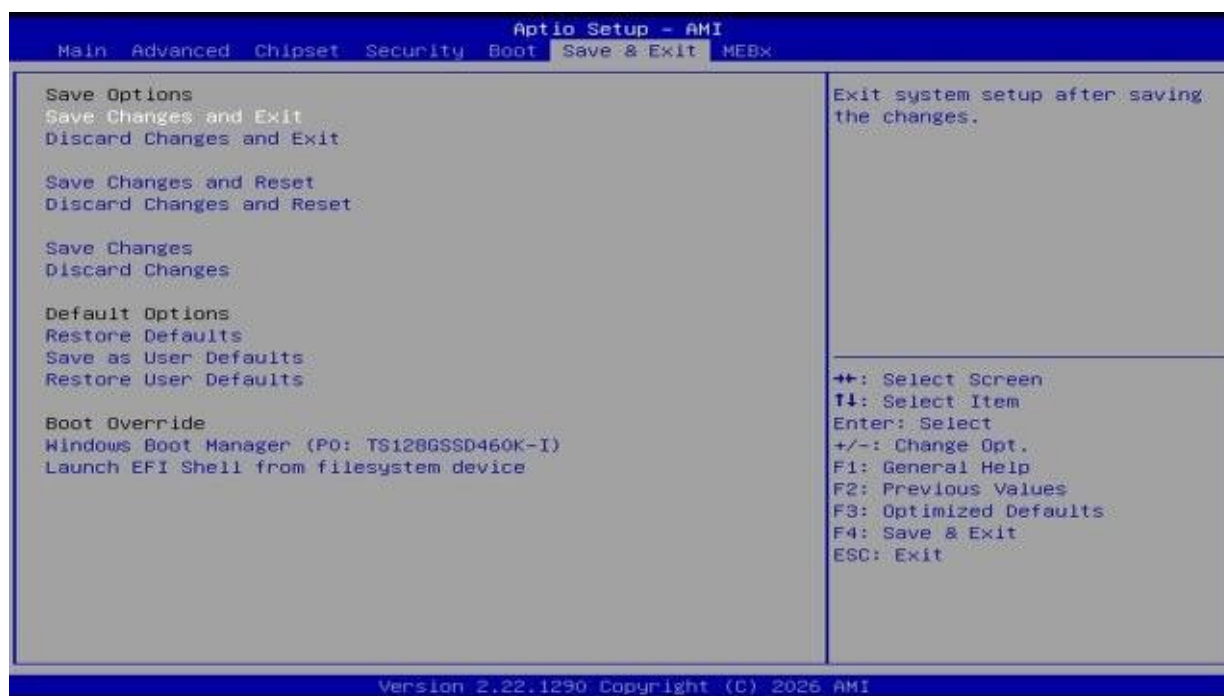

BIOS Setting	Description
Save Changes and Exit	Exits system setup after saving the changes.
Discard Changes and Exit	Exits system setup without saving any changes.
Save Changes and Reset	Resets the system after saving the changes.
Discard Changes and Reset	Resets system setup without saving any changes.
Save Changes	Saves changes done so far to any of the setup options.
Discard Changes	Discards changes done so far to any of the setup options.
Restore Defaults	Restores / Loads defaults values for all the setup options.
Save as User Defaults	Saves the changes done so far as user defaults.
Restore User Defaults	Restores the user defaults to all the setup options.
Launch EFI Shell from filesystem device	Attempts to Launch EFI Shell application (Shell.efi) from one of the available filesystem devices.

This page is intentionally left blank.

Appendix

This section provides the mapping addresses of peripheral devices and the sample code of watchdog timer configuration.

- I/O Port Address Map
- Interrupt Request Lines (IRQ)
- Watchdog Timer Configuration

A. I/O Port Address Map

Each peripheral device in the system is assigned a set of I/O port addresses which also becomes the identity of the device. The following table lists the I/O port addresses used.

Address	Device Description
0x00000A00-0x00000A0F	Motherboard resources
0x00000A10-0x00000A1F	Motherboard resources
0x0000002E-0x0000002F	Motherboard resources
0x0000004E-0x0000004F	Motherboard resources
0x00000061-0x00000061	Motherboard resources
0x00000063-0x00000063	Motherboard resources
0x00000065-0x00000065	Motherboard resources
0x00000067-0x00000067	Motherboard resources
0x00000070-0x00000070	Motherboard resources
0x00000080-0x00000080	Motherboard resources
0x00000092-0x00000092	Motherboard resources
0x000000B2-0x000000B3	Motherboard resources
0x00000680-0x0000069F	Motherboard resources
0x0000164E-0x0000164F	Motherboard resources
0x0000FFF8-0x0000FFFF	Intel(R) Active Management Technology - SOL (COM7)
0x00000020-0x00000021	Programmable interrupt controller
0x00000024-0x00000025	Programmable interrupt controller
0x00000028-0x00000029	Programmable interrupt controller
0x0000002C-0x0000002D	Programmable interrupt controller
0x00000030-0x00000031	Programmable interrupt controller
0x00000034-0x00000035	Programmable interrupt controller
0x00000038-0x00000039	Programmable interrupt controller
0x0000003C-0x0000003D	Programmable interrupt controller
0x000000A0-0x000000A1	Programmable interrupt controller
0x000000A4-0x000000A5	Programmable interrupt controller

0x000000A8-0x000000A9	Programmable interrupt controller
0x000000AC-0x000000AD	Programmable interrupt controller
0x000000B0-0x000000B1	Programmable interrupt controller
0x000000B4-0x000000B5	Programmable interrupt controller
0x000000B8-0x000000B9	Programmable interrupt controller
0x000000BC-0x000000BD	Programmable interrupt controller
0x000004D0-0x000004D1	Programmable interrupt controller
0x000003F8-0x000003FF	Communications Port (COM1)
0x000002F8-0x000002FF	Communications Port (COM2)
0x000003E8-0x000003EF	Communications Port (COM3)
0x000002E8-0x000002EF	Communications Port (COM4)
0x00001854-0x00001857	Motherboard resources
0x00000000-0x00000CF7	PCI Express Root Complex
0x00000D00-0x0000FFFF	PCI Express Root Complex
0x0000EFA0-0x0000EFBF	Intel(R) SMBus - 51A3
0x00003000-0x0000303F	Intel(R) Iris(R) Xe Graphics
0x00002000-0x000020FE	Motherboard resources
0x00003090-0x00003097	Standard SATA AHCI Controller
0x00003080-0x00003083	Standard SATA AHCI Controller
0x00003060-0x0000307F	Standard SATA AHCI Controller
0x00000040-0x00000043	System timer
0x00000050-0x00000053	System timer
0x00000060-0x00000060	Standard PS/2 Keyboard

B. Interrupt Request Lines (IRQ)

Peripheral devices use interrupt request lines to notify CPU for the service required. The following table shows the IRQ used by the devices on board.

Level	Function
IRQ 4294967288	Intel(R) USB 3.20 eXtensible Host Controller - 1.20 (Microsoft)
IRQ 4294967292	Intel(R) PCI Express Root Port #9 - 51B0
IRQ 4294967251~61	Intel(R) Ethernet Controller I226-V
IRQ 14	Intel(R) Serial IO GPIO Host Controller - INTC1055
IRQ 16	High Definition Audio Controller
IRQ 19	Intel(R) Active Management Technology - SOL (COM7)
IRQ 4294967240~50	Intel(R) Ethernet Controller I226-V #2
IRQ 4294967294	Intel(R) PCI Express Root Port #7 - 51BE
IRQ 4294967273~85	Standard NVM Express Controller
IRQ 4294967286	Intel(R) Management Engine Interface #1
IRQ 4	Communications Port (COM1)
IRQ 3	Communications Port (COM2)
IRQ 5	Communications Port (COM3)
IRQ 6	Communications Port (COM4)
IRQ 27	Intel(R) Serial IO I2C Host Controller - 51E8
IRQ 55~204	Microsoft ACPI-Compliant System
IRQ 256~511	Microsoft ACPI-Compliant System
IRQ 4294967262~72	Intel(R) Ethernet Controller I226-LM
IRQ 4294967289	Intel(R) Iris(R) Xe Graphics
IRQ 41	Trusted Platform Module 2.0
IRQ 4294967291	Intel(R) PCI Express Root Port #10 - 51B1
IRQ 4294967290	Standard SATA AHCI Controller
IRQ 0	System timer
IRQ 1	Standard PS/2 Keyboard
IRQ 12	Microsoft PS/2 Mouse
IRQ 4294967287	Intel(R) USB 3.10 eXtensible Host Controller - 1.20 (Microsoft)
IRQ 4294967293	Intel(R) PCI Express Root Port #8 - 51BF

C. Watchdog Timer Configuration

The Watchdog Timer (WDT) is used to generate a variety of output signals after a user programmable count. The WDT is suitable for use in the prevention of system lock-up, such as when software becomes trapped in a deadlock. Under these sorts of circumstances, the timer will count to zero and the selected outputs will be driven.

Under normal circumstance, you will need to restart the WDT at regular intervals before the timer counts to zero.

Sample Code:

```
//-----
//
// THIS CODE AND INFORMATION IS PROVIDED "AS IS" WITHOUT WARRANTY OF ANY
// KIND, EITHER EXPRESSED OR IMPLIED, INCLUDING BUT NOT LIMITED TO THE
// IMPLIED WARRANTIES OF MERCHANTABILITY AND/OR FITNESS FOR A PARTICULAR
// PURPOSE.
//
//-----
#include <dos.h>
#include <conio.h>
#include <stdio.h>
#include <stdlib.h>
#include "F81966.H"
//-----
int main (int argc, char *argv[]);
void EnableWDT(int);
void DisableWDT(void);
//-----
int main (int argc, char *argv[])
{
    unsigned char bBuf;
    unsigned char bTime;
    char **endptr;

    char SIO;

    printf("Fintek 81966 watch dog program\n");
    SIO = Init_F81966();
    if (SIO == 0)
    {
        printf("Can not detect Fintek 81966, program abort.\n");
        return(1);
    }//if (SIO == 0)

    if (argc != 2)
    {
```

iBASE

```
        printf(" Parameter incorrect!!\n");
        return (1);
    }

    bTime = strtol (argv[1], endptr, 10);
    printf("System will reset after %d seconds\n", bTime);

    if (bTime)
    {
        EnableWDT(bTime);
    }
    else
    {
        DisableWDT();
    }
    return 0;
}
//-----
void EnableWDT(int interval)
{
    unsigned char bBuf;

    bBuf = Get_F81966_Reg(0x2B);
    bBuf &= (~0x20);
    Set_F81966_Reg(0x2B, bBuf);    //Enable WDTO

    Set_F81966_LD(0x07);          //switch to logic device 7
    Set_F81966_Reg(0x30, 0x01);  //enable timer

    bBuf = Get_F81966_Reg(0xF5);
    bBuf &= (~0x0F);
    bBuf |= 0x52;
    Set_F81966_Reg(0xF5, bBuf);  //count mode is second

    Set_F81966_Reg(0xF6, interval); //set timer

    bBuf = Get_F81966_Reg(0xFA);
    bBuf |= 0x01;
    Set_F81966_Reg(0xFA, bBuf);  //enable WDTO output

    bBuf = Get_F81966_Reg(0xF5);
    bBuf |= 0x20;
    Set_F81966_Reg(0xF5, bBuf);  //start counting
}
//-----
void DisableWDT(void)
{
    unsigned char bBuf;

    Set_F81966_LD(0x07);          //switch to logic device 7

    bBuf = Get_F81966_Reg(0xFA);
    bBuf &= ~0x01;
    Set_F81966_Reg(0xFA, bBuf);  //disable WDTO output
}
```

```

    bBuf = Get_F81966_Reg(0xF5);
    bBuf &= ~0x20;
    bBuf |= 0x40;
    Set_F81966_Reg(0xF5, bBuf);    //disable WDT
}
//-----

//-----
//
// THIS CODE AND INFORMATION IS PROVIDED "AS IS" WITHOUT WARRANTY OF ANY
// KIND, EITHER EXPRESSED OR IMPLIED, INCLUDING BUT NOT LIMITED TO THE
// IMPLIED WARRANTIES OF MERCHANTABILITY AND/OR FITNESS FOR A PARTICULAR
// PURPOSE.
//
//-----
#include "F81966.H"
#include <dos.h>
//-----
unsigned int F81966_BASE;
void Unlock_F81966 (void);
void Lock_F81966 (void);
//-----
unsigned int Init_F81966(void)
{
    unsigned int result;
    unsigned char ucDid;

    F81966_BASE = 0x4E;
    result = F81966_BASE;

    ucDid = Get_F81966_Reg(0x20);
    if (ucDid == 0x07)        //Fintek 81966
    {   goto Init_Finish;   }

    F81966_BASE = 0x2E;
    result = F81966_BASE;

    ucDid = Get_F81966_Reg(0x20);
    if (ucDid == 0x07)        //Fintek 81966
    {   goto Init_Finish;   }

    F81966_BASE = 0x00;
    result = F81966_BASE;

Init_Finish:
    return (result);
}
//-----
void Unlock_F81966 (void)
{

```

iBASE

```
    outportb(F81966_INDEX_PORT, F81966_UNLOCK);
    outportb(F81966_INDEX_PORT, F81966_UNLOCK);
}
//-----
void Lock_F81966 (void)
{
    outportb(F81966_INDEX_PORT, F81966_LOCK);
}
//-----
void Set_F81966_LD( unsigned char LD)
{
    Unlock_F81966();
    outportb(F81966_INDEX_PORT, F81966_REG_LD);
    outportb(F81966_DATA_PORT, LD);
    Lock_F81966();
}
//-----
void Set_F81966_Reg( unsigned char REG, unsigned char DATA)
{
    Unlock_F81966();
    outportb(F81966_INDEX_PORT, REG);
    outportb(F81966_DATA_PORT, DATA);
    Lock_F81966();
}
//-----
unsigned char Get_F81966_Reg(unsigned char REG)
{
    unsigned char Result;
    Unlock_F81966();
    outportb(F81966_INDEX_PORT, REG);
    Result = inportb(F81966_DATA_PORT);
    Lock_F81966();
    return Result;
}
//-----
```

```
//-----  
//  
// THIS CODE AND INFORMATION IS PROVIDED "AS IS" WITHOUT WARRANTY OF ANY  
// KIND, EITHER EXPRESSED OR IMPLIED, INCLUDING BUT NOT LIMITED TO THE  
// IMPLIED WARRANTIES OF MERCHANTABILITY AND/OR FITNESS FOR A PARTICULAR  
// PURPOSE.  
//  
//-----  
#ifndef F81966_H  
#define F81966_H 1  
//-----  
#define F81966_INDEX_PORT (F81966_BASE)  
#define F81966_DATA_PORT (F81966_BASE+1)  
//-----  
#define F81966_REG_LD 0x07  
//-----  
#define F81966_UNLOCK 0x87  
#define F81966_LOCK 0xAA  
//-----  
unsigned int Init_F81966(void);  
void Set_F81966_LD( unsigned char);  
void Set_F81966_Reg( unsigned char,  
unsigned char); unsigned char  
Get_F81966_Reg( unsigned char);  
//-----  
#endif // F81966_H
```