

IB891

Intel® Pineview-M/ Pineview-D +ICH8M
Luna-Pier / Luna-Pier Refresh Platform
3.5" Disk Size SBC

USER'S MANUAL

Version 1.0B

Acknowledgments

AMI BIOS is a trademark of American Megatrends Inc.

PS/2 is a trademark of International Business Machines Corporation.

Intel and Luna-Pier are registered trademarks of Intel Corporation.

Microsoft Windows is a registered trademark of Microsoft Corporation.

Winbond is a registered trademark of Winbond Electronics Corporation.

All other product names or trademarks are properties of their respective owners.

Table of Contents

Introduction	1
Product Description.....	1
Checklist.....	2
IB891 Specifications	3
Board Dimensions	4
Installations	5
Installing the Memory	6
Setting the Jumpers	7
Connectors on IB891.....	11
BIOS SETUP	19
Drivers Installation	39
Appendix	47
A. I/O Port Address Map.....	47
B. Interrupt Request Lines (IRQ).....	48
C. Watchdog Timer Configuration.....	49
D. Digital I/O Sample Code	54

This page is intentionally left blank.

Introduction

Product Description

The IB891 is a 3.5-inch single board computer based on a two-chip the Intel® Atom™ single-core N450 or dual-core D510 processor. The processors come integrated with both a memory controller and an IGP graphics core with 200MHz (N450) and 400MHz (D510) of GPU frequency. The IB891 performs with low power consumption and better hardware decode on graphics intensive and multimedia applications for the digital signage, POS/kiosk, automation and other fanless and low-noise embedded applications.

Measuring 102mm x 147mm, the IB891 has a 3D-capable built-in Intel® graphics engine that support DirectX 9 and OpenGL 1.4, with an 18-bit single channel LVDS interface and a VGA CRT port edge connector. The board offers essential features and high-speed connectivity including two gigabit LAN, watchdog timer, digital I/O, eight USB 2.0 ports, four serial ports and CF socket. Expansion is provided by a Mini PCI-e connector that can be used for wireless LAN or TV-tuner modules.

Checklist

Your IB891 package should include the items listed below.

- The IB891 3.5" disk-size SBC
- This User's Manual
- 1 CD containing chipset drivers and flash memory utility

Remarks: The IB60 cable kit (USB, COM, SATA, power) is optional.

IB891 Specifications

Product Name	IB891 (SC) /IB891-D5 (DC)
Form Factor	3.5" SBC
CPU Type	Intel® Pineview-M SC / Pineview-D DC Processor
CPU Speed	Intel® Atom™ SC N450 / 512K cache/1.66 GHz (5.5W) Intel® Atom™ DC D510 / 1MB cache/1.66GHz (14.5W) 22mm x 22mm, Micro-FCBGA8
Green /APM	APM1.2
BIOS	AMI BIOS, support ACPI Function
Chipset	ICH8M: 31mm x 31mm, 676-pin T-PBGA (2.4W)
Memory	DDR2 667MHz SO-DIMM x 1 (w/o ECC), Max. 2GB / 4GB , Single channel
VGA	Intel® Integrated Graphics Controller Supports DirectX 9 Graphic (200MHz/ 400MHz), OpenGL 1.4
LVDS	18-bit one channels LVDS interface w/DF13 socket x1
LAN	Realtek 8111DL x 2
USB	ICH8M built-in USB 2.0 host controller, support 8 ports
Serial ATA Ports	ICH8M built-in SATA controller, supports 2 ports
Parallel IDE	ICH8M built-in one channel Ultra DMA 33/66/100, for CF Type II
Audio	Intel ICH8M built-in audio controller w/ Realtek ALC662 Codec (supports 5.1 CH audio & SSM2304 2W/4ohm Amplifier)
LPC I/O	Winbond W83627UHG : COM1 (RS232/422/485), COM2(RS232) COM3(RS232) & COM4(RS232) with pin-9 with power for 2 ports (500 mA for each port) Hardware monitor (2 thermal inputs, 4 voltage monitor inputs, VID0-4 & 1 x Fan Header)
Digital IO	4 in & 4 out
Keyboard/Mouse Connector	Pin header
Expansion Slots	Mini PCI-e socket x 1 for Wireless LAN or TV-tuner module
Edge Connector	DB15 x1 for VGA RJ45 x2 for LAN 1&2 USB stack connector x 1 for USB1 ~2 DB9 x 1 for COM1
On Board Header/Connector	2x5 pin header for KB/MS 2x4 pins header x 3 for 6 USB ports DF13 socket connector x 1 for 18-bit single channel LVDS 2x6 pins box header x1 for Audio 4 pins header x1 for speaker 2x5 pins box header x 1 for COM2 2x10 pins box header x 1 for COM3 ~4 2x5 pins headers x 1 for LPC(80-port card debugging purpose) Mini PCI-e(1x) connector x 1 Compact Flash socket x 1 5 pins box header x 1 for smart battery 4 pins box header x 1 for backlight/brightness control 4-pins power connector for SATA HDD
Watchdog Timer	Yes (256 segments, 0, 1, 2...255 sec/min)
Power Connector	+12V DC-in
RoHS	Yes
Board Size	102mm x 147mm

Board Dimensions

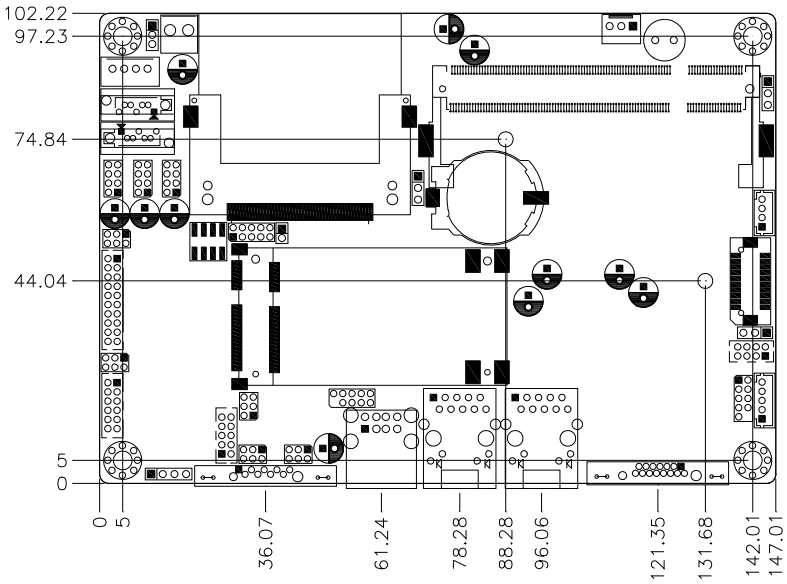

Installations

This section provides information on how to use the jumpers and connectors on the IB891 in order to set up a workable system. The topics covered are:

Installing the Memory	6
Setting the Jumpers.....	7
Connectors on IB891	11

Installing the Memory

The IB891 board supports one DDR667 DDR2 memory.

Remarks:

N450 supports SO-DIMM x 1 (w/o ECC), Max. 2GB , Single channel

D510 supports SO-DIMM x 1 (w/o ECC), Max. 2GB , Single channel

Installing and Removing Memory Modules

To install the DDR2 modules, locate the memory slot on the board and perform the following steps:

1. Hold the DDR2 module so that the key of the DDR2 module aligns with that on the memory slot. Insert the module into the socket at a slight angle (approximately 30 degrees). Note that the socket and module are both keyed, which means that the module can be installed only in one direction.
2. To seat the memory module into the socket, apply firm and even pressure to each end of the module until you feel it slip down into the socket.
3. With the module properly seated in the socket, rotate the module downward. Continue pressing downward until the clips at each end lock into position.
4. To remove the DDR2 module, press the clips with both hands.

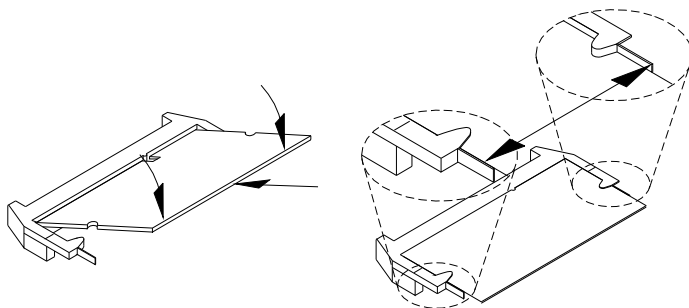

Setting the Jumpers

Jumpers are used on IB891 to select various settings and features according to your needs and applications. Contact your supplier if you have doubts about the best configuration for your needs. The following lists the connectors on IB891 and their respective functions.

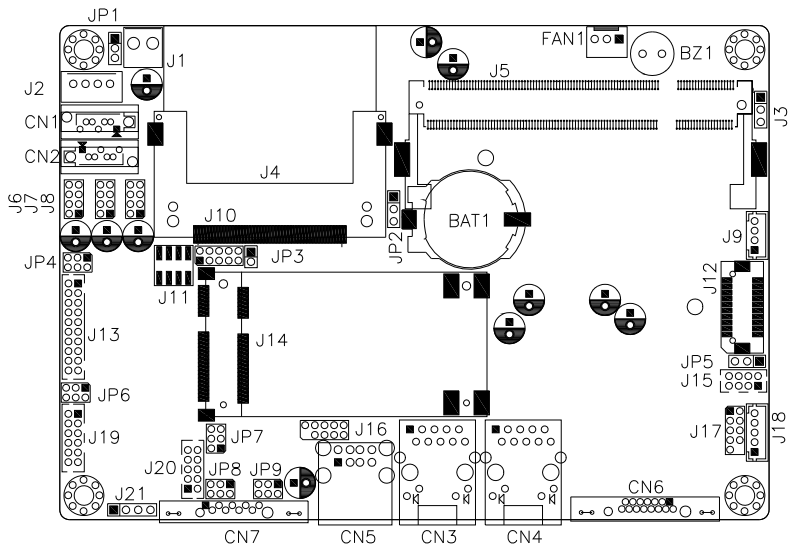

Jumper Locations on IB891.....	8
JP1: ATX/AT Mode Select.....	9
JP2: Clear CMOS Setting	9
JP3: Compact Flash Slave/Master Selection	9
JP5: LCD Panel Power Selection	9
JP4, JP6: COM3/4 RS232 +5V/+12V Power Setting.....	10
JP7, JP8, JP9: RS232/422/485 (COM1) Selection	10

Jumper Locations on IB891





Jumpers on IB891.....	Page
JP1: ATX/AT Mode Select.....	9
JP2: Clear CMOS Setting.....	9
JP3: Compact Flash Slave/Master Selection.....	9
JP5: LCD Panel Power Selection.....	9
JP4, JP6: COM3/4 RS232 +5V/+12V Power Setting.....	10
JP7, JP8, JP9: RS232/422/485 (COM1) Selection.....	10

JP1: ATX/AT Mode Select



JP1	ATX / AT
 1 2 3	ATX mode
 1 2 3	AT mode

JP2: Clear CMOS Setting



JP2	Setting
 1 2 3	Normal
 1 2 3	Clear CMOS

Note: Please remove the lithium battery before setting the jumper.

JP3: Compact Flash Slave/Master Selection

JP3	CF Setting
 Short	Master
 Open	Slave

JP5: LCD Panel Power Selection

JP5	LCD Panel Power
 1 2 3	3.3V
 1 2 3	5V

JP4, JP6: COM3/4 RS232 +5V/+12V Power Setting

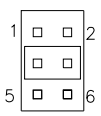
JP4/JP6	Setting	Function
	Pin 1-2 Short/Closed	+12V
	Pin 3-4 Short/Closed	Normal
	Pin 5-6 Short/Closed	+5V

JP7, JP8, JP9: RS232/422/485 (COM1) Selection

COM2, COM3, COM4 are fixed for RS-232 use only.

COM1 is selectable for RS232, RS-422 and RS-485.

The following table describes the jumper settings for COM1 selection.

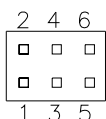

COM1 Function	RS-232	RS-422	RS-485
Jumper Setting (pin closed)	JP7: 1-2	JP7: 3-4	JP7: 5-6
	JP8: 3-5 & 4-6	JP8: 1-3 & 2-4	JP8: 1-3 & 2-4
	JP9: 3-5 & 4-6	JP9: 1-3 & 2-4	JP9: 1-3 & 2-4

Connectors on IB891

Connector Locations on IB891	12
CN1, CN2: SATA Connectors	13
CN3, CN4: Gigabit LAN RJ45 Connector	13
CN5: USB 1/2 Connector	13
CN6: VGA Connector	13
CN7: COM1 RS232/RS422/RS485 Connector	13
J1: Board Input Power Connector	14
J2: HDD Power Connector	14
J3: Power LED	14
J4: Compact Flash Connector	14
J5: DDR2 SO-DIMM	14
J6, J7, J8: USB3/4/5/6/7/8 Connector	14
J9: LCD Backlight Connector	14
J10: Digital I/O	15
J11: System Function Connector	15
J12 : LVDS(18bit) Connectors	16
J13: COM3, COM4 Serial Port (DF11 Connector)	16
J14: Mini PCIE Connector	16
J15: Keyboard & Mouse Connector (DF11 Connector)	16
J16: SPI Flash Connector (factory use only)	16
J17: LPC Connector (factory use only)	16
J18: Smart Battery Interface Connector	17
J19: Audio Connector (DF11 Connector)	17
J20: COM2/RS232 Serial Port	17
J21: Amplify Connector	17

Connector Locations on IB891

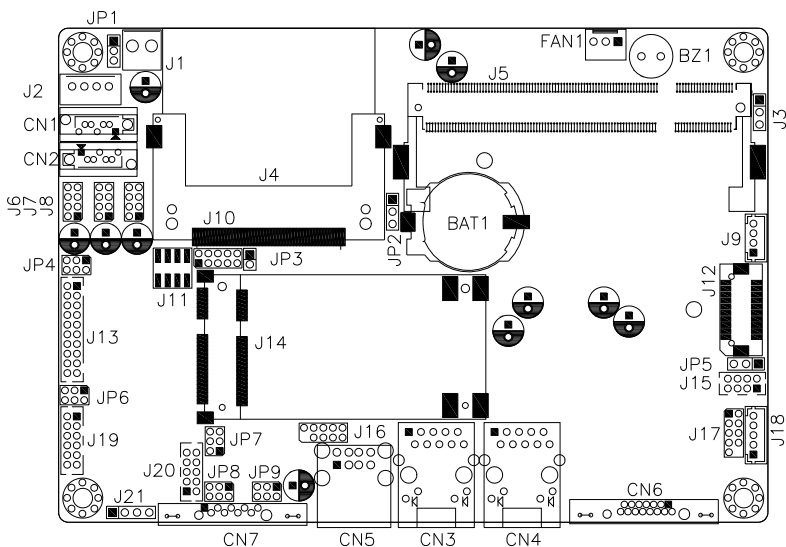

Connectors on IB891	Page
CN1, CN2: SATA Connectors	13
CN3, CN4: Gigabit LAN RJ45 Connector	13
CN5: USB 1/2 Connector	13
CN6: VGA Connector	13
CN7: COM1 RS232/RS422/RS485 Connector	13
J1: Board Input Power Connector	14
J2: HDD Power Connector (Output Only)	14
J3: Power LED	14
J4: Compact Flash Connector	14
J5: DDR2 SO-DIMM	14
J6, J7, J8: USB3/4/5/6/7/8 Connector	14
J9: LCD Backlight Connector	14
J10: Digital I/O	15
J11: System Function Connector	15
J12 : LVDS(18bit) Connectors	16
J13: COM3, COM4 Serial Port (DF11 Connector)	16
J14: Mini PCIE Connector	16
J15: Keyboard & Mouse Connector (DF11 Connector)	16
J16: SPI Flash Connector (factory use only)	16
J17: LPC Connector (factory use only)	16
J18: Smart Battery Interface Connector	17
J19: Audio Connector (DF11 Connector)	17
J20: COM2/RS232 Serial Port	17
J21: Amplify Connector	17

CN1, CN2: SATA Connectors

CN3, CN4: Gigabit LAN RJ45 Connector

CN5: USB 1/2 Connector

CN6: VGA Connector

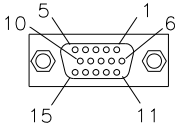

VGA

Signal Name	Pin #	Pin #	Signal Name
Red	1	2	Green
Blue	3	4	N.C.
GND	5	6	GND
GND	7	8	GND
VCC	9	10	GND
N.C.	11	12	DDCDATA
HSYNC	13	14	VSYNC
DDCCLK	15		

CN7: COM1 RS232/RS422/RS485 Connector

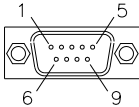

Pin #	Signal Name		
	RS-232	R2-422	RS-485
1	DCD	TX-	DATA-
2	RX	TX+	DATA+
3	TX	RX+	NC
4	DTR	RX-	NC
5	Ground	Ground	Ground
6	DSR	NC	NC
7	RTS	NC	NC
8	CTS	NC	NC
9	RI	NC	NC
10	NC	NC	NC

J1: Board Input Power Connector



Pin #	Signal Name
1	+12V
2	GND

J2: HDD Power Connector (Output Only)



Pin #	Signal Name
1	+5V
2	Ground
3	Ground
4	+12V

J3: Power LED

The power LED indicates the status of the main power switch.



Pin #	Signal Name
1	Power LED
2	No connect
3	Ground

J4: Compact Flash Connector

J5: DDR2 SO-DIMM

J6, J7, J8: USB3/4/5/6/7/8 Connector

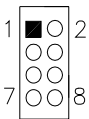

Signal Name	Pin	Pin	Signal Name
Vcc	1	2	Ground
D-	3	4	D+
D+	5	6	D-
Ground	7	8	Vcc

J9: LCD Backlight Connector

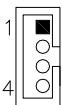

Pin #	Signal Name
1	+12V
2	Backlight Enable
3	Brightness Control
4	Ground

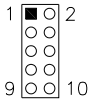
J10: Digital I/O

Signal Name	Pin	Pin	Signal Name
GND	1	2	VCC
OUT3	3	4	OUT1
OUT2	5	6	OUT0
IN3	7	8	IN1
IN2	9	10	IN0

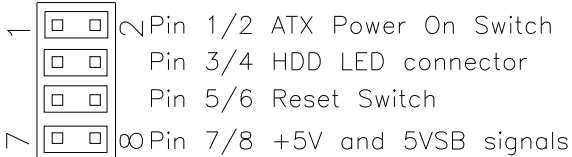
J11: System Function Connector**ATX Power ON Switch: Pins 1 and 2**

This 2-pin connector is an “ATX Power Supply On/Off Switch” on the system that connects to the power switch on the case. When pressed, the power switch will force the system to power on. When pressed again, it will force the system to power off.

Hard Disk Drive LED Connector: Pins 3 and 4

This connector connects to the hard drive activity LED on control panel. This LED will flash when the HDD is being accessed.

Pin #	Signal Name
4	HDD Active
3	5V

Reset Switch: Pins 5 and 6

The reset switch allows the user to reset the system without turning the main power switch off and then on again. Orientation is not required when making a connection to this header.

+5V and 5VSB Signals: Pins 7 and 8

Pin #	Signal Name
7	+5V
8	+5VSB

J12 : LVDS(18bit) Connectors

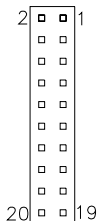

Signal Name	Pin #	Pin #	Signal Name
TX0-	2	1	TX0+
Ground	4	3	Ground
TX1-	6	5	TX1+
5V/3.3V	8	7	Ground
NC	10	9	NC
TX2-	12	11	TX2+
Ground	14	13	Ground
TXC-	16	15	TXC+
5V/3.3V	18	17	ENABKL
+12V	20	19	+12V

J13: COM3, COM4 Serial Port (DF11 Connector)

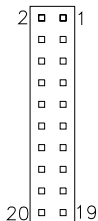

Signal Name	Pin #	Pin #	Signal Name
DSR3	2	1	DCD3
RTS3	4	3	RXD3
CTS3	6	5	TXD3
RI3	8	7	DTR3
NC	10	9	Ground
DSR4	12	11	DCD4
RTS4	14	13	RXD4
CTS4	16	15	TXD4
RI4	18	17	DTR4
NC	20	19	Ground

J14: Mini PCIE Connector

J15: Keyboard & Mouse Connector (DF11 Connector)

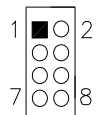

Signal Name	Pin	Pin	Signal Name
VCC	1	2	VCC
MDA	3	4	KBDA
MCL	5	6	KBCL
Ground	7	8	Ground

J16: SPI Flash Connector (factory use only)

J17: LPC Connector (factory use only)

J18: Smart Battery Interface Connector



Pin #	Signal Name
1	RST
2	EXTSMI
3	Ground
4	DATA
5	CLK

J19: Audio Connector (DF11 Connector)

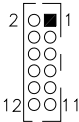

Signal Name	Pin #	Pin #	Signal Name
LINEOUT R	2	1	LINEOUT L
Ground	4	3	JD FRONT
LINEIN R	6	5	LINEIN L
Ground	8	7	JD LINEIN
MIC-In	10	9	MIC L
Ground	12	11	JD MIC1

J20: COM2/RS232 Serial Port



Signal Name	Pin #	Pin #	Signal Name
DCD, Data carrier detect	1	2	RXD, Receive data
TXD, Transmit data	3	4	DTR, Data terminal ready
GND, ground	5	6	DSR, Data set ready
RTS, Request to send	7	8	CTS, Clear to send
RI, Ring indicator	9	10	Not Used

J21: Amplify Connector

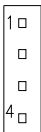

Pin #	Signal Name
1	OUTL+
2	OUTL-
3	OUTR-
4	OUTR+

This page is intentionally left blank.

BIOS SETUP

This chapter describes the different settings available in the AMI (American Megatrends, Inc.) BIOS that comes with the board. The topics covered in this chapter are as follows:

BIOS Introduction	19
BIOS Setup.....	20
Main BIOS Setup	21
Advanced Settings	22
Advanced PCI/PnP Settings	30
Boot Settings	31
Security Settings.....	33
Advanced Chipset Settings.....	34
Exit Options.....	37

BIOS Introduction

The BIOS (Basic Input/Output System) installed in your computer system's ROM supports Intel processors. The BIOS provides critical low-level support for a standard device such as disk drives, serial ports and parallel ports. It also adds virus and password protection as well as special support for detailed fine-tuning of the chipset controlling the entire system.

BIOS Setup

The BIOS provides a Setup utility program for specifying the system configurations and settings. The BIOS ROM of the system stores the Setup utility. When you turn on the computer, the BIOS is immediately activated. Pressing the key immediately allows you to enter the Setup utility. If you are a little bit late pressing the key, POST (Power On Self Test) will continue with its test routines, thus preventing you from invoking the Setup. If you still wish to enter Setup, restart the system by pressing the "Reset" button or simultaneously pressing the <Ctrl>, <Alt> and <Delete> keys. You can also restart by turning the system Off and back On again. The following message will appear on the screen:

```
Press <DEL> to Enter Setup
```

In general, you press the arrow keys to highlight items, <Enter> to select, the <PgUp> and <PgDn> keys to change entries, <F1> for help and <Esc> to quit.

When you enter the Setup utility, the Main Menu screen will appear on the screen. The Main Menu allows you to select from various setup functions and exit choices.

Main BIOS Setup

This setup allows you to record some basic hardware configurations in your computer system and set the system clock.

BIOS SETUP UTILITY						
Main	Advanced	PCIPnP	Boot	Security	Chipset	Exit
System Overview				Use [ENTER], [TAB] or [SHIFT-TAB] to select a field.		
Processor				Use [+] or [-] to configure system Time.		
Intel(R) Atom (TM) CPU N450		@ 1.66GHz				
Speed : 1666MHz						
Count : 1						
System Memory				<- Select Screen		
Size : 1015MB				↑↓ Select Item		
System Time				+- Change Field		
System Date		[17:00:00]		Tab Select Field		
		[Fri 12/18/2009]		F1 General Help		
				F10 Save and Exit		
				ESC Exit		

Note: *If the system cannot boot after making and saving system changes with Setup, the AMI BIOS supports an override to the CMOS settings that resets your system to its default.*

Warning: *It is strongly recommended that you avoid making any changes to the chipset defaults. These defaults have been carefully chosen by both AMI and your system manufacturer to provide the absolute maximum performance and reliability. Changing the defaults could cause the system to become unstable and crash in some cases.*

Advanced Settings

This section allows you to configure and improve your system and allows you to set up some system features according to your preference.

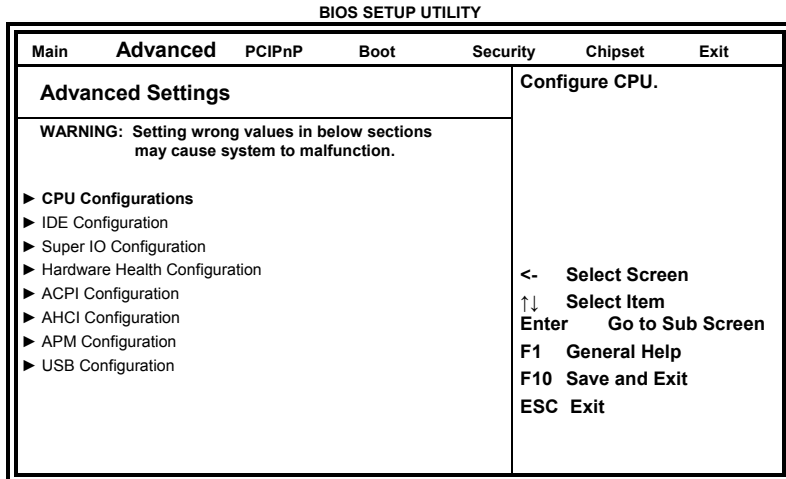

The Advanced BIOS Settings contains the following sections:

- ▶ CPU Configurations
- ▶ IDE Configuration
- ▶ Super IO Configuration
- ▶ Hardware Health Configuration
- ▶ ACPI Configuration
- ▶ AHCI Configuration
- ▶ APM Configuration
- ▶ USB Configuration

The fields in each section are shown in the following pages, as seen in the computer screen. Please note that setting the wrong values may cause the system to malfunction. If unsure, please contact technical support of your supplier.

BIOS SETUP UTILITY

Advanced	
Configure advanced CPU settings	
Module Version:3F.18	
Manufacturer: Intel	
Intel(R) Atom (TM) CPU N450	@ 1.66GHz
Frequency	: 1.66GHz
FSB Speed	: 666MHz
Cache L1	: 24KB
Cache L2	: 512KB
Ratio Actual Value	: 10
Max CPUID Value Limit	[Disabled]
Execute-Disable Bit Capability	[Enabled]
Hyper Threading Technology	[Enabled]
Intel SpeedStep(tm) tech	[Enabled]
Disabled for WindowsXP <- Select Screen ↑↓ Select Item +- Change Field F1 General Help F10 Save and Exit ESC Exit	

The CPU Configuration menu shows the following CPU details: Manufacturer: the name of the CPU manufacturer

Brand String: the brand name of the CPU being used

Frequency: the CPU processing speed

FSB Speed: the FSB speed

Cache L1: the CPU L1 cache size

Cache L2: the CPU L2 cache

Max CPUID Value Limit

Disabled for WindowsXP.

Execute-Disable Bit Capability

XD can prevent certain classes of malicious buffer overflow attacks when combined with a supporting OS.

Hyper Threading Technology

Enabled for Windows XP and Linux (OS optimized for Hyper-Threading Technology) and Disabled for other OS (OS not optimized for Hyper-Threading Technology). When Disabled, only one thread per enabled core is enabled.

Intel SpeedStep(tm) tech (Pineview-M)

Disabled: Disable GV3

Enabled: Enable GV3

BIOS SETUP UTILITY

Advanced		Options
IDE Configuration		
ATA/IDE Configuration	[Enhanced]	Disabled Compatible Enhanced <- Select Screen ↑↓ Select Item +- Change Field F1 General Help F10 Save and Exit ESC Exit
Configure SATA as	[IDE]	
▶ Primary IDE Master	: [Not Detected]	
▶ Primary IDE Slave	: [Not Detected]	
▶ Secondary IDE Master	: [Not Detected]	
▶ Secondary IDE Slave	: [Not Detected]	
▶ Third IDE Master	: [Not Detected]	
▶ Third IDE Slave	: [Not Detected]	
▶ Fourth IDE Master	: [Not Detected]	
▶ Fourth IDE Slave	: [Not Detected]	
Hard Disk Write Protect	[Disabled]	
IDE Detect Time Out (Sec)	[35]	
ATA(Pi) 80Pin Cable Detection	[Host & Device]	

The IDE Configuration menu is used to change and/or set the configuration of the IDE devices installed in the system.

ATA/IDE Configuration

- (1) Disabled.
- (2) Compatible.
- (3) Enhanced

Configure SATA as

- (1) IDE Mode.
- (2) AHCI Mode.

BIOS SETUP UTILITY

Advanced		Allows BIOS to Select Serial Port Base Addresses
Configure Win627UHG Super IO Chipset		
Serial Port1 Address	[3F8/IRQ4]	<- Select Screen ↑↓ Select Item +- Change Field F1 General Help F10 Save and Exit ESC Exit
Serial Port2 Address	[2F8/IRQ3]	
Serial Port3 Address	[3E8]	
Serial PortC IRQ	[IRQ11]	
Serial Port4 Address	[2E8]	
Serial PortD IRQ	[IRQ10]	
Restore on AC Power Loss	[Power Off]	
Backlight	Turn On	

Onboard Serial Port

The default values are:

- Serial Port 1: 3F8/IRQ4
- Serial Port 2: 2F8/IRQ3
- Serial Port 3: 3E8/IRQ11
- Serial Port 4: 2E8/IRQ10

Restore on AC Power Loss

This field sets the system power status whether *Power On* or *Power Off* when power returns to the system from a power failure situation.

BIOS SETUP UTILITY

Advanced		Options
Hardware Health Configuration		
System Temperature	:51°C/123°F	Disabled
CPU Temperature	:47°C/116°F	70°C/158°F
CPU FAN Speed	:0 RPM	75°C/167°F
Vcore	:0.968 V	80°C/176°F
+5VS	:5.338 V	85°C/185°F
+3VS	:3.200 V	90°C/194°F
12 V	:11.904 V	95°C/203°F
3.3V	:3.424 V	
1.5V	:1.504V	<- Select Screen
VBAT	: 3.536V	↑↓ Select Item
ACPI Shutdown Temperature	[Disabled]	+ - Change Field
		Tab Select Field
		F1 General Help
		F10 Save and Exit
		ESC Exit

The Hardware Health Configuration menu is used to show the operating temperature, fan speeds and system voltages.

ACPI Shutdown Temperature

The system will shut down automatically under OS with ACPI mode, when the CPU temperature reaches the configured temperature.

BIOS SETUP UTILITY

Advanced	
ACPI Settings	General ACPI Configuration settings
<ul style="list-style-type: none"> ▶ General ACPI Configuration ▶ Advanced ACPI Configuration ▶ Chipset ACPI Configuration 	<p><- Select Screen ↑↓ Select Item Enter Go to Sub Screen F1 General Help F10 Save and Exit ESC Exit</p>

BIOS SETUP UTILITY

Advanced	
General ACPI Configuration	Select the ACPI state used for System Suspend.
Suspend mode [S1 (POS)]	<p><- Select Screen ↑↓ Select Item +- Change Field F1 General Help F10 Save and Exit ESC Exit</p>

Suspend Mode

The options of this field are *S1*, *S3* and *Auto*.

BIOS SETUP UTILITY

Advanced	
Advance ACPI Configuration	Enable RSDP pointers to 64-bit Fixed System Description Tables. Different ACPI version Has some addition
ACPI Version Features [ACPI v1.0] ACPI APIC support [Enabled]	<p><- Select Screen ↑↓ Select Item +- Change Field F1 General Help F10 Save and Exit ESC Exit</p>

BIOS SETUP UTILITY

Advanced	
South Bridge ACPI Configuration	Options
Energy Lake Feature [Disabled]	Enabled
APIC ACPI SCI IRQ [Disabled]	Disabled
	<- Select Screen ↑↓ Select Item +- Change Field F1 General Help F10 Save and Exit ESC Exit

BIOS SETUP UTILITY

Advanced	
AHCI Settings	While entering setup, BIOS auto detect the presence of IDE device. This displays the status of auto detection of IDE devices.
AHCI Port0 [Not Detected]	
AHCI Port1 [Not Detected]	
AHCI Port2 [Not Detected]	
	<- Select Screen ↑↓ Select Item +- Change Field F1 General Help F10 Save and Exit ESC Exit

BIOS SETUP UTILITY

Advanced	
APM Configuration	Enable or disable APM.
Power Management/APM [Enabled]	
Power Button Mode [On/Off]	
Resume On Ring Disabled	
Resume On PME# Disabled	
Resume On RTC Alarm Disabled	
	<- Select Screen ↑↓ Select Item +- Change Field F1 General Help F10 Save and Exit ESC Exit

Power Management/APM

By default, this field is set to *Enabled*.

Power Button Mode

Go into On/Off, or Suspend when power button is pressed.

Resume on Ring

This option is used to enable activity on the RI (ring in) modem line to wake up the system from a suspend or standby state. That is, the system will be awakened by an incoming call on a modem.

Resume on PME#

This option is used enable activity on the PCI PME (power managementevent) controller to wake up the system from a suspend or standby state

Resume On RTC Alarm

This option is used to specify the time the system should be awakened from a suspended state

BIOS SETUP UTILITY

Advanced	
USB Configuration	Enables support for legacy USB. AUTO option disables legacy support if no USB devices are connected. <- Select Screen ↑↓ Select Item +- Change Field F1 General Help F10 Save and Exit ESC Exit
USB Devices Enabled: None Legacy USB Support [Enabled] USB 2.0 Controller Mode [HiSpeed] BIOS EHCI Hand-Off [Enabled] Legacy USB1.1 HC Support [Enabled]	

The USB Configuration menu is used to read USB configuration information and configure the USB settings.

Legacy USB Support

Enables support for legacy USB. AUTO option disables legacy support if no USB devices are connected.

USB 2.0 Controller Mode

Configures the USB 2.0 controller in HiSpeed (480Mbps) or FullSpeed (12Mbps). This option is enabled by HiSpeed.

BIOS EHCI Hand-Off

Enabled/Disabled. This is a workaround for Oses without EHCI hand-off support. The EHCI ownership change should be claimed by EHCI driver.

Legacy USB1.1 HC Support

Support USB1.1 HC.

PCIPnP Settings

This option configures the PCI/PnP settings.

BIOS SETUP UTILITY			
Main	Advanced	PCIPnP	Boot Security Chipset Exit
Advanced PCI/PnP Settings			
WARNING: Setting wrong values in below sections may cause system to malfunction.			
Plug & Play O/S		[No]	
Allocate IRQ to PCI VGA		[Yes]	
IRQ3		[Available]	
IRQ4		[Available]	
IRQ5		[Available]	
IRQ7		[Available]	
IRQ9		[Available]	
IRQ10		[Available]	
IRQ11		[Available]	
IRQ14		[Available]	
IRQ15		[Available]	
DMA Channel 0		[Available]	
DMA Channel 1		[Available]	
DMA Channel 3		[Available]	
DMA Channel 5		[Available]	
DMA Channel 6		[Available]	
DMA Channel 7		[Available]	
Reserved Memory Size		[Disabled]	
		NO: lets the BIOS Configure all the Devices in the system. YES: lets the operating system configure Plug and Play (PnP) devices not required for boot if your system has a Plug and Play operating system.	
		<- Select Screen ↑↓ Select Item +- Change Field F1 General Help F10 Save and Exit ESC Exit	

Plug & Play O/S

This lets BIOS configure all devices in the system or lets the OS configure PnP devices not required for boot if your system has a Plug and Play OS.

Allocate IRQ to PCI VGA

This assigns IRQ to PCI VGA card if card requests IRQ or doesn't assign IRQ to PCI VGA card even if card requests an IRQ.

IRQ#

Use the IRQ# address to specify what IRQs can be assigned to a particular peripheral device.

Boot Settings

BIOS SETUP UTILITY						
Main	Advanced	PCIPnP	Boot	Security	Chipset	Exit
Boot Settings			Configure Settings during System Boot.			
▶ Boot Settings Configuration			<- Select Screen ↑↓ Select Item +- Change Field Enter Go to Sub Screen F1 General Help F10 Save and Exit ESC Exit			

BIOS SETUP UTILITY	
Boot	
Boot Settings Configuration	
Quick Boot	[Enabled]
Quiet Boot	[Disabled]
AddOn ROM Display Mode	[Force BIOS]
Bootup Num-Lock	[On]
PS/2 Mouse Support	[Auto]
Wait for 'F1' If Error	[Enabled]
Hit 'DEL' Message Display	[Enabled]
Interrupt 19 Capture	[Disabled]
Allows BIOS to skip certain tests while booting. This will decrease the time needed to boot the system.	
<- Select Screen ↑↓ Select Item +- Change Field F1 General Help F10 Save and Exit ESC Exit	

Quick Boot

This allows BIOS to skip certain tests while booting. This will decrease the time needed to boot the system.

Quiet Boot

When disabled, this displays normal POST messages. When enabled, this displays OEM Logo instead of POST messages.

AddOn ROM Display Mode

This allows user to force BIOS/Option ROM of add-on cards to be displayed during quiet boot.

Bootup Num-Lock

This select the power-on state for numlock.

PS/2 Mouse Support

This select support for PS/w mouse.

Wait for 'F1' If Error

When set to Enabled, the system waits for the F1 key to be pressed when error occurs. This allows option ROM to trap interrupt 19.

Hit Message Display

This displays "Press to run Setup" in POST.

Interrupt 19 Capture

This allows option ROMs to trap interrupt 19.

Security Settings

This setting comes with two options set the system password. Supervisor Password sets a password that will be used to protect the system and Setup utility. User Password sets a password that will be used exclusively on the system. To specify a password, highlight the type you want and press <Enter>. The Enter Password: message prompts on the screen. Type the password and press <Enter>. The system confirms your password by asking you to type it again. After setting a password, the screen automatically returns to the main screen.

To disable a password, just press the <Enter> key when you are prompted to enter the password. A message will confirm the password to be disabled. Once the password is disabled, the system will boot and you can enter Setup freely.

BIOS SETUP UTILITY						
Main	Advanced	PCIPnP	Boot	Security	Chipset	Exit
Security Settings				Install or Change the Password.		
Supervisor Password : Not Installed				<- Select Screen ↑↓ Select Item Enter Change F1 General Help F10 Save and Exit ESC Exit		
User Password : Not Installed						
Change Supervisor Password Change User Password						
Boot Sector Virus Protection [Disabled]						

Advanced Chipset Settings

This setting configures the north bridge, south bridge and the ME subsystem. **WARNING!** Setting the wrong values may cause the system to malfunction.

BIOS SETUP UTILITY

Main	Advanced	PCIPnP	Boot	Security	Chipset	Exit
Advanced Chipset Settings					Configure North Bridge features.	
<p>WARNING: Setting wrong values in below sections may cause system to malfunction.</p> <ul style="list-style-type: none"> ▶ North Bridge Configuration ▶ South Bridge Configuration 					<p><- Select Screen ↑↓ Select Item Enter Go to Sub Screen F1 General Help F10 Save and Exit ESC Exit</p>	

BIOS SETUP UTILITY

Chipset	
North Bridge Chipset Configuration	Options
<p>PCI MMIO Allocation: 4GB To 3072MB</p> <p>Configure DRAM Timing by SPD [Enabled]</p> <p>Initiate Graphics Adapter [IGD]</p> <p>Internal Graphics Mode Select[Enabled, 8MB]</p> <p>PEG Port Configuration</p> <ul style="list-style-type: none"> ▶ Video Function Configuration 	<p>Enabled Disabled</p> <p><- Select Screen ↑↓ Select Item Enter Go to Sub Screen F1 General Help F10 Save and Exit ESC Exit</p>

Configure DRAM Timing by SPD

When this item is enabled, the DRAM timing parameters are set according to the DRAM SPD (Serial Presence Detect). When disabled, you can manually set the DRAM timing parameters through the DRAM sub-items.

Initiate Graphic Adapter

Select which graphics controller to use as the primary boot device. This option, by default, is set to IGD.

Internal Graphics Mode Select

Use the feature to set the amount of system memory to be used by the Internal graphics device. expansion cards that require a specified area of memory to work properly.

BIOS SETUP UTILITY		Chipset
Video Function Configuration		Options
DVMT Mode Select	[DVMT Mode]	Fixed Mode
DVMT/FIXED Memory	[256MB]	DVMT Mode
Boot Display Device	[CRT]	<- Select Screen
Flat Panel Type	[1024x768]	↑↓ Select Item
Spread Spectrum Clock	[Disabled]	+ - Change Field
		F1 General Help
		F10 Save and Exit
		ESC Exit

DVMT Mode Select

Select the control mode of memory built-in graphics capabilities. This option, by default, is set to DVMT Mode.

DVMT/FIXED Memory

Sets the maximum memory size assigned to the integrated graphics capabilities. This option, by default, is set to 256MB.

Boot Display Device

This option is used to select the display device used by the system when it boots.

Flat Panel Type

This option is used to select the type of flat panel connected to the system.

Options include: 640x480 / 800x600 / 1024x768 / 1280x768 / 1280x800 / 1280x600.

Spread Spectrum Clock

By default, this field is set to *Disabled*.

BIOS SETUP UTILITY

Main	Advanced	PCI/PnP	Boot	Security	Chipset	Exit
South Bridge Chipset Configuration					Options	
USB Function					Disabled	
[8 USB Ports]					2 USB Ports	
USB 2.0 Controller		[Enabled]			4 USB Ports	
HAD Controller		[Enabled]			6 USB Ports	
SMBUS Controller		[Enabled]			8 USB Ports	
PCI Express Configuration					10 USB Ports	
PCI Express Port 0		[Auto]			<- Select Screen	
PCI Express Port 1		[Auto]			↑↓ Select Item	
PCI Express Port 2		[Auto]			+ - Change Field	
PCI Express Port 3		[Auto]			F1 General Help	
PCI Express Port 4		[Auto]			F10 Save and Exit	
PCI Express Port 5		[Disabled]			ESC Exit	
PCI Express High Priority Port		[Disabled]				
PCI Express Port 0 IOxAPIC Enable		[Disabled]				
PCI Express Port 1 IOxAPIC Enable		[Disabled]				
PCI Express Port 2 IOxAPIC Enable		[Disabled]				
PCI Express Port 3 IOxAPIC Enable		[Disabled]				
PCI Express Port 4 IOxAPIC Enable		[Disabled]				
PCI Express Port 5 IOxAPIC Enable		[Disabled]				
Enable Onboard PCI option ROM		[Disabled]				

USB Function

This option enables the number of USB ports desired or disables the USB function.

USB 2.0 Controller

This option is disabled by default.

HDA Controller

This option is used to enable the Southbridge high definition audio controller.

SMBUS Controller

This option is enabled by default.

Enable Onboard PCI option ROM

This option is disabled by default.

Exit Setup

The exit setup has the following settings which are:

BIOS SETUP UTILITY						
Main	Advanced	PCIPnP	Boot	Security	Chipset	Exit
Exit Options					Exit system setup after saving the changes.	
Save Changes and Exit Discard Changes and Exit Discard Changes Load Optimal Defaults Load Failsafe Defaults					F10 key can be used for this operation <- Select Screen ↑↓ Select Item Enter Go to Sub Screen F1 General Help F10 Save and Exit ESC Exit	

Save Changes and Exit

This option allows you to determine whether or not to accept the modifications and save all changes into the CMOS memory before exit.

Discard Changes and Exit

This option allows you to exit the Setup utility without saving the changes you have made in this session.

Discard Changes

This option allows you to discard all the changes that you have made in this session.

Load Optimal Defaults

This option allows you to load the default values to your system configuration. These default settings are optimal and enable all high performance features.

Load Failsafe Defaults

This option allows you to load the troubleshooting default values permanently stored in the BIOS ROM. These default settings are non-optimal and disable all high-performance features.

This page is intentionally left blank.

Drivers Installation

This section describes the installation procedures for software and drivers under the Windows XP, Windows Vista and Windows 7. The software and drivers are included with the motherboard. If you find the items missing, please contact the vendor where you made the purchase. The contents of this section include the following:

Intel Chipset Software Installation Utility	40
Intel Pineview Chipset Family Graphics Driver Installation	42
Realtek High Definition Codec Audio Driver Installation	44
Realtek RTL8111DL LAN Drivers Installation	45

IMPORTANT NOTE:

After installing your Windows operating system (Windows XP/ Vista/ 7), you must install first the Intel Chipset Software Installation Utility before proceeding with the drivers installation.

Intel Chipset Software Installation Utility

The Intel Chipset Drivers should be installed first before the software drivers to enable Plug & Play INF support for Intel chipset components. Follow the instructions below to complete the installation under Windows XP/Vista/7.

1. Insert the drivers DVD into the DVD drive. Click **Intel** and then **Intel(R) Pineview Chipset Drivers**. Click **Intel(R) Chipset Software Installation Utility**.

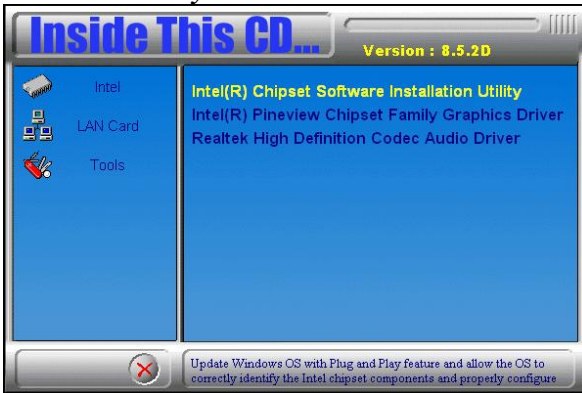

2. When the welcome screen to the Intel(R) Chipset Software Installation Utility appears, click **Next** to continue.



3. Click **Yes** to accept the software license agreement and proceed with the installation process.
4. On the Readme Information screen, click **Next** to continue. When the Setup Progress screen appears, click **Next** to continue.



5. The Setup process is now complete. Click **Finish** to restart the computer and for changes to take effect.



Intel Pineview Chipset Family Graphics Driver Installation

To install the VGA drivers, follow the steps below to proceed with the installation.

1. Insert the drivers DVD into the DVD drive. Click **Intel** and then **Intel(R) Pineview Chipset Drivers**. Click **Intel(R) Pineview Chipset Family Graphics Driver**.

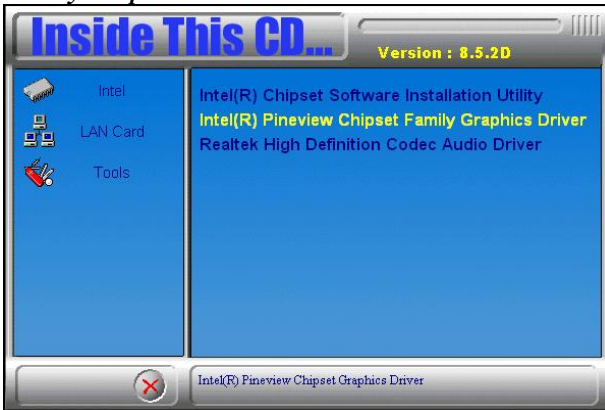

2. When the welcome screen of the Intel(R) Graphics Media Accelerator Driver appears, click **Next** to continue.



3. Click **Yes** to agree with the license agreement and continue the installation.

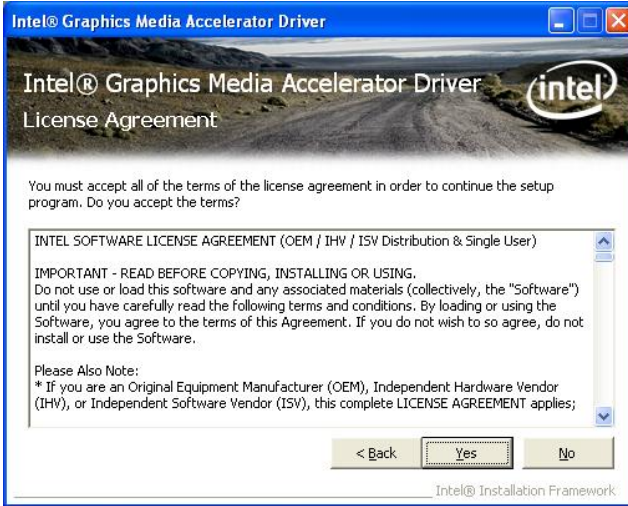

4. Click **Next** in the Readme File Information window.

5. Click **Next** in the Setup Progress window.

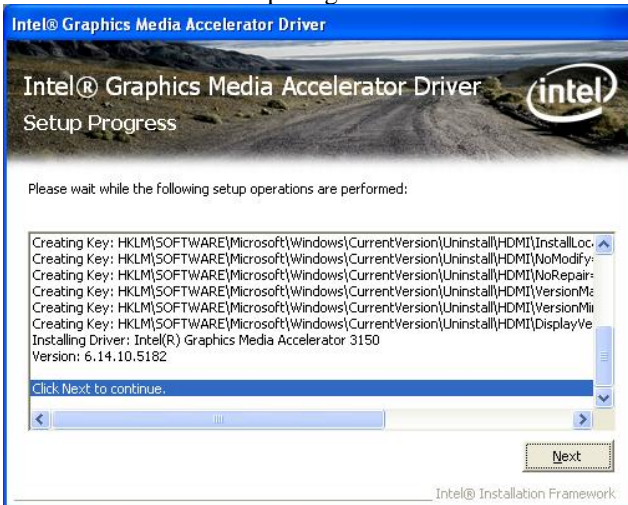

6. Setup is now complete. Click **Finish** to restart the computer and for changes to take effect.

Realtek High Definition Codec Audio Driver Installation

Follow the steps below to install the Realtek HD Codec Audio Drivers.

1. Insert the drivers DVD into the DVD drive. Click **Intel** and then **Intel(R) Pineview Chipset Drivers**. Click **Realtek High Definition Codec Audio Driver**.

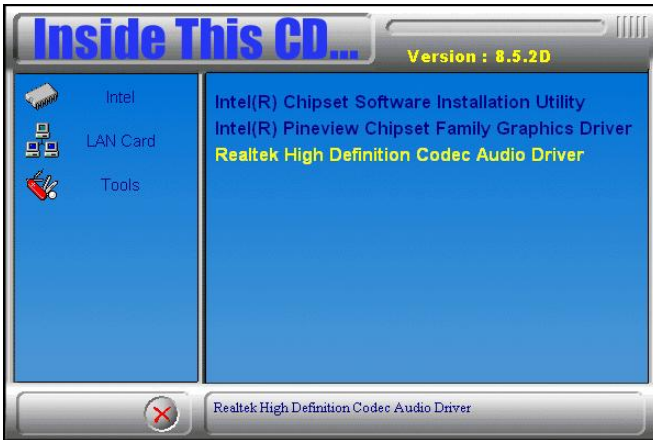

2. When the welcome screen to InstallShield Wizard for **Realtek High Definition Audio Driver** appears, click **Next** to start the installation.

3. When the InstallShield Wizard has finished performing maintenance operations on Realtek High Definition Codec Audio Driver, click **Finish** to restart the computer.

Realtek RTL811DL LAN Drivers Installation

Follow the steps below to install Realtek RTL811DL LAN Drivers.

1. Insert the drivers DVD into the DVD drive. Click **LAN Card** and then **Realtek LAN Controller Drivers**. Click **Realtek RTL811DL LAN Drivers**.



2. In the welcome screen of the InstallShield Wizard for REALTEK GbE & FE Ethernet PCI-E NIC Driver, click **Next**.

3. In the InstallShield Wizard screen, click **Install** to begin the installation.

4. InstallShield Wizard completed. Click **Finish** to exit the Wizard.

This page is intentionally left blank.

Appendix

A. I/O Port Address Map

Each peripheral device in the system is assigned a set of I/O port addresses that also becomes the identity of the device. The following table lists the I/O port addresses used.

Address	Device Description
000h - 01Fh	DMA Controller #1
020h - 03Fh	Interrupt Controller #1
040h - 05Fh	Timer
060h - 06Fh	Keyboard Controller
070h - 07Fh	Real Time Clock, NMI
080h - 09Fh	DMA Page Register
0A0h - 0BFh	Interrupt Controller #2
0C0h - 0DFh	DMA Controller #2
0F0h	Clear Math Coprocessor Busy Signal
0F1h	Reset Math Coprocessor
1F0h - 1F7h	IDE Interface
2B0h - 2DFh	Graphics adapter Controller
2E8h - 2EFh	Serial Port #4(COM4)
2F8h - 2FFh	Serial Port #2(COM2)
360h - 36Fh	Network Ports
3B0h - 3BFh	Monochrome & Printer adapter
3C0h - 3CFh	EGA adapter
3D0h - 3DFh	CGA adapter
3E8h - 3EFh	Serial Port #3(COM3)
3F8h - 3FFh	Serial Port #1(COM1)

B. Interrupt Request Lines (IRQ)

Peripheral devices use interrupt request lines to notify CPU for the service required. The following table shows the IRQ used by the devices on board.

Level	Function
IRQ0	System Timer Output
IRQ1	Keyboard
IRQ2	Interrupt Cascade
IRQ3	Serial Port #2
IRQ4	Serial Port #1
IRQ5	Reserved
IRQ6	Reserved
IRQ7	Reserved
IRQ8	Real Time Clock
IRQ9	Reserved
IRQ10	Serial Port #4
IRQ11	Serial Port #3
IRQ12	PS/2 Mouse
IRQ13	80287
IRQ14	Primary IDE

C. Watchdog Timer Configuration

The WDT is used to generate a variety of output signals after a user programmable count. The WDT is suitable for use in the prevention of system lock-up, such as when software becomes trapped in a deadlock. Under these sorts of circumstances, the timer will count to zero and the selected outputs will be driven. Under normal circumstance, the user will restart the WDT at regular intervals before the timer counts to zero.

SAMPLE CODE:

```
File of the W627UHG.CPP
//-----
//
// THIS CODE AND INFORMATION IS PROVIDED "AS IS" WITHOUT WARRANTY OF ANY
// KIND, EITHER EXPRESSED OR IMPLIED, INCLUDING BUT NOT LIMITED TO THE
// IMPLIED WARRANTIES OF MERCHANTABILITY AND/OR FITNESS FOR A PARTICULAR
// PURPOSE.
//
//-----
#include "W627UHG.H"
#include <dos.h>
//-----
unsigned int W627UHG_BASE;
void Unlock_W627UHG (void);
void Lock_W627UHG (void);
//-----
unsigned int Init_W627UHG(void)
{
    unsigned int result;
    unsigned char ucDid;

    W627UHG_BASE = 0x4E;
    result = W627UHG_BASE;

    ucDid = Get_W627UHG_Reg(0x20);
    if (ucDid == 0xA2)                                //W83627UHG??
    {
        goto Init_Finish;
    }

    W627UHG_BASE = 0x2E;
    result = W627UHG_BASE;

    ucDid = Get_W627UHG_Reg(0x20);
    if (ucDid == 0xA2)                                //W83627UHG??
    {
        goto Init_Finish;
    }

    W627UHG_BASE = 0x00;
    result = W627UHG_BASE;

Init_Finish:
    return (result);
}
//-----
void Unlock_W627UHG (void)
```

```
{
    outportb(W627UHG_INDEX_PORT, W627UHG_UNLOCK);
    outportb(W627UHG_INDEX_PORT, W627UHG_UNLOCK);
}
//-----
void Lock_W627UHG (void)
{
    outportb(W627UHG_INDEX_PORT, W627UHG_LOCK);
}
//-----
void Set_W627UHG_LD( unsigned char LD)
{
    Unlock_W627UHG();
    outportb(W627UHG_INDEX_PORT, W627UHG_REG_LD);
    outportb(W627UHG_DATA_PORT, LD);
    Lock_W627UHG();
}
//-----
void Set_W627UHG_Reg( unsigned char REG, unsigned char DATA)
{
    Unlock_W627UHG();
    outportb(W627UHG_INDEX_PORT, REG);
    outportb(W627UHG_DATA_PORT, DATA);
    Lock_W627UHG();
}
//-----
unsigned char Get_W627UHG_Reg(unsigned char REG)
{
    unsigned char Result;
    Unlock_W627UHG();
    outportb(W627UHG_INDEX_PORT, REG);
    Result = inportb(W627UHG_DATA_PORT);
    Lock_W627UHG();
    return Result;
}
//-----
```

File of the W627UHG.H

```
//-----  
//  
// THIS CODE AND INFORMATION IS PROVIDED "AS IS" WITHOUT WARRANTY OF ANY  
// KIND, EITHER EXPRESSED OR IMPLIED, INCLUDING BUT NOT LIMITED TO THE  
// IMPLIED WARRANTIES OF MERCHANTABILITY AND/OR FITNESS FOR A PARTICULAR  
// PURPOSE.  
//  
//-----  
#ifndef __W627UHG_H  
#define __W627UHG_H          1  
//-----  
#define W627UHG_INDEX_PORT (W627UHG_BASE)  
#define W627UHG_DATA_PORT  (W627UHG_BASE+1)  
//-----  
#define W627UHG_REG_LD      0x07  
//-----  
#define W627UHG_UNLOCK     0x87  
#define W627UHG_LOCK       0xAA  
//-----  
unsigned int Init_W627UHG(void);  
void Set_W627UHG_LD( unsigned char);  
void Set_W627UHG_Reg( unsigned char, unsigned char);  
unsigned char Get_W627UHG_Reg( unsigned char);  
//-----  
#endif    // __W627UHG_H
```

APPENDIX

File of the MAIN.CPP

```
//-----  
//  
// THIS CODE AND INFORMATION IS PROVIDED "AS IS" WITHOUT WARRANTY OF ANY  
// KIND, EITHER EXPRESSED OR IMPLIED, INCLUDING BUT NOT LIMITED TO THE  
// IMPLIED WARRANTIES OF MERCHANTABILITY AND/OR FITNESS FOR A PARTICULAR  
// PURPOSE.  
//  
//-----  
#include <dos.h>  
#include <conio.h>  
#include <stdio.h>  
#include <stdlib.h>  
#include "W627UHG.H"  
//-----  
int main (void);  
  
void WDTInitial(void);  
void WDTEnable(unsigned char);  
void WDTDisable(void);  
  
//-----  
int main (void)  
{  
    char SIO;  
  
    SIO = Init_W627UHG();  
    if (SIO == 0)  
    {  
        .....printf("Can not detect Winbond 83627UHG, program abort.\n");  
        ..... return(1);  
    }  
  
    WDTInitial();  
  
    WDTEnable(10);  
  
    WDTDisable();  
  
    return 0;  
}  
//-----  
void WDTInitial(void)  
{  
    unsigned char bBuf;  
    Set_W627UHG_LD(0x08);.....//switch to logic device 8  
    bBuf = Get_W627UHG_Reg(0x30);  
    bBuf &= (~0x01);  
    Set_W627UHG_Reg(0x30, bBuf);.....//Enable WDTO  
}  
//-----  
void WDTEnable(unsigned char NewInterval)  
{  
    unsigned char bBuf;  
  
    Set_W627UHG_LD(0x08);.....  
    Set_W627UHG_Reg(0x30, 0x01); .....//enable timer
```

```
bBuf = Get_W627UHG_Reg(0xF5);
bBuf &= (~0x08);
Set_W627UHG_Reg(0xF5, bBuf);.....//count mode is second

Set_W627UHG_Reg(0xF6, NewInterval);.....//set timer
}
//-----
void WDTDisable(void)
{
    Set_W627UHG_LD(0x08);.....
    Set_W627UHG_Reg(0xF6, 0x00);.....//clear watchdog timer
    Set_W627UHG_Reg(0x30, 0x00);.....
}
//-----
```

D. Digital I/O Sample Code

File of the W627UHG.H

```
//-----  
//  
// THIS CODE AND INFORMATION IS PROVIDED "AS IS" WITHOUT WARRANTY OF ANY  
// KIND, EITHER EXPRESSED OR IMPLIED, INCLUDING BUT NOT LIMITED TO THE  
// IMPLIED WARRANTIES OF MERCHANTABILITY AND/OR FITNESS FOR A PARTICULAR  
// PURPOSE.  
//  
//-----  
#ifndef __W627UHG_H  
#define __W627UHG_H 1  
//-----  
#define W627UHG_INDEX_PORT (W627UHG_BASE)  
#define W627UHG_DATA_PORT (W627UHG_BASE+1)  
//-----  
#define W627UHG_REG_LD 0x07  
//-----  
#define W627UHG_UNLOCK 0x87  
#define W627UHG_LOCK 0xAA  
//-----  
unsigned int Init_W627UHG(void);  
void Set_W627UHG_LD( unsigned char);  
void Set_W627UHG_Reg( unsigned char, unsigned char);  
unsigned char Get_W627UHG_Reg( unsigned char);  
//-----  
#endif // __W627UHG_H
```

File of the W627UHG.CPP

```
//-----
//
// THIS CODE AND INFORMATION IS PROVIDED "AS IS" WITHOUT WARRANTY OF ANY
// KIND, EITHER EXPRESSED OR IMPLIED, INCLUDING BUT NOT LIMITED TO THE
// IMPLIED WARRANTIES OF MERCHANTABILITY AND/OR FITNESS FOR A PARTICULAR
// PURPOSE.
//
//-----
#include "W627UHG.H"
#include <dos.h>
//-----
unsigned int W627UHG_BASE;
void Unlock_W627UHG (void);
void Lock_W627UHG (void);
//-----
unsigned int Init_W627UHG(void)
{
    unsigned int result;
    unsigned char ucDid;

    W627UHG_BASE = 0x4E;
    result = W627UHG_BASE;

    ucDid = Get_W627UHG_Reg(0x20);
    if (ucDid == 0xA2)                                //W83627UHG??
    {
        goto Init_Finish;
    }

    W627UHG_BASE = 0x2E;
    result = W627UHG_BASE;

    ucDid = Get_W627UHG_Reg(0x20);
    if (ucDid == 0xA2)                                //W83627UHG??
    {
        goto Init_Finish;
    }

    W627UHG_BASE = 0x00;
    result = W627UHG_BASE;

Init_Finish:
    return (result);
}
//-----
void Unlock_W627UHG (void)
{
    outportb(W627UHG_INDEX_PORT, W627UHG_UNLOCK);
    outportb(W627UHG_INDEX_PORT, W627UHG_UNLOCK);
}
//-----
void Lock_W627UHG (void)
{
    outportb(W627UHG_INDEX_PORT, W627UHG_LOCK);
}
//-----
void Set_W627UHG_LD( unsigned char LD)
```

```
{
    Unlock_W627UHG();
    outportb(W627UHG_INDEX_PORT, W627UHG_REG_LD);
    outportb(W627UHG_DATA_PORT, LD);
    Lock_W627UHG();
}
//-----
void Set_W627UHG_Reg( unsigned char REG, unsigned char DATA)
{
    Unlock_W627UHG();
    outportb(W627UHG_INDEX_PORT, REG);
    outportb(W627UHG_DATA_PORT, DATA);
    Lock_W627UHG();
}
//-----
unsigned char Get_W627UHG_Reg(unsigned char REG)
{
    unsigned char Result;
    Unlock_W627UHG();
    outportb(W627UHG_INDEX_PORT, REG);
    Result = inportb(W627UHG_DATA_PORT);
    Lock_W627UHG();
    return Result;
}
//-----
```

File of the MAIN.CPP

```
//-----
//
// THIS CODE AND INFORMATION IS PROVIDED "AS IS" WITHOUT WARRANTY OF ANY
// KIND, EITHER EXPRESSED OR IMPLIED, INCLUDING BUT NOT LIMITED TO THE
// IMPLIED WARRANTIES OF MERCHANTABILITY AND/OR FITNESS FOR A PARTICULAR
// PURPOSE.
//
//-----
#include <dos.h>
#include <conio.h>
#include <stdio.h>
#include <stdlib.h>
#include "W627UHG.H"
//-----
int main (void);

void Dio5Initial(void);
void Dio5SetOutput(unsigned char);
unsigned char Dio5GetInput(void);
void Dio5SetDirection(unsigned char);
unsigned char Dio5GetDirection(void);
//-----
int main (void)
{
    char SIO;

    SIO = Init_W627UHG();
    if (SIO == 0)
    {
        printf("Can not detect Winbond 83627UHG, program abort.\n");
        return(1);
    }

    Dio5Initial();

    //for GPIO50..57
    Dio5SetDirection(0x0F);//GP50..53 = input, GP54..57=output
    printf("Current DIO direction = 0x%X\n", Dio5GetDirection());

    printf("Current DIO status = 0x%X\n", Dio5GetInput());

    printf("Set DIO output to high\n");
    Dio5SetOutput(0x0F);

    printf("Set DIO output to low\n");
    Dio5SetOutput(0x00);

    return 0;
}
```

```
}
//-----
void Dio5Initial(void)
{
    unsigned char ucBuf;

    Set_W627UHG_LD(0x08); //switch to logic device 8
    //enable the GP5 group
    ucBuf = Get_W627UHG_Reg(0x30);
    ucBuf |= 0x02;
    Set_W627UHG_Reg(0x30, ucBuf);
}
//-----
void Dio5SetOutput(unsigned char NewData)
{
    Set_W627UHG_LD(0x08); //switch to logic device 8
    Set_W627UHG_Reg(0xE1, NewData);
}
//-----
unsigned char Dio5GetInput(void)
{
    unsigned char result;

    Set_W627UHG_LD(0x08); //switch to logic device 8
    result = Get_W627UHG_Reg(0xE1);
    return (result);
}
//-----
void Dio5SetDirection(unsigned char NewData)
{
    //NewData : 1 for input, 0 for output
    Set_W627UHG_LD(0x08); //switch to logic device 8
    Set_W627UHG_Reg(0xE0, NewData);
}
//-----
unsigned char Dio5GetDirection(void)
{
    unsigned char result;

    Set_W627UHG_LD(0x08); //switch to logic device 8
    result = Get_W627UHG_Reg(0xE0);
    return (result);
}
//-----
```