

# **IB805**

Intel® Atom 945GSE  
PC/104-Plus CPU Module

## **USER'S MANUAL**

Version 1.0

---

## Acknowledgments

Award is a registered trademark of Award Software International, Inc.

PS/2 is a trademark of International Business Machines Corporation.

Intel® and Atom™ are registered trademarks of Intel Corporation.

Microsoft Windows is a registered trademark of Microsoft Corporation.

Winbond is a registered trademark of Winbond Electronics Corporation.

All other product names or trademarks are properties of their respective owners.

---

Table of Contents

**Introduction ..... 1**

- Product Description..... 1
- Checklist..... 2
- Specifications ..... 3
- Board Dimensions ..... 4

**Installations ..... 5**

- Installing the Memory (SODIMM) ..... 6
- Jumpers and Connector on IB805 ..... 7

**BIOS Setup ..... 15**

**Drivers Installation ..... 37**

- Intel Chipset Software Installation Utility..... 38
- Intel Graphics Driver Installation..... 39
- Realtek HD Codec Audio Driver Installation ..... 40
- Intel PRO LAN Drivers Installation..... 42

**Appendix ..... 47**

- A. I/O Port Address Map..... 47
- B. Interrupt Request Lines (IRQ) ..... 48
- C. Watchdog Timer Configuration..... 49

---

This page is intentionally left blank.

# Introduction

## Product Description

---

---

The IB805 PCI-104+ SBC is a small footprint single board computer that is configured with the Intel Atom processor N270 at 1.6GHz, FSB533 and the Mobile Intel 945GSE Express Chipset with the ICH7M.

This PCI-104+ board provides greater flexibility for developers of embedded computing solutions. It is ideally suited for rugged and compact designs as in Internet devices and applications in automation, industrial control, data acquisition, thin client and other embedded PC applications.

IB805 features the Intel's Graphics Media Accelerator 950 core, making it compatible with Windows Vista Premium, and support display interfaces including VGA CRT and single channel 18-bit LVDS displays. One DDR2 SO-DIMM on board implements up to 1GB of system memory. One Gigabit LAN, with Intel 82574L controller, is also available.

Advanced connectivity and expansion interfaces include two SATA, two RS-232 serial ports and four USB 2.0 high-speed ports.

*Remarks: In installing the PC/104 Plus CPU board into a chassis, it is recommended that the CPU board be placed on the topmost level of the PC/104 board layers. The chassis environment should be designed in such a way that there is good airflow to ventilate the system.*

## **Checklist**

---

Your IB805 package should include the items listed below. Damaged or missing items should be reported to your supplier.

- The IB805 CPU Module
- This User's Manual
- One Driver CD
- Optional cable kit (PS2 keyboard/mouse, VGA, USB, COM, SATA, Audio)

## Specifications

<b>Product Name</b>	IB805
<b>Form Factor</b>	PCI 104+ SBC
<b>CPU Type</b>	Intel® Atom™ processor N270 (code name Diamondville SC processor)
<b>CPU Operating Frequency</b>	CPU Clock speed = 1.60GHz FSB=533MHz L2 Cache=512K TDP=2.5W
<b>Green /APM</b>	APM1.2
<b>BIOS</b>	Award BIOS: supports ACPI Function
<b>Chipset</b>	Intel® 945GSE Chipset GMCH: QG82945GSE 27 mm x 27 mm -998-pin FCBGA ICH7M: NH82801GBM 31mm x 31mm -652-pin BGA
<b>Memory</b>	DDRII 533 SO-DIMM x 1 (w/o ECC function), single channel. Max. 1GB
<b>VGA</b>	Intel® 945GSE built-in Graphics Media Accelerator 950 Graphics Core -----Supports CRT w/ DF13 connector & 18 bits single channels LVDS interface w/ DF13 socket
<b>LAN</b>	Intel® 82574L Gigabit Ethernet Controller x 1
<b>USB :</b>	ICH7M built-in USB 2.0 host controller, support 4 ports
<b>Serial ATA Ports</b>	ICH7M built-in SATA controller, supports 2 ports
<b>Audio</b>	Intel ICH7M built-in audio controller w/ Realtek ALC662 Codec supports 5.1-channel audio (Line-out, Line-in & MIC )
<b>IDE</b>	N/A
<b>LPC I/O</b>	Winbond® 83627EHG: - COM1 (RS232), COM2 (RS232), - Keyboard/Mouse Pin-header - Hardware monitor (3 thermal inputs, 6 voltage monitor inputs)
<b>RTC/CMOS</b>	ICH7M built-in with on board Lithium battery
<b>Expansion Slot</b>	PCI 104 plus (PCI only, No ISA support)
<b>Onboard Header / Connectors</b>	DF13 socket x1 for LVDS 2x5 pin header x 1 for VGA SATA connector x 2 ports 2x6 pin header x 1 for Audio 2x8 pin header x1 for Gigabit LAN port 2x4 pin header x2 for 4 USB ports (One pin-header is 90 degree) 2x5 pin header x2 for COM1/COM2 (90 degree) 1x6 pin header x1 for PS2 KB/MS
<b>Power Connector</b>	4 pin DC power connector x1 (+5V, +12V)
<b>Digital I/O</b>	N/A
<b>Watchdog Timer</b>	Yes (256 segments, 0, 1, 2...255. sec/min)
<b>RoHS Compliant</b>	Yes
<b>Board Size</b>	96 x 90mm (3.78" x 3.54")

# Board Dimensions

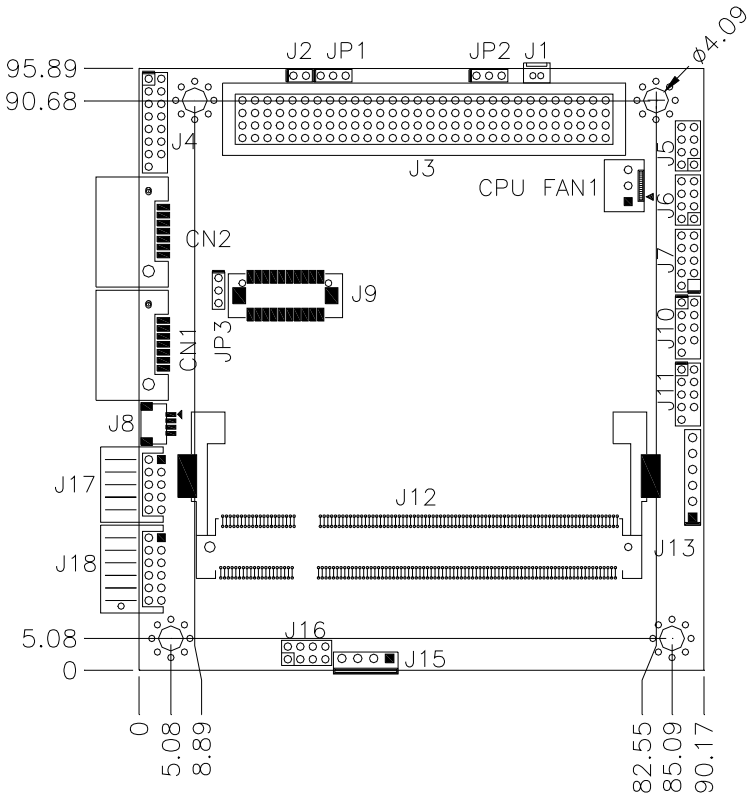

## Installations

This section provides information on how to use the jumpers and connectors on the IB805 in order to set up a workable system. The topics covered are:

Installing the Memory (SODIMM) .....	6
Jumpers and Connector on IB805 .....	7

## Installing the Memory (SODIMM)

---

The IB805 CPU board supports one DDR2 memory socket that can support up to 1GB memory, DDR2 400/533 (w/o ECC function).

### Installing and Removing Memory Modules

To install the DDR2 modules, locate the memory slot on the board and perform the following steps:

1. Hold the DDR2 module so that the key of the DDR2 module aligns with that on the memory slot. Insert the module into the socket at a slight angle (approximately 30 degrees). Note that the socket and module are both keyed, which means that the module can be installed only in one direction.
2. To seat the memory module into the socket, apply firm and even pressure to each end of the module until you feel it slip down into the socket.
3. With the module properly seated in the socket, rotate the module downward. Continue pressing downward until the clips at each end lock into position.
4. To remove the DDR2 module, press the clips with both hands.

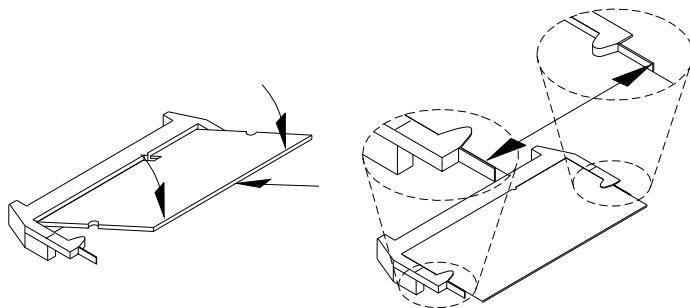

## Jumpers and Connector on IB805

---

Jumpers are used on the IB805 to select various settings and features according to your needs and applications. Contact your supplier if you have doubts about the best configuration for your needs. The following lists the connectors on IB805 and their respective functions.

Jumper and Connector Locations on IB805 .....	8
PC/104-Plus Bus Signal Assignments .....	9
JP1: AT & ATX Mode Selection .....	10
JP2: Clear CMOS Content.....	10
JP3: Panel Power Setting.....	10
CN1 CN2 :SATA1/SATA2 Connector .....	11
J2: Buzzer Connector .....	11
J3: PC/104+ PCI Connector .....	11
J4: LAN Connector.....	11
J5, J6: USB Connector .....	11
J7: SPI Flash Connector (factory use only).....	12
J8: LCD Backlight Connector (DC type) .....	12
J9: LVDS Connector .....	12
J11, J10: COM1 and COM2 Connectors.....	12
J13: Keyboard/Mouse Connector .....	12
J15: Power Connector.....	13
J16: Front I/O Connector.....	13
J17: CRT VGA Connector (DF11).....	13
J18: Audio Connector (DF11).....	13

**Jumper and Connector Locations on IB805**

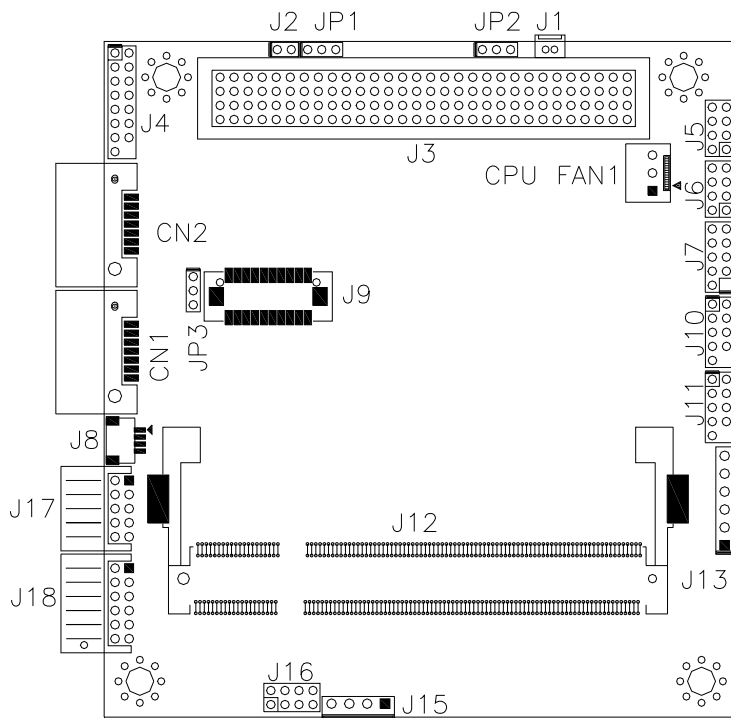

Jumper and Connectors on IB805 .....	Page
Jumper and Connector Locations on IB805.....	8
PC/104-Plus Bus Signal Assignments .....	9
JP1: AT & ATX Mode Selection .....	10
JP2: Clear CMOS Content .....	10
JP3: Panel Power Setting.....	10
CN1 CN2 :SATA1/SATA2 Connector.....	11
J2: Buzzer Connector .....	11
J3: PC/104+ PCI Connector.....	11
J4: LAN Connector .....	11
J5, J6: USB Connector .....	11
J7: SPI Flash Connector (factory use only).....	12
J8: LCD Backlight Connector (DC type).....	12
J9: LVDS Connector .....	12
J11, J10: COM1 and COM2 Connectors .....	12
J13: Keyboard/Mouse Connector.....	12
J15: Power Connector .....	13
J16: Front I/O Connector.....	13
J17: CRT VGA Connector (DF11) .....	13
J18: Audio Connector (DF11).....	13

## PC/104-Plus Bus Signal Assignments

J3/P3				
Pin	A	B	C	D
1	GND/5.0V KEY <sup>2</sup>	Reserved	+5	AD00
2	VI/O	AD02	AD01	+5V
3	AD05	GND	AD04	AD03
4	C/BE0*	AD07	GND	AD06
5	GND	AD09	AD08	GND
6	AD11	VI/O	AD10	M66EN
7	AD14	AD13	GND	AD12
8	+3.3V	C/BE1*	AD15	+3.3V
9	SERR*	GND	SB0*	PAR
10	GND	PERR*	+3.3V	SDONE
11	STOP*	+3.3V	LOCK*	GND
12	+3.3V	TRDY*	GND	DEVSEL*
13	FRAME*	GND	IRDY*	+3.3V
14	GND	AD16	+3.3V	C/BE2*
15	AD18	+3.3V	AD17	GND
16	AD21	AD20	GND	AD19
17	+3.3V	AD23	AD22	+3.3V
18	IDSEL0	GND	IDSEL1	IDSEL2
19	AD24	C/BE3*	VI/O	IDSEL3
20	GND	AD26	AD25	GND
21	AD29	+5V	AD28	AD27
22	+5V	AD30	GND	AD31
23	REQ0*	GND	REQ1*	VI/O
24	GND	REQ2*	+5V	GNT0*
25	GNT1*	VI/O	GNT2*	GND
26	+5V	CLK0	GND	CLK1
27	CLK2	+5V	CLK3	GND
28	GND	INTD*	+5V	RST*
29	+12V	INTA*	INTB*	INTC*
30	-12V	Reserved	Reserved	GND/3.3V KEY <sup>2</sup>

\* The shaded area denotes power or ground signals.

\* The KEY pins are to guarantee proper module installation. Pin-A1 will be removed and the female side plugged for 5.0V I/O signals and Pin-D30 will be modified in the same manner for 3.3V I/O. It is recommended that both KEY pins (A1 and D30) be electrically connected for GND for shielding.

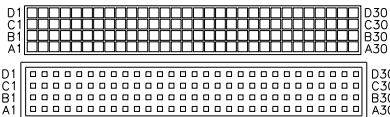

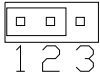
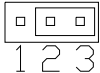

**JP1: AT & ATX Mode Selection**

JP1	Setting	Power Mode
 1 2 3	Pin 1-2 Short/Closed	AT
 1 2 3	Pin 2-3 Short/Closed	ATX (default)

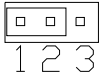
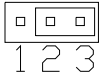
**JP2: Clear CMOS Content**

JP2	Setting	Function
 1 2 3	Pin 1-2 Short/Closed	Normal Operation
 1 2 3	Pin 2-3 Short/Closed	Clear CMOS Content

**JP3: Panel Power Setting**

JP3	Setting	Function
 1 2 3	Pin 1-2 Short/Closed	+3.3V
 1 2 3	Pin 2-3 Short/Closed	+5V

**CN1 CN2 :SATA1/SATA2 Connector**

Pin #	Signal Name
1	Ground
2	TX+
3	TX-
4	Ground
5	RX-
6	RX+
7	Ground

**J2: Buzzer Connector**



Pin#	Signal Name
1	Buzzer+
2	Buzzer-

**J3: PC/104+ PCI Connector**

**J4: LAN Connector**

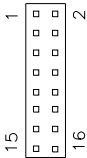

Signal Name	Pin #	Pin #	Signal Name
MX4-	1	2	Link 1000
MX4+	3	4	NC
MX3-	5	6	Link ACT
MX3+	7	8	Link LED+
MX2-	9	10	Link 100
MX2+	11	12	Link LED+
MX1-	13	14	Link LED+
MX1+	15	16	NC

**J5, J6: USB Connector**

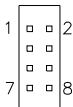

Signal Name	Pin #	Pin #	Signal Name
USB Power	1	2	Ground
D-	3	4	D+
D+	5	6	D-
Ground	7	8	USB Power

**J7: SPI Flash Connector (factory use only)**

**J8: LCD Backlight Connector (DC type)**

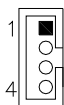

Pin #	Signal Name
1	+12V
2	Backlight Enable
3	*Backlight Adj (DC type)
4	Ground

**J9: LVDS Connector**

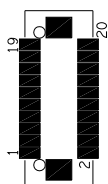

Signal Name	Pin #	Pin #	Signal Name
TX0-	2	1	TX0+
Ground	4	3	Ground
TX1-	6	5	TX1+
5V/3.3V	8	7	Ground
TX3-	10	9	TX3+
TX2-	12	11	TX2+
Ground	14	13	Ground
TXC-	16	15	TXC+
5V/3.3V	18	17	ENABKL
+12V	20	19	+12V

**J11, J10: COM1 and COM2 Connectors**

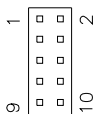

Signal Name	Pin #	Pin #	Signal Name
Data carrier detect	1	2	Data set ready
Receive data	3	4	Request to send
Transmit data	5	6	Clear to send
Data terminal ready	7	8	Ring indicator
Ground	9	10	No connect.

**J13: Keyboard/Mouse Connector**

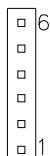

Pin #	Signal Name
1	Keyboard Data
2	Keyboard Clock
3	Mouse Data
4	Mouse Clock
5	Ground
6	Vcc

**J15: Power Connector**



Pin #	Signal Name
1	Vcc
2	Ground
3	Ground
4	+12V

**J16: Front I/O Connector**

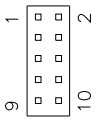

Signal Name	Pin #	Pin #	Signal Name
PS_SW-	1	2	PS_SW +
Power LED+	3	4	Power LED-
HDD LED+	5	6	HDD LED-
Reset-	7	8	Reset+

**J17: CRT VGA Connector (DF11)**

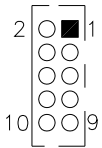

Signal Name	Pin	Pin	Signal Name
GND	2	1	Red
HSYNC	4	3	Green
VSYNC	6	5	Blue
GND	8	7	GND
SPCLK	10	9	SPDATA

**J18: Audio Connector (DF11)**

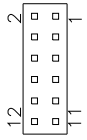

Signal Name	Pin #	Pin #	Signal Name
LINEOUT R	2	1	LINEOUT L
Ground	4	3	LINEOUT Detect
LINEIN R	6	5	LINEIN L
Ground	8	7	LINEIN Detect
VREFOUT	10	9	MIC1
Ground	12	11	MIC1 Detect

This page is intentionally left blank.

---

# BIOS Setup

This chapter describes the different settings available in the Award BIOS that comes with the board. The topics covered in this chapter are as follows:

BIOS Introduction .....	16
BIOS Setup.....	16
Standard CMOS Setup .....	18
Advanced BIOS Features .....	21
Advanced Chipset Features .....	24
Integrated Peripherals.....	27
Power Management Setup.....	30
PNP/PCI Configurations .....	33
PC Health Status.....	34
Frequency/Voltage Control .....	35
Load Fail-Safe Defaults.....	36
Load Optimized Defaults .....	36
Set Supervisor/User Password.....	36
Save & Exit Setup .....	36
Exit Without Saving .....	36

## BIOS Introduction

The Award BIOS (Basic Input/Output System) installed in your computer system's ROM supports Intel processors. The BIOS provides critical low-level support for a standard device such as disk drives, serial ports and parallel ports. It also adds virus and password protection as well as special support for detailed fine-tuning of the chipset controlling the entire system.

## BIOS Setup

The Award BIOS provides a Setup utility program for specifying the system configurations and settings. The BIOS ROM of the system stores the Setup utility. When you turn on the computer, the Award BIOS is immediately activated. Pressing the <Del> key immediately allows you to enter the Setup utility. If you are a little bit late pressing the <Del> key, POST (Power On Self Test) will continue with its test routines, thus preventing you from invoking the Setup. If you still wish to enter Setup, restart the system by pressing the "Reset" button or simultaneously pressing the <Ctrl>, <Alt> and <Delete> keys. You can also restart by turning the system Off and back On again. The following message will appear on the screen:

```
Press <DEL> to Enter Setup
```

In general, you press the arrow keys to highlight items, <Enter> to select, the <PgUp> and <PgDn> keys to change entries, <F1> for help and <Esc> to quit.

When you enter the Setup utility, the Main Menu screen will appear on the screen. The Main Menu allows you to select from various setup functions and exit choices.

## Phoenix - AwardBIOS CMOS Setup Utility

Standard CMOS Features	Frequency/Voltage Control
Advanced BIOS Features	Load Fail-Safe Defaults
Advanced Chipset Features	Load Optimized Defaults
Integrated Peripherals	Set Supervisor Password
Power Management Setup	Set User Password
PnP/PCI Configurations	Save & Exit Setup
PC Health Status	Exit Without Saving
ESC : Quit	↑ ↓ → ← : Select Item
F10 : Save & Exit Setup	
Time, Date, Hard Disk Type...	

The section below the setup items of the Main Menu displays the control keys for this menu. At the bottom of the Main Menu just below the control keys section, there is another section, which displays information on the currently highlighted item in the list.

**Note:** *If the system cannot boot after making and saving system changes with Setup, the Award BIOS supports an override to the CMOS settings that resets your system to its default.*

**Warning:** *It is strongly recommended that you avoid making any changes to the chipset defaults. These defaults have been carefully chosen by both Award and your system manufacturer to provide the absolute maximum performance and reliability. Changing the defaults could cause the system to become unstable and crash in some cases.*

## Standard CMOS Setup

“Standard CMOS Setup” choice allows you to record some basic hardware configurations in your computer system and set the system clock and error handling. If the board is already installed in a working system, you will not need to select this option. You will need to run the Standard CMOS option, however, if you change your system hardware configurations, the onboard battery fails, or the configuration stored in the CMOS memory was lost or damaged.

Phoenix - AwardBIOS CMOS Setup Utility  
Standard CMOS Features

Date (mm:dd:yy)	Wed, Apr 28, 2004	Item Help
Time (hh:mm:ss)	00 : 00 : 00	Menu Level >
IDE Channel 0 Master	None	Change the day, month, Year and century
IDE Channel 0 Slave	None	
IDE Channel 1 Master	None	
IDE Channel 1 Slave	None	
Video	EGA/VGA	
Halt On	All, But Keyboard	
Base Memory	640K	
Extended Memory	129024K	
Total Memory	130048K	

At the bottom of the menu are the control keys for use on this menu. If you need any help in each item field, you can press the <F1> key. It will display the relevant information to help you. The memory display at the lower right-hand side of the menu is read-only. It will adjust automatically according to the memory changed. The following describes each item of this menu.

### Date

The date format is:

**Day :** Sun to Sat  
**Month :** 1 to 12  
**Date :** 1 to 31  
**Year :** 1999 to 2099

---

To set the date, highlight the “Date” field and use the PageUp/PageDown or +/- keys to set the current time.

### Time

The time format is:   **Hour** : 00 to 23  
                          **Minute** : 00 to 59  
                          **Second** : 00 to 59

To set the time, highlight the “Time” field and use the <PgUp>/<PgDn> or +/- keys to set the current time.

### IDE Channel Master/Slave

The onboard PCI IDE connector provides Primary and Secondary channels for connecting up to two IDE hard disks or other IDE devices.

Press <Enter> to configure the hard disk. The selections include Auto, Manual, and None. Select ‘Manual’ to define the drive information manually. You will be asked to enter the following items.

**CYLS** :                    Number of cylinders  
**HEAD** :                  Number of read/write heads  
**PRECOMP** :              Write precompensation  
**LANDING ZONE** :        Landing zone  
**SECTOR** :                Number of sectors

The Access Mode selections are as follows:

CHS   (HD < 528MB)  
LBA   (HD > 528MB and supports  
       Logical Block Addressing)  
Large   (for MS-DOS only)  
Auto

**Remarks:** The main board supports two serial ATA ports and are represented in this setting as IDE Channel 0.

### Video

This field selects the type of video display card installed in your system.

You can choose the following video display cards:

EGA/VGA	For EGA, VGA, SEGA, SVGA or PGA monitor adapters. (default)
CGA 40	Power up in 40 column mode.
CGA 80	Power up in 80 column mode.
MONO	For Hercules or MDA adapters.

### Halt On

This field determines whether or not the system will halt if an error is detected during power up.

No errors	The system boot will not be halted for any error that may be detected.
All errors	Whenever the BIOS detects a non-fatal error, the system will stop and you will be prompted.
All, But Keyboard	The system boot will not be halted for a keyboard error; it will stop for all other errors
All, But Diskette	The system boot will not be halted for a disk error; it will stop for all other errors.
All, But Disk/Key	The system boot will not be halted for a keyboard or disk error; it will stop for all others.

## Advanced BIOS Features

This section allows you to configure and improve your system and allows you to set up some system features according to your preference.

Phoenix - AwardBIOS CMOS Setup Utility  
Advanced BIOS Features

		ITEM HELP
CPU Feature	Press Enter	
Hard Disk Boot Priority	Press Enter	
Virus Warning	Disabled	Menu Level >
CPU L1 and L2 Cache	Enabled	
CPU L3	Enabled	
Hyper-Threading Technology	Enabled	
Quick Power On Self Test	Enabled	
First Boot Device	Hard Disk	
Second Boot Device	CDROM	
Third Boot Device	USB-CDROM	
Boot Other Device	Enabled	
Boot Up NumLock Status	On	
Gate A20 Option	Fast	
Typeomatic Rate Setting	Disabled	
Typeomatic Rate (Chars/Sec)	6	
Typeomatic Delay (Msec)	250	
Security Option	Setup	
APIC Mode	Enabled	
MPS Version Control for OS	1.4	
OS Select For DRAM>64MB	Non-OS2	
Small Logo (EPA) Show	Disabled	

### CPU Feature

Press Enter to configure the settings relevant to CPU Feature.

### Hard Disk Boot Priority

With the field, there is the option to choose, aside from the hard disks connected, "Bootable add-in Cards" which refers to other external devices.

### Virus Warning

If this option is enabled, an alarm message will be displayed when trying to write on the boot sector or on the partition table on the disk, which is typical of the virus.

### CPU L1/L2/L3 Cache

Cache memory is additional memory that is faster than conventional DRAM (system memory). CPUs from 486-type on up contain internal cache memory, and most, but not all, modern PCs have additional (external) cache memory. When the CPU requests data, the system transfers the requested data from the main DRAM into cache memory, for even faster access by the CPU. These allow you to enable (speed up memory access) or disable the cache function.

### **Hyper-Threading Technology**

By default, this field is enabled.

### **Quick Power On Self Test**

When enabled, this field speeds up the Power On Self Test (POST) after the system is turned on. If it is set to *Enabled*, BIOS will skip some items.

### **First/Second/Third Boot Device**

These fields determine the drive that the system searches first for an operating system. The options available include *LS120*, *Hard Disk*, *CDROM*, *ZIP100*, *USB-Floppy*, *USB-ZIP*, *USB-CDROM*, *LAN* and *Disable*.

### **Boot Other Device**

These fields allow the system to search for an OS from other devices other than the ones selected in the First/Second/Third Boot Device.

### **Boot Up NumLock Status**

This allows you to activate the NumLock function after you power up the system.

### **Gate A20 Option**

This field allows you to select how Gate A20 is worked. Gate A20 is a device used to address memory above 1 MB.

### **Typematic Rate Setting**

When disabled, continually holding down a key on your keyboard will generate only one instance. When enabled, you can set the two typematic controls listed next. By default, this field is set to *Disabled*.

### **Typematic Rate (Chars/Sec)**

When the typematic rate is enabled, the system registers repeated keystrokes speeds. Settings are from 6 to 30 characters per second.

### **Typematic Delay (Msec)**

When the typematic rate is enabled, this item allows you to set the time interval for displaying the first and second characters. By default, this item is set to *250msec*.

**Security Option**

This field allows you to limit access to the System and Setup. The default value is *Setup*. When you select *System*, the system prompts for the User Password every time you boot up. When you select *Setup*, the system always boots up and prompts for the Supervisor Password only when the Setup utility is called up.

**APIC Mode**

APIC stands for Advanced Programmable Interrupt Controller. The default setting is *Enabled*.

**MPS Version Control for OS**

This option specifies the MPS (Multiprocessor Specification) version for your operating system. MPS version 1.4 added extended configuration tables to improve support for multiple PCI bus configurations and improve future expandability. The default setting is 1.4.

**OS Select for DRAM > 64MB**

This option allows the system to access greater than 64MB of DRAM memory when used with OS/2 that depends on certain BIOS calls to access memory. The default setting is *Non-OS/2*.

**Small Logo (EPA) Show**

The EPA logo appears at the right side of the monitor screen when the system is boot up.

## Advanced Chipset Features

This Setup menu controls the configuration of the chipset.

Phoenix - AwardBIOS CMOS Setup Utility  
Advanced Chipset Features

		ITEM HELP
DRAM Timing Selectable	By SPD	Menu Level >
CAS Latency Time	Auto	
DRAM RAS# to CAS# Delay	Auto	
DRAM RAS# Precharge	Auto	
Precharge delay (tRAS)	Auto	
System Memory Frequency	Auto	
SLP_S4# Assertion Width	1 to 2 Sec	
System BIOS Cacheable	Enabled	
Video BIOS Cacheable	Disabled	
Memory Hole at 15M-16M	Disabled	
PCI Express Root Port Func	Press Enter	
** On-Chip VGA Setting **		
On-Chip Frame Buffer Size	8MB	
DVMT Mode	DVMT	
DVMT/FIXED memory Size	128MB	
Boot Display	CRT+LVDS	
Panel Scaling	Auto	
Panel Number	1024x768 18 bit SC	

### DRAM Timing Selectable

This option refers to the method by which the DRAM timing is selected. The default is **By SPD**.

### CAS Latency Time

You can configure CAS latency time in HCLKs as 2 or 2.5 or 3. The system board designer should set the values in this field, depending on the DRAM installed. Do not change the values in this field unless you change specifications of the installed DRAM or the installed CPU.

### DRAM RAS# to CAS# Delay

This option allows you to insert a delay between the RAS (Row Address Strobe) and CAS (Column Address Strobe) signals. This delay occurs when the SDRAM is written to, read from or refreshed. Reducing the delay improves the performance of the SDRAM.

**DRAM RAS# Precharge**

This option sets the number of cycles required for the RAS to accumulate its charge before the SDRAM refreshes. The default setting for the Active to Precharge Delay is *Auto*.

**Precharge Delay (tRAS)**

The default setting for the Precharge Delay is *Auto*.

**System Memory Frequency**

The default setting is *Auto*.

**SLP\_S4# Assertion Width**

The default setting is *4 to 5 Sec*.

**System BIOS Cacheable**

The setting of *Enabled* allows caching of the system BIOS ROM at F000h-FFFFh, resulting in better system performance. However, if any program writes to this memory area, a system error may result.

**Video BIOS Cacheable**

The Setting *Enabled* allows caching of the video BIOS ROM at C0000h-F7FFFh, resulting in better video performance. However, if any program writes to this memory area, a system error may result.

**Memory Hole At 15M-16M**

In order to improve performance, certain space in memory can be reserved for ISA cards. This memory must be mapped into the memory space below 16 MB. The choices are *Enabled* and *Disabled*.

**On-Chip VGA Setting**

The fields under the On-Chip VGA Setting and their default settings are:

- On-Chip Frame Buffer Size: 8MB
- DVMT Mode: DVMT
- DVMT/Fixed Memory Size: 128MB
- Boot Display: CRT+LVDS
- Panel Scaling: Auto
- Panel Number: 1024x768 18 bit SC

### Panel Scaling

The default setting is *Auto*. The options available include *On* and *Off*.

### Panel Number

These fields allow you to select the LCD Panel type. The default values for these ports are:

640x480	18bit SC
800x480	18bit SC
800x600	18bit SC
1024x768	18bit SC
1280x768	18bit SC
1280x800	18bit SC
1366x768	18bit SC

## Integrated Peripherals

This section sets configurations for your hard disk and other integrated peripherals. The first screen shows three main items for user to select. Once an item selected, a submenu appears. Details follow.

Phoenix - AwardBIOS CMOS Setup Utility  
Integrated Peripherals

OnChip IDE Device	Press Enter	ITEM HELP
Onboard Device	Press Enter	Menu Level >
SuperIO Device	Press Enter	

Phoenix - AwardBIOS CMOS Setup Utility  
**OnChip IDE Device**

IDE HDD Block Mode	Enabled	ITEM HELP
IDE DMA Transfer Access	Enabled	Menu Level >
On-chip Primary PCI IDE	Auto	
IDE Primary Master PIO	Auto	
IDE Primary Slave PIO	Auto	
IDE Primary Master UDMA	Auto	
IDE Primary Slave UDMA	Auto	
On-Chip Secondary PCI IDE	Enabled	
IDE Secondary Master PIO	Auto	
IDE Secondary Slave PIO	Auto	
IDE Secondary Master UDMA	Auto	
IDE Secondary Slave UDMA	Auto	
*** On-Chip Serial ATA Setting ***		
On-Chip Serial ATA	Auto	
SATA PORT Speed ATA	Disabled	
PATA IDE Mode	Secondary	
SATA port	P0, P2 is Primary	

Phoenix - AwardBIOS CMOS Setup Utility  
**Onboard Device**

USB Controller	Enabled	ITEM HELP
USB 2.0 Controller	Enabled	Menu Level >
USB Keyboard Support	Disabled	
USB Mouse Support	Disabled	
Azalia/AC97 Audio Select	Auto	

Onboard Serial Port 1	3F8/IRQ4	ITEM HELP
Onboard Serial Port 2	2F8/IRQ3	
PWRON After PWR-Fail	Off	Menu Level >

**IDE HDD Block Mode**

This field allows your hard disk controller to use the fast block mode to transfer data to and from your hard disk drive.

**IDE DMA Transfer Access**

By default, this field is enabled.

**On-chip Primary PCI IDE Enabled**

By default, this field is enabled.

**OnChip Primary/Secondary PCI IDE**

The integrated peripheral controller contains an IDE interface with support for two IDE channels. Select *Enabled* to activate each channel separately.

**IDE Primary/Secondary Master/Slave PIO**

These fields allow your system hard disk controller to work faster. Rather than have the BIOS issue a series of commands that transfer to or from the disk drive, PIO (Programmed Input/Output) allows the BIOS to communicate with the controller and CPU directly.

The system supports five modes, numbered from 0 (default) to 4, which primarily differ in timing. When Auto is selected, the BIOS will select the best available mode.

**IDE Primary/Secondary Master/Slave UDMA**

These fields allow your system to improve disk I/O throughput to 33Mb/sec with the Ultra DMA/33 feature. The options are *Auto* and *Disabled*.

**On-Chip Serial ATA Setting**

The fields under the SATA setting includes On-Chip Serial ATA (Auto), PATA IDE Mode (Secondary) and SATA Port (PO, P2 is Primary).

**USB Controller**

The options for this field are *Enabled* and *Disabled*. By default, this field is set to *Enabled*.

**USB 2.0 Controller**

The options for this field are *Enabled* and *Disabled*. By default, this field is set to *Enabled*. In order to use USB 2.0, necessary OS drivers must be installed first. *Please update your system to Windows 2000 SP4 or Windows XP SP2.*

**USB Keyboard Support**

The options for this field are *Enabled* and *Disabled*.

**USB Mouse Support**

The options for this field are *Enabled* and *Disabled*.

**Azalia/AC97 Audio Select**

This field, by default, is set to *Auto*.

**Onboard Serial Port**

These fields allow you to select the onboard serial ports and their addresses. The default values for these ports are:

Serial Port 1	3F8/IRQ4
Serial Port 2	2F8/IRQ3

**PWRON After PWR-Fail**

This field sets the system power status whether *on* or *off* when power returns to the system from a power failure situation.

## Power Management Setup

Phoenix - AwardBIOS CMOS Setup Utility  
Power Management Setup

		ITEM HELP
ACPI Function	Enabled	
ACPI Suspend	S1(POS)	
RUN VGABIOS if S3 Resume	Auto	
Power Management	User Define	Menu Level >
Video Off Method	DPMS	
Video Off In Suspend	Yes	
Suspend Type	Stop Grant	
Modem Use IRQ	3	
Suspend Mode	Disabled	
HDD Power Down	Disabled	
Soft-Off by PWR-BTTN	Instant-Off	
CPU THRM-Throttling	75%	
Wake-Up by PCI Card	Disabled	
USB KB Wake-Up From S3	Disabled	
Resume by Alarm	Disabled	
Date (of Month) Alarm	0	
Time (hh:mm:ss) Alarm	0 : 0 : 0	
** Reload Global Timer Events **		
Primary IDE 0	Disabled	
Primary IDE 1	Disabled	
Secondary IDE 0	Disabled	
Secondary IDE 1	Disabled	
FDD, COM, LPT Port	Disabled	
PCI PIRQ[A-D] #	Disabled	

### ACPI Function

Enable this function to support ACPI (Advance Configuration and Power Interface).

### ACPI Suspend

The default setting of the ACPI Suspend mode is *S1(POS)*.

### RUN VGABIOS if S3 Resume

The default setting of this field is *Auto*.

### Power Management

This field allows you to select the type of power saving management modes. There are four selections for Power Management.

Min. Power Saving	Minimum power management
Max. Power Saving	Maximum power management.
User Define	Each of the ranges is from 1 min. to 1hr. Except for HDD Power Down which ranges from 1 min. to 15 min.

### Video Off Method

This field defines the Video Off features. There are three options.

V/H SYNC + Blank	Default setting, blank the screen and turn off vertical and horizontal scanning.
DPMS	Allows BIOS to control the video display.
Blank Screen	Writes blanks to the video buffer.

### Video Off In Suspend

When enabled, the video is off in suspend mode. The default setting is *Yes*.

### Suspend Type

The default setting for the Suspend Type field is *Stop Grant*.

### Modem Use IRQ

This field sets the IRQ used by the Modem. By default, the setting is **3**.

### Suspend Mode

When enabled, and after the set time of system inactivity, all devices except the CPU will be shut off.

### HDD Power Down

When enabled, and after the set time of system inactivity, the hard disk drive will be powered down while all other devices remain active.

### Soft-Off by PWRBTN

This field defines the power-off mode when using an ATX power supply. The *Instant Off* mode allows powering off immediately upon pressing the power button. In the *Delay 4 Sec* mode, the system powers off when the power button is pressed for more than four seconds or enters the suspend mode when pressed for less than 4 seconds.

### **CPU THRM-Throttling**

By default, this field is set to **75%**.

### **Wake up by PCI Card**

By default, this field is disabled.

### **USB KB Wakeup from S3**

By default, this field is disabled.

### **Resume by Alarm**

This field enables or disables the resumption of the system operation. When enabled, the user is allowed to set the *Date* and *Time*.

### **Reload Global Timer Events**

The HDD, FDD, COM, LPT Ports, and PCI PIRQ are I/O events that can prevent the system from entering a power saving mode or can awaken the system from such a mode. When an I/O device wants to gain the attention of the operating system, it signals this by causing an IRQ to occur. When the operating system is ready to respond to the request, it interrupts itself and performs the service.

## PNP/PCI Configurations

This option configures the PCI bus system. All PCI bus systems on the system use INT#, thus all installed PCI cards must be set to this value.

Phoenix - AwardBIOS CMOS Setup Utility  
PnP/PCI Configurations

Init Display First	PCI Slot	ITEM HELP
Reset Configuration Data	Disabled	
Resources Controlled By	Auto (ESCD)	Menu Level
IRQ Resources	Press Enter	Select Yes if you are using a Plug and Play capable operating system Select No if you need the BIOS to configure non-boot devices
PCI/VGA Palette Snoop	Disabled	
**PCI Express relative items**		
Maximum Payload Size	128	

### Init Display First

The default setting is *PCI Slot*.

### Reset Configuration Data

This field allows you to determine whether to reset the configuration data or not. The default value is *Disabled*.

### Resources Controlled by

This PnP BIOS can configure all of the boot and compatible devices with the use of a PnP operating system such as Windows 95.

### PCI/VGA Palette Snoop

Some non-standard VGA display cards may not show colors properly. This field allows you to set whether or not MPEG ISA/VESA VGA cards can work with PCI/VGA. When this field is enabled, a PCI/VGA can work with an MPEG ISA/VESA VGA card. When this field is disabled, a PCI/VGA cannot work with an MPEG ISA/VESA card.

### Maximum Payload Size

The default setting of the PCI Express Maximum Payload Size is 128.

## PC Health Status

This section shows the parameters in determining the PC Health Status. These parameters include temperatures, fan speeds and voltages.

Phoenix - AwardBIOS CMOS Setup Utility  
PC Health Status

		ITEM HELP
Shutdown Temperature	Disabled	
CPU Warning Temperature	Disabled	
Current System Temp	45°C/113°F	
Current CPU Temp	45°C/113°F	Menu Level >
Fan1 Speed	0 RPM	
Vcore(V)	1.02 V	
+12V	12.40 V	
1.8V	1.8V	
+5V	5.07V	
3.3V	3.37V	
VBAT (V)	3.21 V	
5VSB(V)	5.67 V	
** Smart FAN I **		
LCD Back Light Control	63	

### Shutdown Temperature

This field allows the user to set the temperature by which the system automatically shuts down once the threshold temperature is reached. This function can help prevent damage to the system that is caused by overheating.

### CPU Warning Temperature

This field allows the user to set the temperature so that when the temperature is reached, the system sounds a warning. This function can help prevent damage to the system that is caused by overheating.

### Temperatures/Voltages

These fields are the parameters of the hardware monitoring function feature of the board. The values are read-only values as monitored by the system and show the PC health status.

## Frequency/Voltage Control

This section shows the user how to configure the processor frequency.

Phoenix - AwardBIOS CMOS Setup Utility  
Frequency/Voltage Control

Auto Detect PCI Clk	Enabled	ITEM HELP
Spread Spectrum	Disabled	Menu Level >
CPU Host/SRC PCI Clock	Default	

### Auto Detect PCI Clk

This field enables or disables the auto detection of the PCI clock.

### Spread Spectrum Modulated

This field sets the value of the spread spectrum. The default setting is **Disabled**. This field is for CE testing use only.

### CPU Host / SRC PCI Clock

This field is set to **Default**.

### **Load Fail-Safe Defaults**

This option allows you to load the troubleshooting default values permanently stored in the BIOS ROM. These default settings are non-optimal and disable all high-performance features.

### **Load Optimized Defaults**

This option allows you to load the default values to your system configuration. These default settings are optimal and enable all high performance features.

### **Set Supervisor Password**

These two options set the system password. Supervisor Password sets a password that will be used to protect the system and Setup utility. User Password sets a password that will be used exclusively on the system. To specify a password, highlight the type you want and press <Enter>. The Enter Password: message prompts on the screen. Type the password, up to eight characters in length, and press <Enter>. The system confirms your password by asking you to type it again. After setting a password, the screen automatically returns to the main screen.

To disable a password, just press the <Enter> key when you are prompted to enter the password. A message will confirm the password to be disabled. Once the password is disabled, the system will boot and you can enter Setup freely.

### **Save & Exit Setup**

This option allows you to determine whether or not to accept the modifications. If you type “Y”, you will quit the setup utility and save all changes into the CMOS memory. If you type “N”, you will return to Setup utility.

### **Exit Without Saving**

Select this option to exit the Setup utility without saving the changes you have made in this session. Typing “Y” will quit the Setup utility without saving the modifications. Typing “N” will return you to Setup utility.

## Drivers Installation

This section describes the installation procedures for software and drivers under the Windows 2000 and Windows XP. The software and drivers are included with the board. If you find the items missing, please contact the vendor where you made the purchase. The contents of this section include the following:

Intel Chipset Software Installation Utility .....	38
Intel Graphics Driver Installation .....	39
Realtek HD Codec Audio Driver Installation.....	40
Intel PRO LAN Drivers Installation .....	42

**IMPORTANT NOTE:**

After installing your Windows operating system (Windows 2000/ XP), you must install first the Intel Chipset Software Installation Utility before proceeding with the drivers installation.

## Intel Chipset Software Installation Utility

---

The Intel Chipset Drivers should be installed first before the software drivers to enable Plug & Play INF support for Intel chipset components. Follow the instructions below to complete the installation under Windows 2000/XP.

1. Insert the CD that comes with the board. Click **Intel** at the left side, then **Intel(R) I945GM/GME/GSE Chipset Drivers**.
2. Click **Intel(R) Chipset Software Installation Utility**.



3. When the welcome screen to the Intel(R) Chipset Software Installation Utility appears, click **Next** to continue.
4. Click **Yes** to accept the software license agreement and proceed with the installation process.
5. On Readme Information screen, click **Next** to continue the installation.
6. The Setup process is now complete. Click **Finish** to restart the computer and for changes to take effect.

---

## Intel Graphics Driver Installation

---

To install the VGA drivers, follow the steps below to proceed with the installation.

1. Insert the CD that comes with the board. Click **Intel** at the left side, then **Intel(R) I945GM/GME/GSE Chipset Drivers**.
2. Click **Intel(R) I945GM/GME/GSE Chipset Family Graphics Driver**.

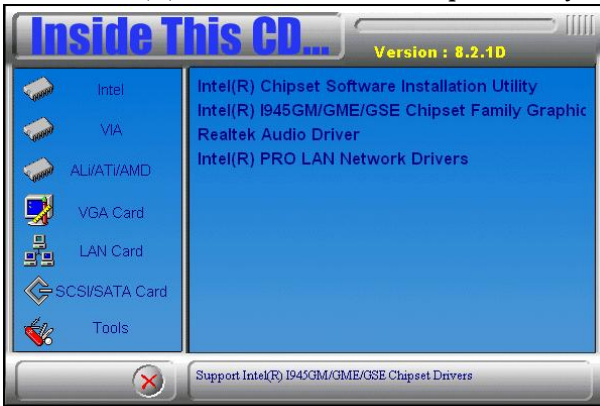

3. When the welcome screen of the Intel(R) Graphics Media Accelerator Driver appears, click **Next** to continue.
4. Click **Yes** to agree with the license agreement and continue the installation.
5. Click **Next** in the Readme File Information window.
6. Click **Next** in the Setup Progress window.
7. Setup is now complete. Click **Finish** to restart the computer and for changes to take effect.

## Realtek HD Codec Audio Driver Installation

Follow the steps below to install the Realtek HD Codec Audio Drivers.

1. Insert the CD that comes with the board. Click **Intel** and then **Intel(R) I945GM/GME/GSE Chipset Drivers**, and then **Realtek Audio Driver**.



2. Click **Realtek High Definition Codec Audio Driver**.



3. When the welcome screen to InstallShield Wizard for **Realtek High Definition Codec Audio Driver** appears, click **Next** to start the installation.

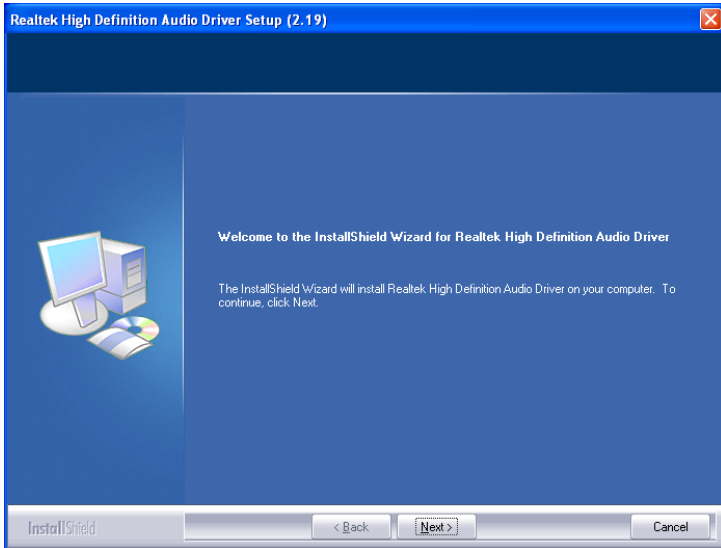

4. When the InstallShield Wizard has finished performing maintenance operations on Realtek High Definition Codec Audio Driver, click **Finish** to restart the computer.

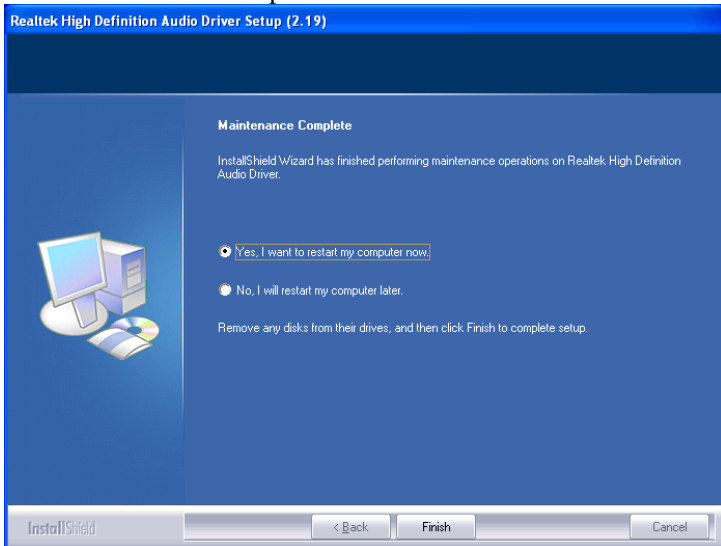

## Intel PRO LAN Drivers Installation

Follow the steps below to install Intel PRO LAN drivers.

1. Insert the CD that comes with the board. Click *LAN Card* at the left side and then *Intel(R) PRO 82574L LAN Drivers*.

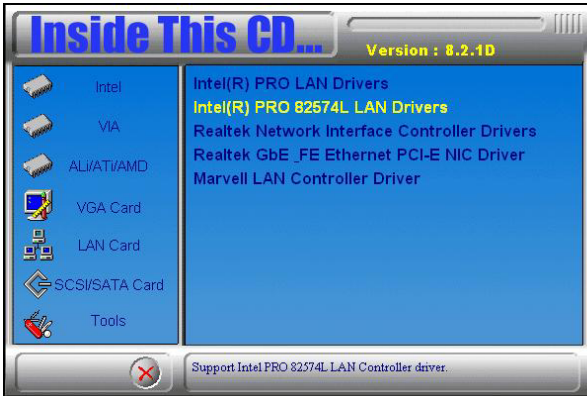

2. In the Intel® Network Connections screen\*, click *Install Drivers and Software*.

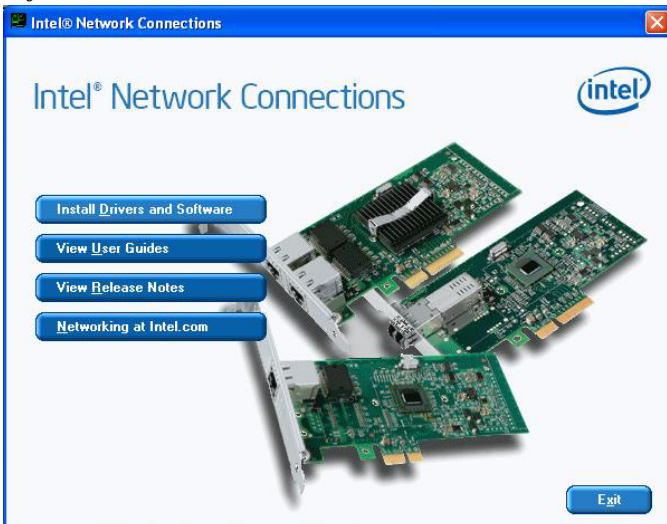

\*Under Windows 2000, driver installation will require the Windows Management Instrumentation Service running in order to proceed. Refer to this information at the end of this section.

3. In the welcome screen of the InstallShield Wizard for Intel(R) Network Connections, click *Next*.
4. In the Setup Options, click the checkbox as shown below and click *Next*.

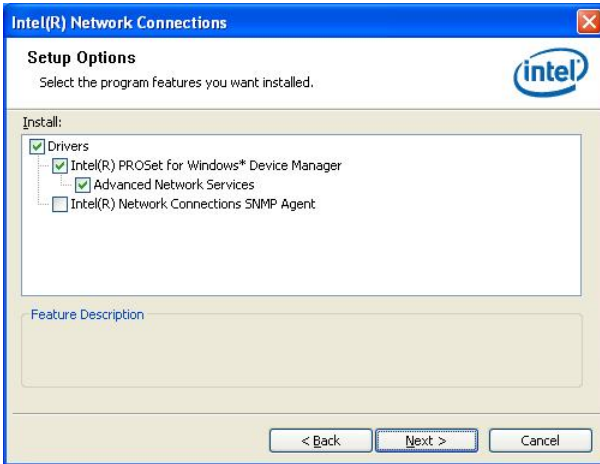

4. In the InstallShield Wizard screen, click *Install* to begin the installation.



5. InstallShield Wizard is completed. Click *Finish* to exit the Wizard.

### The Windows Management Instrumentation Service

During the installation of the *Intel(R) PRO 82574L LAN* drivers under Windows 2000, the message below asking to start the Windows Management Instrument Service will appear.



At this moment, click **OK**, and proceed to run the service requested. On the Windows desktop, right click the **My Computer** icon and click **Manage**.



When the Computer Management properties appear, double click **Services and Applications** tab at the bottom and then click **Services**. Double click two Services names including *Windows Management Instrumentation* and *Windows Management Instrumentation Driver Extensions* in order to configure their **Startup type** as **Automatic** as shown below. After this step, you can go back to install the LAN driver.

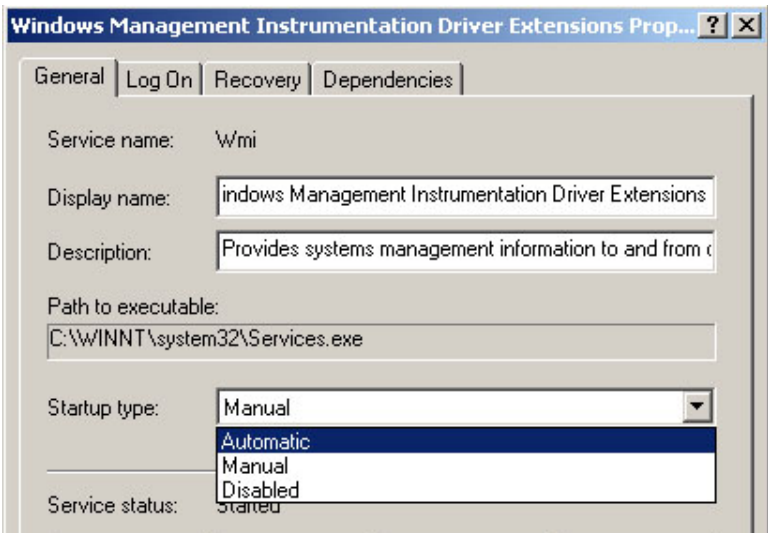
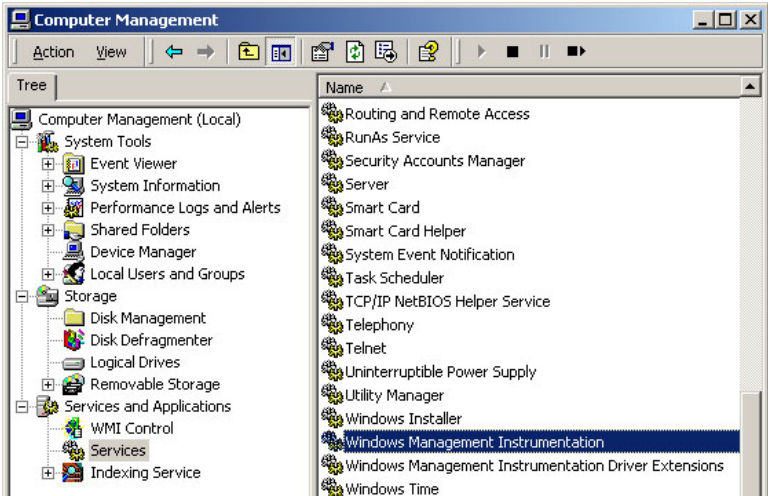

This page is intentionally left blank.

## Appendix

### A. I/O Port Address Map

Each peripheral device in the system is assigned a set of I/O port addresses that also becomes the identity of the device. The following table lists the I/O port addresses used.

Address	Device Description
000h - 01Fh	DMA Controller #1
020h - 03Fh	Interrupt Controller #1
040h - 05Fh	Timer
060h - 06Fh	Keyboard Controller
070h - 07Fh	Real Time Clock, NMI
080h - 09Fh	DMA Page Register
0A0h - 0BFh	Interrupt Controller #2
0C0h - 0DFh	DMA Controller #2
0F0h	Clear Math Coprocessor Busy Signal
0F1h	Reset Math Coprocessor
1F0h - 1F7h	IDE Interface
278 - 27F	Parallel Port #2(LPT2)
2F8h - 2FFh	Serial Port #2(COM2)
2B0 - 2DF	Graphics adapter Controller
378h - 3FFh	Parallel Port #1(LPT1)
360 - 36F	Network Ports
3B0 - 3BF	Monochrome & Printer adapter
3C0 - 3CF	EGA adapter
3D0 - 3DF	CGA adapter
3F0h - 3F7h	Floppy Disk Controller
3F8h - 3FFh	Serial Port #1(COM1)

## B. Interrupt Request Lines (IRQ)

Peripheral devices use interrupt request lines to notify CPU for the service required. The following table shows the IRQ used by the devices on board.

Level	Function
IRQ0	System Timer Output
IRQ1	Keyboard
IRQ2	Interrupt Cascade
IRQ3	Serial Port #2
IRQ4	Serial Port #1
IRQ5	Reserved
IRQ6	Floppy Disk Controller
IRQ7	Parallel Port #1
IRQ8	Real Time Clock
IRQ9	Reserved
IRQ10	Reserved
IRQ11	Reserved
IRQ12	PS/2 Mouse
IRQ13	80287
IRQ14	Primary IDE
IRQ15	Secondary IDE

## C. Watchdog Timer Configuration

The WDT is used to generate a variety of output signals after a user programmable count. The WDT is suitable for use in the prevention of system lock-up, such as when software becomes trapped in a deadlock. Under these sorts of circumstances, the timer will count to zero and the selected outputs will be driven. Under normal circumstance, the user will restart the WDT at regular intervals before the timer counts to zero.

### SAMPLE CODE:

```

=====
//
// THIS CODE AND INFORMATION IS PROVIDED "AS IS" WITHOUT WARRANTY OF ANY
// KIND, EITHER EXPRESSED OR IMPLIED, INCLUDING BUT NOT LIMITED TO THE
// IMPLIED WARRANTIES OF MERCHANTABILITY AND/OR FITNESS FOR A PARTICULAR
// PURPOSE.
//
=====
#include <stdio.h>
#include <stdlib.h>
#include "W627EHF.H"
=====
int main (int argc, char *argv[]);
void copyright(void);
void EnableWDT(int);
void DisableWDT(void);
=====
int main (int argc, char *argv[])
{
    unsigned char bBuf;
    unsigned char bTime;
    char **endptr;

    copyright();

    if (argc != 2)
    {
        printf(" Parameter incorrect!!\n");
        return 1;
    }

    if (Init_W627EHF() == 0)
    {
        printf(" Winbond 83627HF is not detected, program abort.\n");
        return 1;
    }
    bTime = strtol (argv[1], endptr, 10);
    printf("System will reset after %d seconds\n", bTime);

    EnableWDT(bTime);

    return 0;
}
=====

```

```

void copyright(void)
{
    printf("\n===== Winbond 83627EHF Watch Timer Tester (AUTO DETECT) =====\n")
        " Usage : W627E_WD reset_time\n"
        " Ex : W627E_WD 3 => reset system after 3 second\n"
        " W627E_WD 0 => disable watch dog timer\n");
}
//=====
void EnableWDT(int interval)
{
    unsigned char bBuf;

    bBuf = Get_W627EHF_Reg( 0x2D);
    bBuf &= (10x01);
    Set_W627EHF_Reg( 0x2D, bBuf); //Enable WDTO

    Set_W627EHF_LD( 0x08); //switch to logic device 8
    Set_W627EHF_Reg( 0x30, 0x01); //enable timer

    bBuf = Get_W627EHF_Reg( 0xF5);
    bBuf &= (10x08);
    Set_W627EHF_Reg( 0xF5, bBuf); //count mode is second

    Set_W627EHF_Reg( 0xF6, interval); //set timer
}
//=====
void DisableWDT(void)
{
    Set_W627EHF_LD(0x08); //switch to logic device 8
    Set_W627EHF_Reg(0xF6, 0x00); //clear watchdog timer
    Set_W627EHF_Reg(0x30, 0x00); //watchdog disabled
}
//=====

```

```

//=====
//
// THIS CODE AND INFORMATION IS PROVIDED "AS IS" WITHOUT WARRANTY OF ANY
// KIND, EITHER EXPRESSED OR IMPLIED, INCLUDING BUT NOT LIMITED TO THE
// IMPLIED WARRANTIES OF MERCHANTABILITY AND/OR FITNESS FOR A PARTICULAR
// PURPOSE.
//
//=====
#include "W627EHF.H"
#include <dos.h>
//=====
unsigned int W627EHF_BASE;
void Unlock_W627EHF (void);
void Lock_W627EHF (void);
//=====
unsigned int Init_W627EHF(void)
{
    unsigned int result;
    unsigned char ucDid;

    W627EHF_BASE = 0x2E;
    result = W627EHF_BASE;

    ucDid = Get_W627EHF_Reg(0x20);
    if (ucDid == 0x88)
    {
        goto Init_Finish;
    }

    W627EHF_BASE = 0x4E;
    result = W627EHF_BASE;
    ucDid = Get_W627EHF_Reg(0x20);
    if (ucDid == 0x88)
    {
        goto Init_Finish;
    }

    W627EHF_BASE = 0x00;
    result = W627EHF_BASE;

Init_Finish:
    return (result);
}
//=====
void Unlock_W627EHF (void)
{
    outportb(W627EHF_INDEX_PORT, W627EHF_UNLOCK);
    outportb(W627EHF_INDEX_PORT, W627EHF_UNLOCK);
}
//=====
void Lock_W627EHF (void)
{
    outportb(W627EHF_INDEX_PORT, W627EHF_LOCK);
}
//=====
void Set_W627EHF_LD( unsigned char LD)
{
    Unlock_W627EHF();
    outportb(W627EHF_INDEX_PORT, W627EHF_REG_LD);
    outportb(W627EHF_DATA_PORT, LD);
    Lock_W627EHF();
}

```

```

=====
void Set_W627EHF_Reg( unsigned char REG, unsigned char DATA)
{
    Unlock_W627EHF();
    outportb(W627EHF_INDEX_PORT, REG);
    outportb(W627EHF_DATA_PORT, DATA);
    Lock_W627EHF();
}
=====
unsigned char Get_W627EHF_Reg(unsigned char REG)
{
    unsigned char Result;
    Unlock_W627EHF();
    outportb(W627EHF_INDEX_PORT, REG);
    Result = inportb(W627EHF_DATA_PORT);
    Lock_W627EHF();
    return Result;
}
=====

//=====
//
// THIS CODE AND INFORMATION IS PROVIDED "AS IS" WITHOUT WARRANTY OF ANY
// KIND, EITHER EXPRESSED OR IMPLIED, INCLUDING BUT NOT LIMITED TO THE
// IMPLIED WARRANTIES OF MERCHANTABILITY AND/OR FITNESS FOR A PARTICULAR
// PURPOSE.
//
//=====
#ifndef __W627EHF_H
#define __W627EHF_H                1
//=====
#define W627EHF_INDEX_PORT      (W627EHF_BASE)
#define W627EHF_DATA_PORT      (W627EHF_BASE+1)
//=====
#define W627EHF_REG_LD          0x07
//=====
#define W627EHF_UNLOCK          0x87
#define W627EHF_LOCK            0xAA
//=====
unsigned int Init_W627EHF(void);
void Set_W627EHF_LD( unsigned char);
void Set_W627EHF_Reg( unsigned char, unsigned char);
unsigned char Get_W627EHF_Reg( unsigned char);
//=====
#endif // __W627EHF_H

```